

**■ General Description**

The AM2406 is a 1.5MHz constant frequency; slope compensated current mode PWM step-down converter. The device integrates a main switch and a synchronous rectifier for high efficiency without an external Schottky diode. It is ideal for powering portable equipment that runs from a single cell lithium-Ion (Li+) battery. The AM2406 can supply 600mA of load current from a 2.5V to 5.5V input voltage. The output voltage can be regulated as low as 0.6V. The AM2406 can also run at 100% duty cycle for low dropout operation, extending battery life in portable system. Idle mode operation at light loads provides very low output ripple voltage for noise sensitive applications.

The AM2406 is offered in a low profile (1mm) 5-pin, SOT package, and is available in an adjustable version and fixed output voltage of 1.2V, 1.5V and 1.8V.

**■ Applications**

- Cellular and Smart Phones
- PDAs
- MP3 Player
- Digital Still and Video Cameras
- Portable instruments
- Microprocessors and DSP Core Supplies
- Wireless and DSL Modems

**■ Features**

- High Efficiency : Up to 96%
- 1.5MHz Constant Switching Frequency
- 600mA Output Current at  $V_{IN}=3.0V$
- Integrated Main switch and synchronous rectifier. No Schottky Diode Required
- 2.5V to 5.5V Input Voltage Range
- Output Voltage as low as 0.6V
- 100% Duty Cycle in Dropout
- Low Quiescent Current : 20 $\mu A$
- <1 $\mu A$  Shutdown Current
- Slope Compensated Current Mode Control for Excellent Line and Load Transient Response
- Short Circuit and Thermal Fault Protection
- Space Saving 5-pin Thin SOT23 package

**■ Pin Configuration**

(Top View)

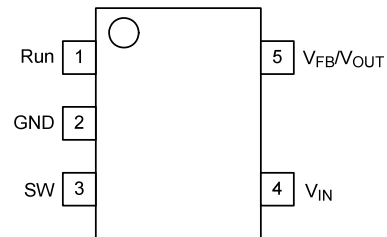
**■ Pin Description**

Pin Number	Pin Name	Pin Function
1	RUN	Regulator Enable control input. Drive RUN above 1.5V to turn on the part. Drive RUN below 0.3V to turn it off. In shutdown, all functions are disable drawing <1 $\mu A$ supply current. Do not leave RUN floating.
2	GND	Ground
3	SW	Power Switch Output. It is the Switch node connection to inductor. This pin connects to the drains of the internal P-CH and N-CH MOSFET switches.
4	IN	Supply Input Pin. Must be closely decoupled to GND, pin2, with a 2.2 $\mu F$ or greater ceramic capacitor.
5	FB/VOUT	VFB (AM2406) : Feedback Input Pin. Connected FB to the center point of the external resistor divider. The feedback threshold voltage is 0.6V. VOUT (AM2406- 1.2/1.5/1.8): Output Voltage Feedback Pin. An internal resistive divider divides the output voltage down for comparison to the internal reference voltage.

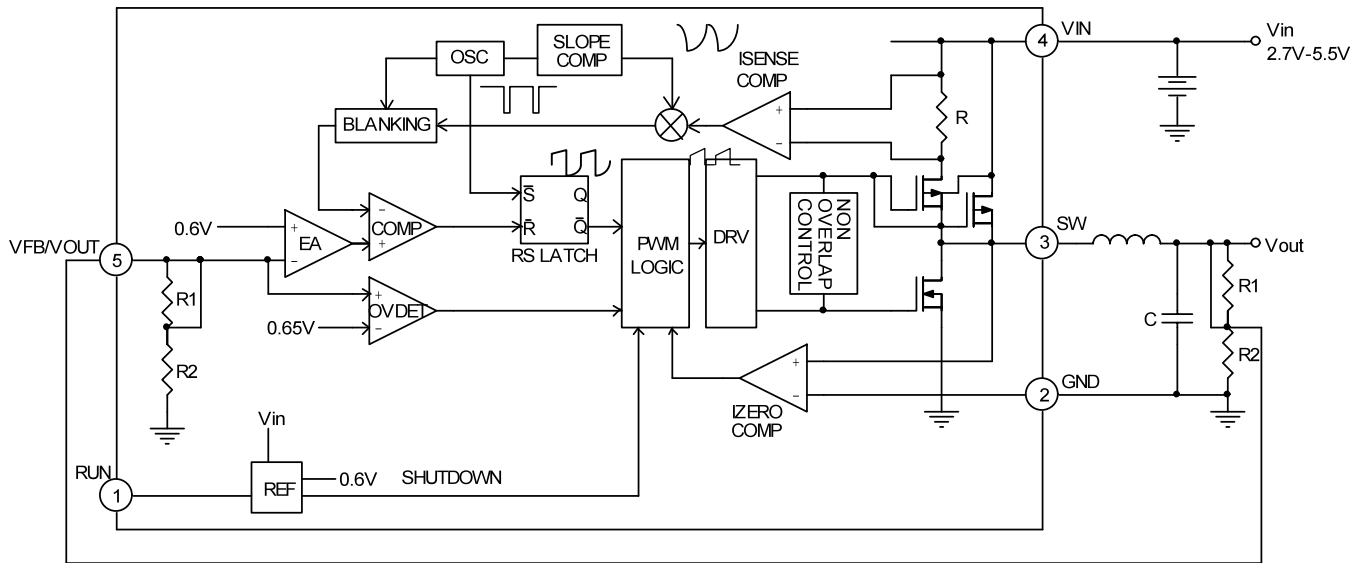
**■ Block Diagram**

For Adjustable Output R1+R2 is external.

**■ Thermal Resistance (Note 1)**

Package	$\theta_{JA}$ (°C/W)	$\theta_{JC}$ (°C/W)
TSOT23-5L	250	110

Note 1: Thermal Resistance is specified with approximately 1 square of 1 oz cooper.

**■ Absolute Maximum Ratings (Note 2)**

Parameter	Rating	Unit
Input Supply Voltage	-0.3 to +6	V
RUN, $V_{FB}$ Voltages	-0.3 to $V_{IN} + 0.3$	V
SW, $V_{out}$ Voltages	-0.3 to $V_{IN} + 0.3$	V
Peak SW Sink and Source Current	1.5	A
Operating Temperature Range	-40 to +85	°C
Junction Temperature (Note 3)	+125	°C
Storage Temperature Range	-65 to 150	°C
Lead Temperature (soldering, 10 sec.)	+300	°C

Note 2: Absolute Maximum Ratings are those values beyond which the life of a device may be impaired.

Note 3:  $T_J$  is calculated from the ambient temperature  $T_A$  and power dissipation  $P_D$  according to the following formula:

$$T_J = T_A + P_D \times \theta_{JA}$$

**■ Electrical Characteristics (Note 4)**

 ( $V_{IN}=V_{RUN}=3.6V$ ,  $T_A=25^\circ C$ , Unless otherwise noted)

Parameter	Condition	Min.	Typ.	Max.	Unit
Input Voltage Range		2.5		5.5	V
Input DC Supply Current Active Mode Shutdown Mode	$V_{FB}=0.5V$ $V_{FB}=0V, V_{IN}=4.2V$		270 0.08	400 1.0	$\mu A$
Regulated Feedback Voltage	$T_A=+25^\circ C$	0.5880	0.6000	0.6120	V
	$T_A=0^\circ C \leq T_A \leq 85^\circ C$	0.5865	0.6000	0.6135	V
	$T_A=-40^\circ C \leq T_A \leq 85^\circ C$	0.5850	0.6000	0.6150	V
$V_{FB}$ Input Bias Current	$V_{FB}=0.65V$			$\pm 30$	nA
Reference Voltage Line Regulation	$V_{IN}=2.5V$ to $5.5V$ , $V_{OUT}=V_{FB}$ ( $R2=0$ )		0.11	0.40	%/V
Regulated Output Voltage	AM2406- 1.2V: $-40^\circ C \leq T_A \leq 85^\circ C$	1.164	1.200	1.236	V
	AM2406- 1.5V: $-40^\circ C \leq T_A \leq 85^\circ C$	1.455	1.500	1.545	V
	AM2406- 1.8V: $-40^\circ C \leq T_A \leq 85^\circ C$	1.746	1.800	1.854	V
Output Voltage Line Regulation	$V_{IN}=2.5V$ to $5.5V$ , $I_{OUT}=10mA$		0.11	0.40	%/V
Output Voltage Load Regulation	$I_{OUT}$ from 0 to 600mA		0.0015		%/mA
Maximum Output Current	$V_{IN}=3.0V$	600			mA
Oscillator Frequency	$V_{FB}=0.6V$ or $V_{OUT}=100\%$	1.2	1.5	1.8	MHz
$R_{DS(ON)}$ of P-CH MOSFET	$I_{SW}=300mA$		0.30	0.50	$\Omega$
$R_{DS(ON)}$ of N-CH MOSFET	$I_{SW}=-300mA$		0.20	0.45	$\Omega$
Peak Inductor Current	$V_{IN}=3V$ , $V_{FB}=0.5V$ or $V_{OUT}=90\%$ , Duty Cycle < 35%		1.20		A
SW Leakage	$V_{RUN}=0V$ , $V_{SW}=0V$ or $5V$ , $V_{IN}=5V$		$\pm 0.01$	$\pm 1$	$\mu A$
Output over voltage lockout	$\Delta V_{OVL}=V_{OVL}-V_{FB}$		60		mV
RUN Threshold	$-40^\circ C \leq T_A \leq 85^\circ C$	0.3	0.45	1.30	V
RUN Leakage Current			$\pm 0.1$	$\pm 1$	$\mu A$

 Note 4: 100% production test at  $+25^\circ C$ . Specifications over the temperature range are guaranteed by design and characterization.

■ **Typical Performance Characteristics**  
(Test Figure 1 below unless otherwise specified)

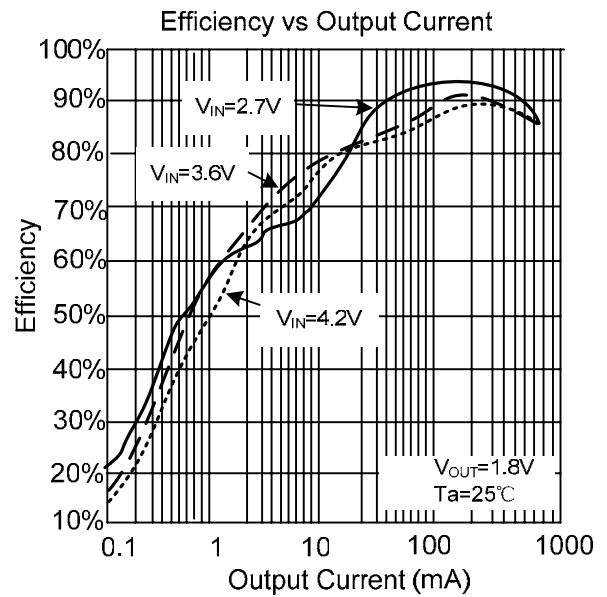
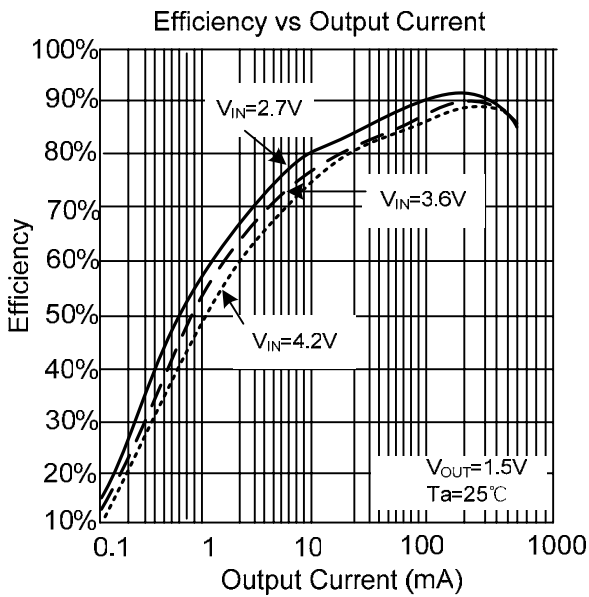
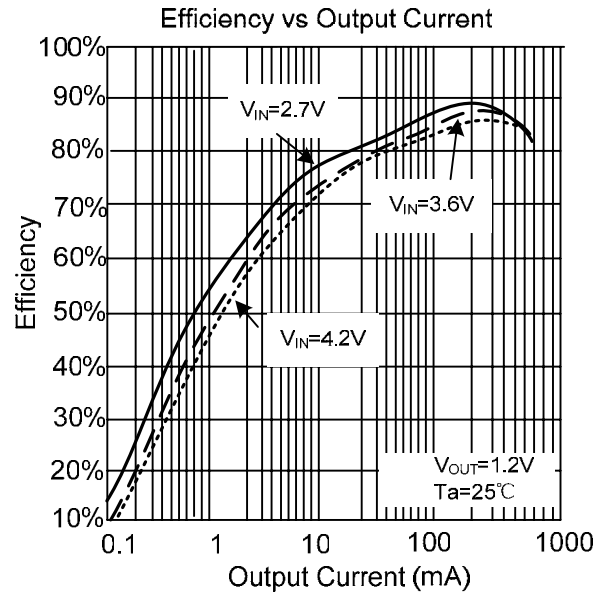
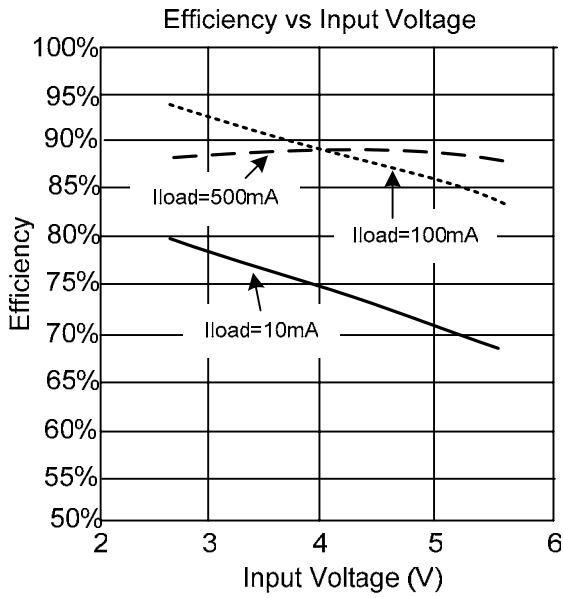

■ Typical Performance Characteristics (Continued)

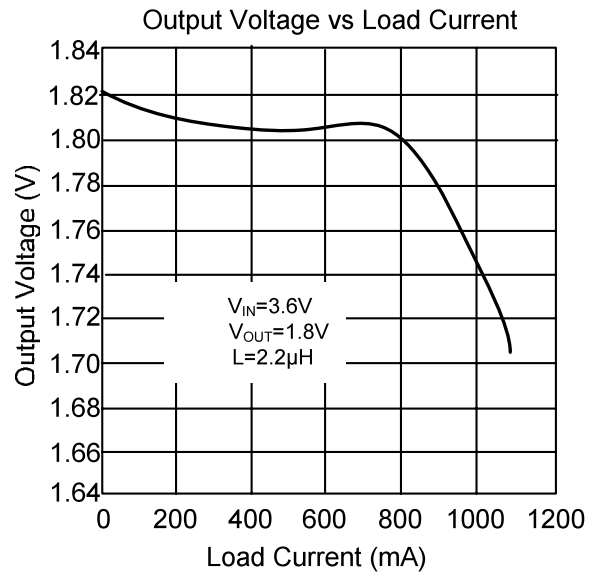
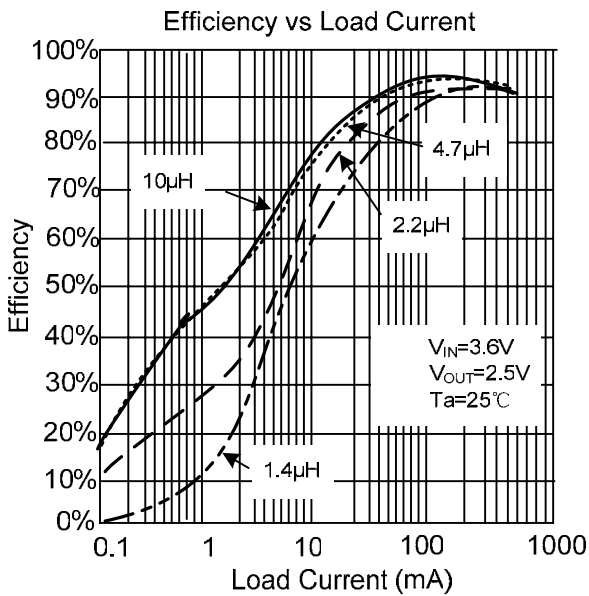
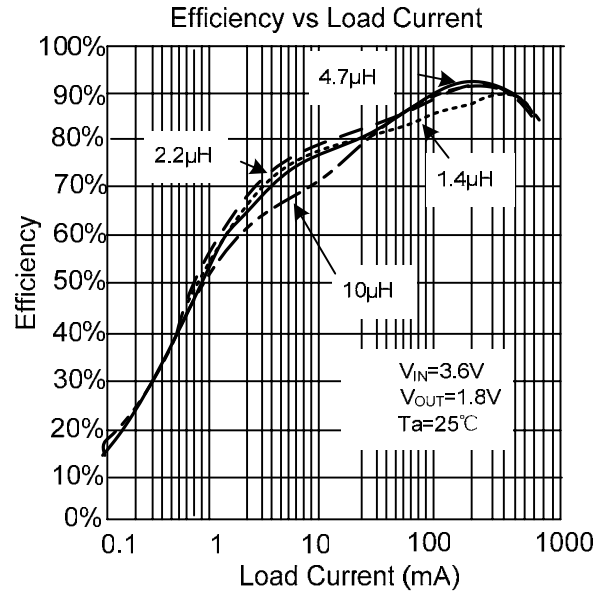
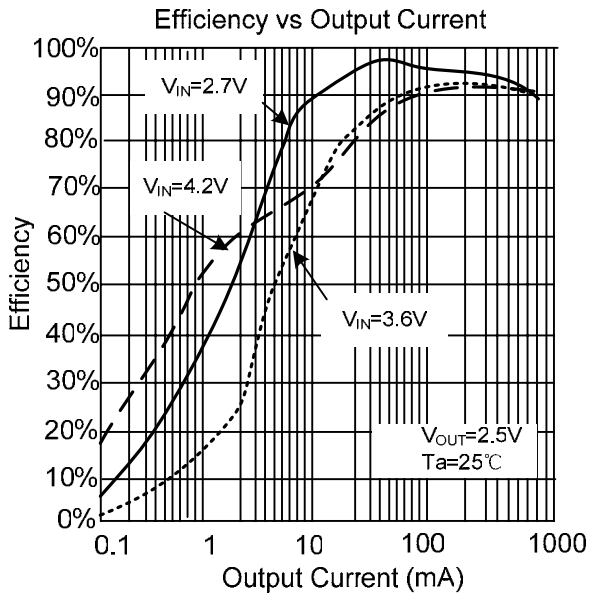

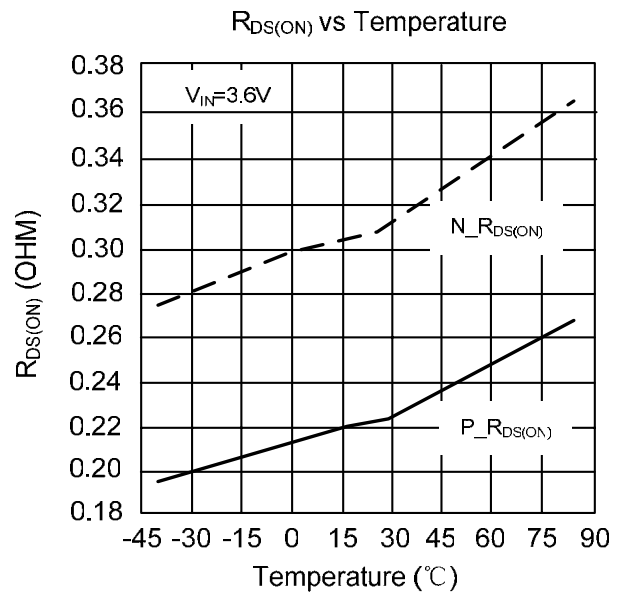
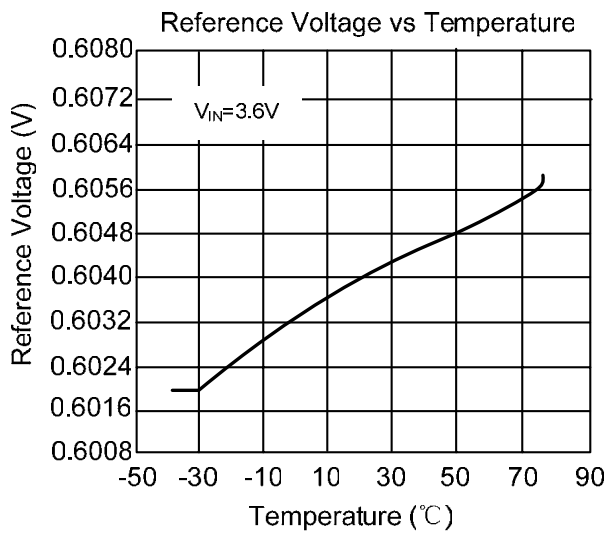
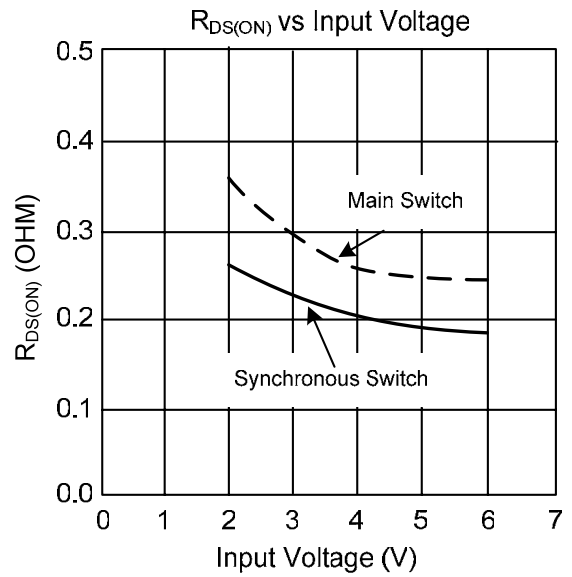
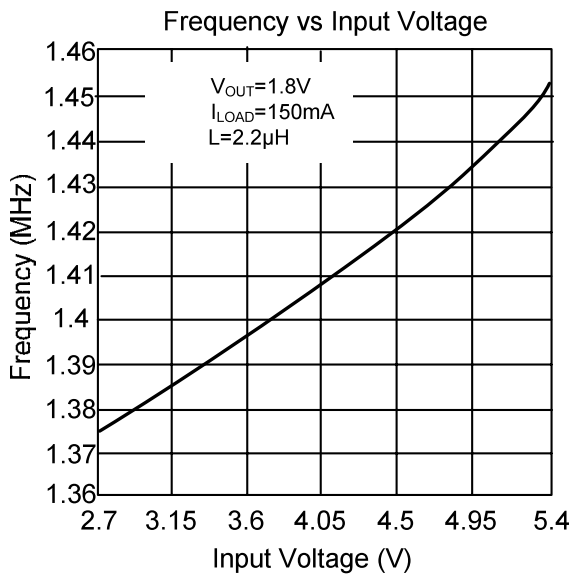
**Typical Performance Characteristics (Continued)**

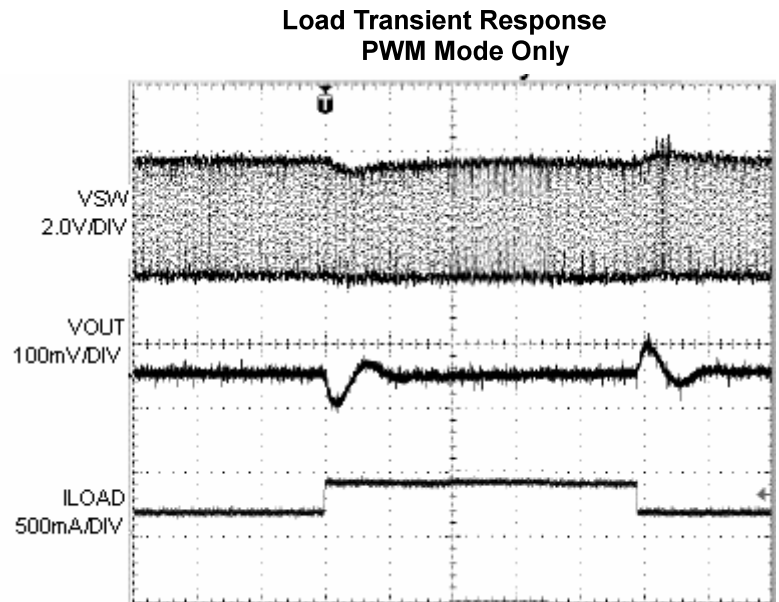
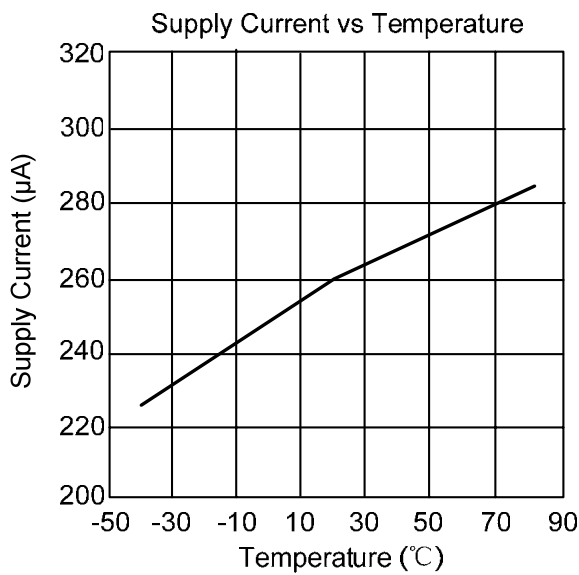
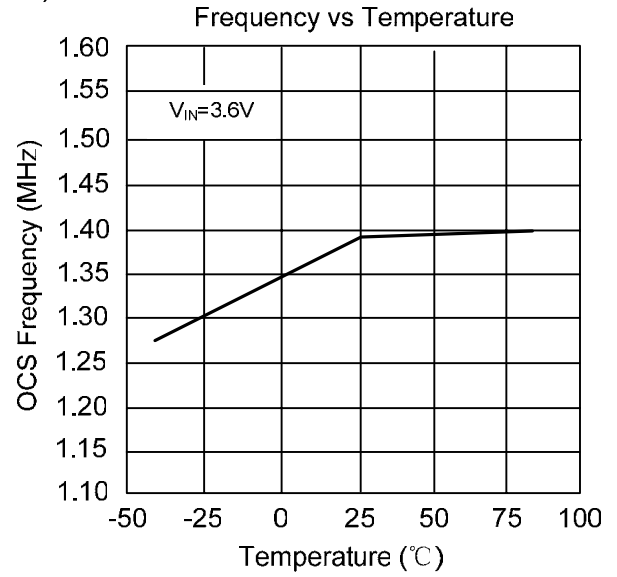
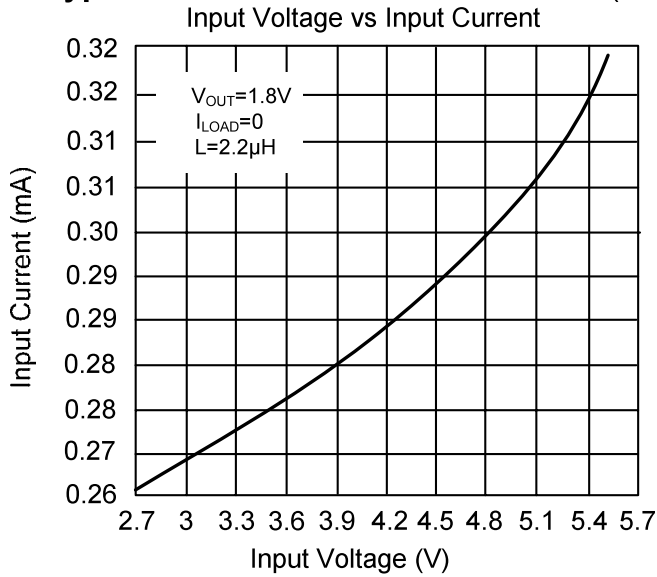
**Typical Performance Characteristics (Continued)**

$I_{LOAD}=100mA$  to  $400mA$   
 $L=2.2\mu H$ ,  $C_{in}=10\mu F$ ,  $C_{out}=10\mu F$ ,  $V_{in}=3.6V$ ,  $V_{out}=1.8V$

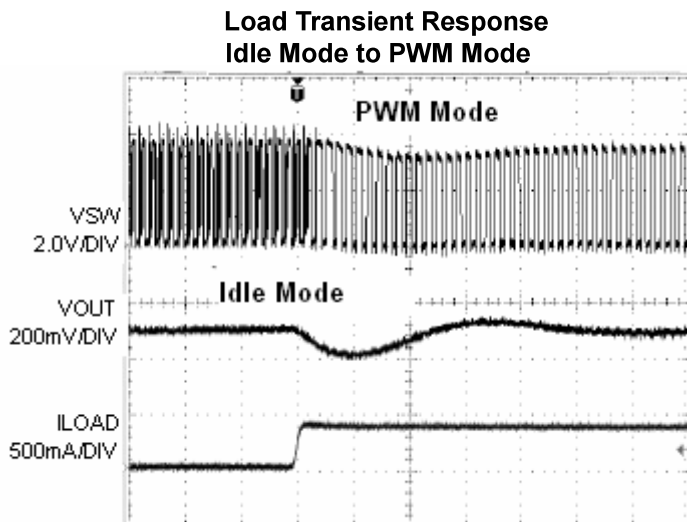

$I_{load}=28mA$  to  $400mA$ ,  $L=2.2\mu H$ ,  $C_{in}=10\mu F$ ,  $C_{out}=10\mu F$ ,  $V_{in}=3.6V$ ,  $V_{out}=1.8V$

## ■ Operation

AM2406 is a monolithic switching mode Step-Down DC-DC converter. It utilizes internal MOSFETs to achieve high efficiency and can generate very low output voltage by using internal reference at 0.6V. It operates at a fixed switching frequency, and uses the slope compensated current mode architecture. This Step-Down DC-DC Converter supplies 600mA output current at  $V_{IN}=3V$  with input voltage range from 2.5V to 5.5V.

## ■ Current Mode PWM Control

Slope compensated current mode PWM control provides stable switching and cycle-by-cycle current limit for excellent load and line responses and protection of the internal main switch (P-Ch MOSFET) and synchronous rectifier (N-Ch MOSFET). During normal operation, the internal P-Ch MOSFET is turned on for a certain time to ramp the inductor current at each rising edge of the internal oscillator, and switched off when the peak inductor current is above the error voltage. The current comparator,  $I_{COMP}$ , limits the peak inductor current. When the main switch is off, the synchronous rectifier will be turned on immediately and stay on until either the inductor current starts to reverse, as indicated by the current reversal comparator,  $I_{ZERO}$ , or the beginning of the next clock cycle. The OVDET comparator controls output transient overshoots by turning the main switch off and keeping it off until the fault is no longer present.

## ■ Idle Mode Operation

At very light loads, the AM2406 automatically enters Idle Mode. In the Idle mode, the inductor current may reach zero or reverse on each pulse. The PWM control loop will automatically skip pulses to maintain output regulation. The bottom MOSFET is turned off by the current reversal comparator,  $I_{ZERO}$ , and the switch voltage will ring. This is discontinuous mode operation, and is normal behavior for the switching regulator.

## ■ Dropout Operation

When the input voltage decreases toward the value of the output voltage, the AM2406 allows the main switch to remain on for more than one switching cycle and increases the duty cycle until it reaches 100%.

The duty cycle  $D$  of a step-down converter is defined as:

$$D = T_{ON} \times f_{OSC} \times 100\% \approx \frac{V_{OUT}}{V_{IN}} \times 100\%$$

Where  $T_{ON}$  is the main switch on time and  $f_{OSC}$  is the oscillator frequency (1.5MHz).

The output voltage then is the input voltage minus the voltage drop across the main switch and the inductor. At low input supply voltage, the  $R_{DS(ON)}$  of the P-Channel MOSFET increases, and the efficiency of the converter decreases. Caution must be exercised to ensure the heat dissipated not to exceed the maximum junction temperature of the IC.

## ■ Maximum Load Current

The AM2406 will operate with input supply voltages as low as 2.5V, however, the maximum load current decreases at lower input due to large IR drop on the main switch and synchronous rectifier. The slope compensation signal reduces the peak inductor current as a function of the duty cycle to prevent sub harmonic oscillations at duty cycles greater than 50%. Conversely the current limit increases as the duty cycle decreases.



**Application Information**

**Fig.1 Basic Application Circuit with AM2406 adjustable version**

**Fig.2 Basic Application Circuit with fixed output versions**
**Setting the Output Voltage**

Figure 1 above shows the basic application circuit with AM2406 adjustable output version. The external resistor sets the output voltage according to the following equation:

$$V_{OUT} = 0.6V \left( 1 + \frac{R2}{R1} \right)$$

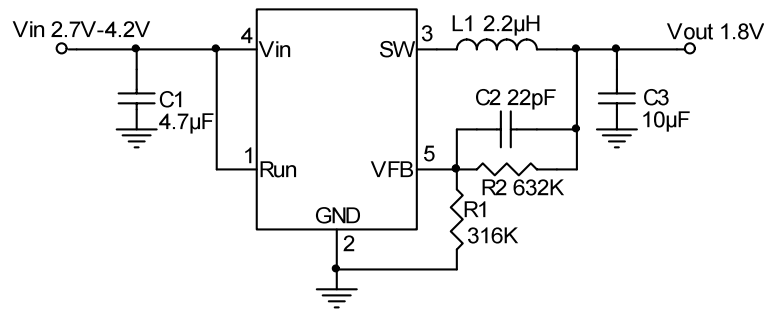
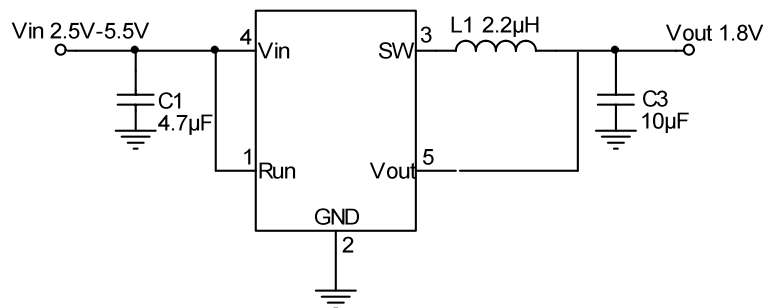
R1=300kΩ for all outputs; R2=300kΩ for  $V_{OUT}=1.2V$ , R2=200kΩ for  $V_{OUT}=1.5V$ , R2=150kΩ for  $V_{OUT}=1.8V$  and R=95.3kΩ for  $V_{OUT}=2.5V$ .

**Inductor Selection**

For most designs, the AM2406 operates with inductors of 1µH to 4.7µH. Low inductance values are physically smaller but require faster switching, which results in some efficiency loss. The inductor value can be derived from the following equation:

$$L = \frac{V_{OUT} \times (V_{IN} - V_{OUT})}{V_{IN} \times \Delta I_L \times f_{OSC}}$$

Where  $\Delta I_L$  is inductor Ripple Current. Large value inductors lower ripple current and small value inductors result in high ripple currents. Choose inductor ripple current approximately 35% of the maximum load current 600mA, or  $\Delta I_L=210mA$ .

For output voltages above 2.0V, when light-load efficiency is important, the minimum recommended inductor is 2.2µH. For optimum voltage-positioning load transients, choose an inductor with DC series resistance in the 50mΩ to 150mΩ range. For higher efficiency at heavy loads (above 200mA), or minimal load regulation (but some transient overshoot), the resistance should be kept below 100mΩ. The DC current rating of the inductor should be at least equal to the maximum load current plus half the ripple current to prevent core saturation (600mA+105mA). Table 1 lists some typical surface mount inductors that meet target applications for the AM2406

Part #	L (μH)	Max DCR (mΩ)	Rated D.C. Current (A)	Size W×L×H (mm)
Sumida CR43	14	56.2	2.52	4.5×4.0×3.5
	2.2	71.2	1.75	
	3.3	86.2	1.44	
	4.7	108.7	1.15	
Sumida CDRH4D18	1.5	75	1.32	4.7×4.7×2.0
	2.2			
	3.3			
	4.7			
Toko D312C	1.5	120	1.29	3.6×3.6×1.2
	2.2	140	1.14	
	3.3	180	0.98	
	4.7	240	0.79	

### Input Capacitor Selection

The input capacitor reduces the surge current drawn from the input and switching noise from the device. The input capacitor impedance at the switching frequency shall be less than input source impedance to prevent high frequency switching current passing to the input. A low ESR input capacitor sized for minimum RMS current must be used. Ceramic capacitors with X5R or X7R dielectrics are highly recommended because of their low ESR and small temperature coefficients. A 4.7μF ceramic capacitor for most applications is sufficient.

### Output Capacitor Selection

The output capacitor is requires to keep the output voltage ripple small and to ensure regulation loop stability. The output capacitor must have low impedance at the switching frequency. Ceramic capacitors with X5R or X7R dielectrics are recommended due to their low ESR and high ripple current. The output ripple  $V_{OUT}$  is determined by:

$$\Delta V_{OUT} \leq \frac{V_{OUT} \times (V_{IN} - V_{OUT})}{V_{IN} \times f_{OSC} \times L} \times \left( ESR + \frac{1}{8 \times f_{OSC} \times C3} \right)$$

### Ordering Information

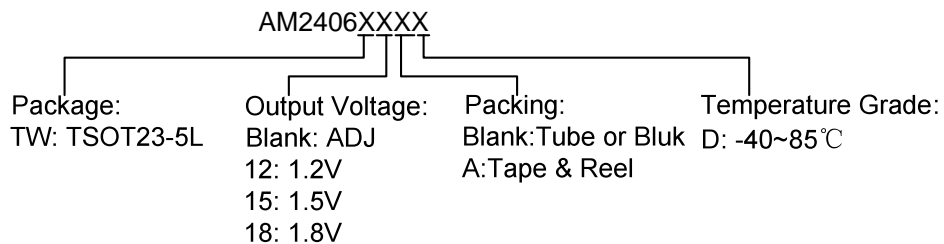

### Marking Information

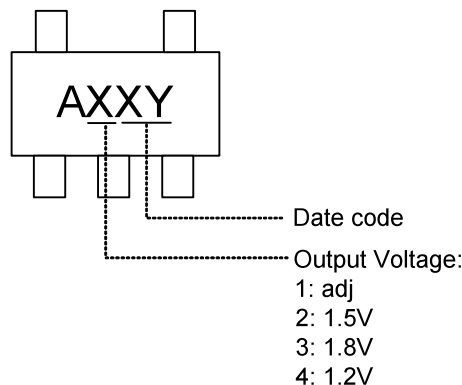

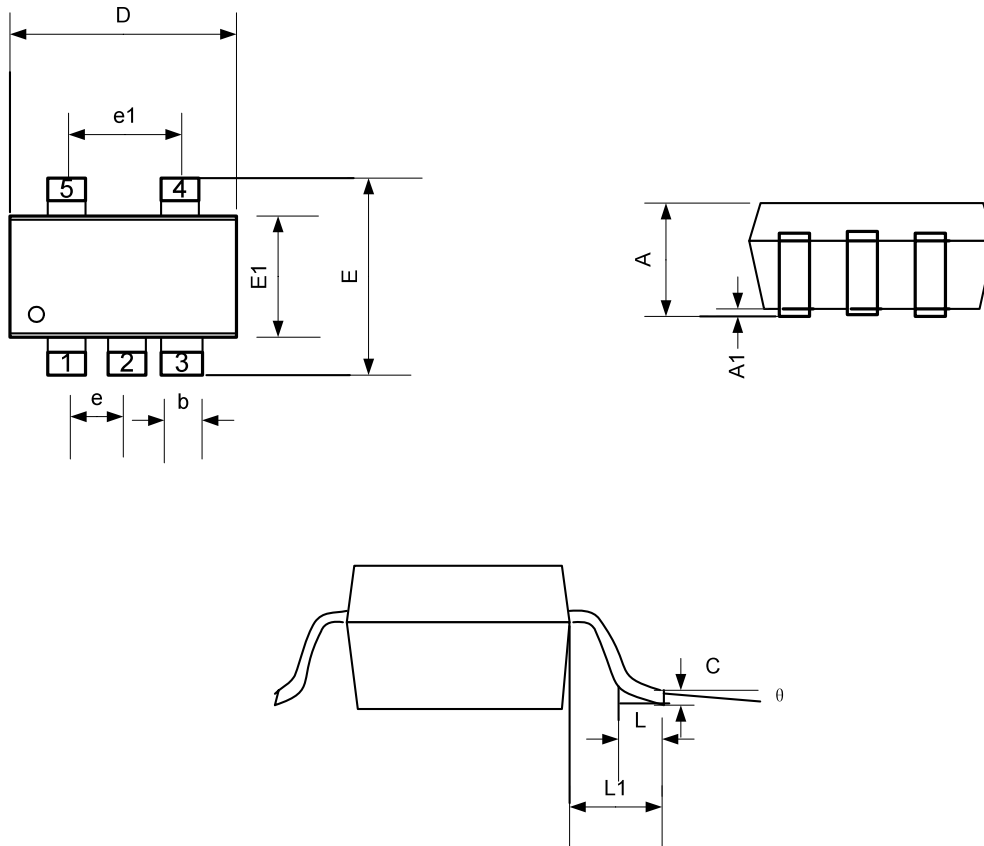
**Package Information**

Symbol	Dimensions In Millimeters		Dimensions In Inches	
	Min.	Max.	Min.	Max.
A	0.90	1.10	0.036	0.044
A1	0.01	0.13	0.0004	0.0052
b	0.30	0.50	0.012	0.020
C	0.09	0.20	0.0036	0.008
D	2.80	3.00	0.112	0.120
E	2.50	3.10	0.100	0.124
E1	1.50	1.70	0.060	0.068
L	0.20	0.55	0.008	0.022
L1	0.35	0.80	0.014	0.032
e	0.95 Bsc.		0.038 Bsc.	
e1	1.90 Bsc.		0.076 Bsc.	
$\theta$	0°	10°	0°	10°