

# MUN5111DW1T1G Series, SMUN5111DW1T1G Series

## Dual Bias Resistor Transistors

### PNP Silicon Surface Mount Transistors with Monolithic Bias Resistor Network

The Bias Resistor Transistor (BRT) contains a single transistor with a monolithic bias network consisting of two resistors; a series base resistor and a base-emitter resistor. These digital transistors are designed to replace a single device and its external resistor bias network. The BRT eliminates these individual components by integrating them into a single device. In the MUN5111DW1T1G series, two BRT devices are housed in the SOT-363 package which is ideal for low-power surface mount applications where board space is at a premium.

#### Features

- Simplifies Circuit Design
- Reduces Board Space
- Reduces Component Count
- S Prefix for Automotive and Other Applications Requiring Unique Site and Control Change Requirements; AEC-Q101 Qualified and PPAP Capable
- These Devices are Pb-Free, Halogen Free/BFR Free and are RoHS Compliant\*

#### MAXIMUM RATINGS

( $T_A = 25^\circ\text{C}$  unless otherwise noted, common for  $Q_1$  and  $Q_2$ )

Rating	Symbol	Value	Unit
Collector-Base Voltage	$V_{CBO}$	-50	Vdc
Collector-Emitter Voltage	$V_{CEO}$	-50	Vdc
Collector Current	$I_C$	-100	mAdc

Stresses exceeding Maximum Ratings may damage the device. Maximum Ratings are stress ratings only. Functional operation above the Recommended Operating Conditions is not implied. Extended exposure to stresses above the Recommended Operating Conditions may affect device reliability.



ON Semiconductor®

<http://onsemi.com>



SC-88 / SOT-363  
CASE 419B  
STYLE 1

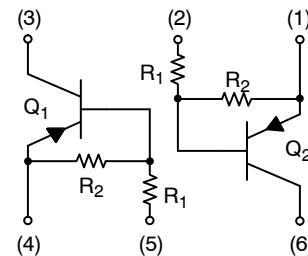

#### MARKING DIAGRAM

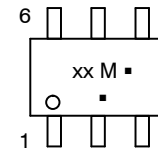

- xx = Device Code (Refer to page 2)
- M = Date Code
- = Pb-Free Package

(Note: Microdot may be in either location)

#### ORDERING INFORMATION

See detailed ordering and shipping information in the table on page 2 of this data sheet.

#### DEVICE MARKING INFORMATION

See specific marking information in the device marking table on page 2 of this data sheet.

\*For additional information on our Pb-Free strategy and soldering details, please download the ON Semiconductor Soldering and Mounting Techniques Reference Manual, SOLDERRM/D.

## MUN5111DW1T1G Series, SMUN5111DW1T1G Series

### THERMAL CHARACTERISTICS

Characteristic (One Junction Heated)	Symbol	Max	Unit
Total Device Dissipation $T_A = 25^\circ\text{C}$ Derate above $25^\circ\text{C}$	$P_D$	187 (Note 1) 256 (Note 2) 1.5 (Note 1) 2.0 (Note 2)	mW mW/ $^\circ\text{C}$
Thermal Resistance, Junction-to-Ambient	$R_{\theta JA}$	670 (Note 1) 490 (Note 2)	$^\circ\text{C}/\text{W}$
Characteristic (Both Junctions Heated)	Symbol	Max	Unit
Total Device Dissipation $T_A = 25^\circ\text{C}$ Derate above $25^\circ\text{C}$	$P_D$	250 (Note 1) 385 (Note 2) 2.0 (Note 1) 3.0 (Note 2)	mW mW/ $^\circ\text{C}$
Thermal Resistance, Junction-to-Ambient	$R_{\theta JA}$	493 (Note 1) 325 (Note 2)	$^\circ\text{C}/\text{W}$
Thermal Resistance, Junction-to-Lead	$R_{\theta JL}$	188 (Note 1) 208 (Note 2)	$^\circ\text{C}/\text{W}$
Junction and Storage Temperature Range	$T_J, T_{stg}$	-55 to +150	$^\circ\text{C}$

1. FR-4 @ Minimum Pad
2. FR-4 @ 1.0 x 1.0 inch Pad

### ORDERING INFORMATION, DEVICE MARKINGS AND RESISTOR VALUES

Device	Package	Marking	R1 (K)	R2 (K)	Shipping <sup>†</sup>
MUN5111DW1T1G, SMUN5111DW1T1G	SOT-363 (Pb-Free)	0A	10	10	3,000/Tape & Reel
MUN5112DW1T1G, SMUN5112DW1T1G	SOT-363 (Pb-Free)	0B	22	22	3,000/Tape & Reel
MUN5113DW1T1G, SMUN5113DW1T1G	SOT-363 (Pb-Free)	0C	47	47	3,000/Tape & Reel
MUN5114DW1T1G, SMUN5114DW1T1G	SOT-363 (Pb-Free)	0D	10	47	3,000/Tape & Reel
MUN5115DW1T1G, SMUN5115DW1T1G	SOT-363 (Pb-Free)	0E	10	$\infty$	3,000/Tape & Reel
MUN5116DW1T1G, SMUN5116DW1T1G	SOT-363 (Pb-Free)	0F	4.7	$\infty$	3,000/Tape & Reel
MUN5130DW1T1G	SOT-363 (Pb-Free)	0G	1.0	1.0	3,000/Tape & Reel
MUN5131DW1T1G, SMUN5131DW1T1G	SOT-363 (Pb-Free)	0H	2.2	2.2	3,000/Tape & Reel
MUN5132DW1T1G	SOT-363 (Pb-Free)	0J	4.7	4.7	3,000/Tape & Reel
MUN5133DW1T1G	SOT-363 (Pb-Free)	0K	4.7	47	3,000/Tape & Reel
MUN5134DW1T1G	SOT-363 (Pb-Free)	0L	22	47	3,000/Tape & Reel
MUN5135DW1T1G	SOT-363 (Pb-Free)	0M	2.2	47	3,000/Tape & Reel
MUN5136DW1T1G	SOT-363 (Pb-Free)	0N	100	100	3,000/Tape & Reel
MUN5137DW1T1G	SOT-363 (Pb-Free)	0P	47	22	3,000/Tape & Reel

<sup>†</sup>For information on tape and reel specifications, including part orientation and tape sizes, please refer to our Tape and Reel Packaging Specifications Brochure, BRD8011/D.

# MUN5111DW1T1G Series, SMUN5111DW1T1G Series

## ELECTRICAL CHARACTERISTICS (T<sub>A</sub> = 25°C unless otherwise noted, common for Q<sub>1</sub> and Q<sub>2</sub>)

Characteristic	Symbol	Min	Typ	Max	Unit
<b>OFF CHARACTERISTICS</b>					
Collector-Base Cutoff Current (V <sub>CB</sub> = -50 V, I <sub>E</sub> = 0)	I <sub>CBO</sub>	-	-	-100	nAdc
Collector-Emitter Cutoff Current (V <sub>CE</sub> = -50 V, I <sub>B</sub> = 0)	I <sub>CEO</sub>	-	-	-500	nAdc
Emitter-Base Cutoff Current (V <sub>EB</sub> = -6.0 V, I <sub>C</sub> = 0)	I <sub>EBO</sub>				mAdc
MUN5111DW1T1G, SMUN5111DW1T1G		-	-	-0.5	
MUN5112DW1T1G, SMUN5112DW1T1G		-	-	-0.2	
MUN5113DW1T1G, SMUN5113DW1T1G		-	-	-0.1	
MUN5114DW1T1G, SMUN5114DW1T1G		-	-	-0.2	
MUN5115DW1T1G, SMUN5115DW1T1G		-	-	-0.9	
MUN5116DW1T1G, SMUN5116DW1T1G		-	-	-1.9	
MUN5130DW1T1G		-	-	-4.3	
MUN5131DW1T1G, SMUN5131DW1T1G		-	-	-2.3	
MUN5132DW1T1G		-	-	-1.5	
MUN5133DW1T1G		-	-	-0.18	
MUN5134DW1T1G		-	-	-0.13	
MUN5135DW1T1G		-	-	-0.2	
MUN5136DW1T1G		-	-	-0.05	
MUN5137DW1T1G		-	-	-0.13	
Collector-Base Breakdown Voltage (I <sub>C</sub> = -10 μA, I <sub>E</sub> = 0)	V <sub>(BR)CBO</sub>	-50	-	-	Vdc
Collector-Emitter Breakdown Voltage (Note 3) (I <sub>C</sub> = -2.0 mA, I <sub>B</sub> = 0)	V <sub>(BR)CEO</sub>	-50	-	-	Vdc

## ON CHARACTERISTICS (Note 3)

Collector-Emitter Saturation Voltage (I <sub>C</sub> = -10 mA, I <sub>B</sub> = -0.3 mA)	V <sub>CE(sat)</sub>				Vdc
MUN5111DW1T1G, SMUN5111DW1T1G		-	-	-0.25	
MUN5112DW1T1G, SMUN5112DW1T1G		-	-	-0.25	
MUN5113DW1T1G, SMUN5113DW1T1G		-	-	-0.25	
MUN5114DW1T1G, SMUN5114DW1T1G		-	-	-0.25	
MUN5135DW1T1G		-	-	-0.25	
MUN5136DW1T1G		-	-	-0.25	
(I <sub>C</sub> = -10 mA, I <sub>B</sub> = -5 mA)					
MUN5130DW1T1G		-	-	-0.25	
MUN5131DW1T1G, SMUN5131DW1T1G		-	-	-0.25	
MUN5137DW1T1G		-	-	-0.25	
(I <sub>C</sub> = -10 mA, I <sub>B</sub> = -1 mA)					
MUN5115DW1T1G, SMUN5115DW1T1G		-	-	-0.25	
MUN5116DW1T1G, SMUN5116DW1T1G		-	-	-0.25	
MUN5132DW1T1G		-	-	-0.25	
MUN5133DW1T1G		-	-	-0.25	
MUN5134DW1T1G		-	-	-0.25	
DC Current Gain (V <sub>CE</sub> = -10 V, I <sub>C</sub> = -5.0 mA)	h <sub>FE</sub>				
MUN5111DW1T1G, SMUN5111DW1T1G		35	60	-	
MUN5112DW1T1G, SMUN5112DW1T1G		60	100	-	
MUN5113DW1T1G, SMUN5113DW1T1G		80	140	-	
MUN5114DW1T1G, SMUN5114DW1T1G		80	140	-	
MUN5115DW1T1G, SMUN5115DW1T1G		160	250	-	
MUN5116DW1T1G, SMUN5116DW1T1G		160	250	-	
MUN5130DW1T1G		3.0	5.0	-	
MUN5131DW1T1G, SMUN5131DW1T1G		8.0	15	-	
MUN5132DW1T1G		15	27	-	
MUN5133DW1T1G		80	140	-	
MUN5134DW1T1G		80	130	-	
MUN5135DW1T1G		80	140	-	
MUN5136DW1T1G		80	130	-	
MUN5137DW1T1G		80	140	-	

3. Pulse Test: Pulse Width < 300 μs, Duty Cycle < 2.0%

# MUN5111DW1T1G Series, SMUN5111DW1T1G Series

## ELECTRICAL CHARACTERISTICS (T<sub>A</sub> = 25°C unless otherwise noted, common for Q<sub>1</sub> and Q<sub>2</sub>) (Continued)

Characteristic	Symbol	Min	Typ	Max	Unit
<b>ON CHARACTERISTICS</b> (Note 4) (Continued)					
Output Voltage (on) (V <sub>CC</sub> = -5.0 V, V <sub>B</sub> = -2.5 V, R <sub>L</sub> = 1.0 kΩ) MUN5111DW1T1G, SMUN5111DW1T1G MUN5112DW1T1G, SMUN5112DW1T1G MUN5114DW1T1G, SMUN5114DW1T1G MUN5115DW1T1G, SMUN5115DW1T1G MUN5116DW1T1G, SMUN5116DW1T1G MUN5130DW1T1G MUN5131DW1T1G, SMUN5131DW1T1G MUN5132DW1T1G MUN5133DW1T1G MUN5134DW1T1G MUN5135DW1T1G (V <sub>CC</sub> = -5.0 V, V <sub>B</sub> = -3.5 V, R <sub>L</sub> = 1.0 kΩ) MUN5113DW1T1G, SMUN5113DW1T1G (V <sub>CC</sub> = -5.0 V, V <sub>B</sub> = -5.5 V, R <sub>L</sub> = 1.0 kΩ) MUN5136DW1T1G (V <sub>CC</sub> = -5.0 V, V <sub>B</sub> = -4.0 V, R <sub>L</sub> = 1.0 kΩ) MUN5137DW1T1G	V <sub>OL</sub>	-	-	-0.2	Vdc
Output Voltage (off) (V <sub>CC</sub> = -5.0 V, V <sub>B</sub> = -0.5 V, R <sub>L</sub> = 1.0 kΩ) MUN5111DW1T1G, SMUN5111DW1T1G MUN5112DW1T1G, SMUN5112DW1T1G MUN5113DW1T1G, SMUN5113DW1T1G MUN5114DW1T1G, SMUN5114DW1T1G MUN5133DW1T1G MUN5134DW1T1G MUN5135DW1T1G MUN5136DW1T1G (V <sub>CC</sub> = -5.0 V, V <sub>B</sub> = -0.05 V, R <sub>L</sub> = 1.0 kΩ) MUN5130DW1T1G (V <sub>CC</sub> = -5.0 V, V <sub>B</sub> = -0.25 V, R <sub>L</sub> = 1.0 kΩ) MUN5115DW1T1G, SMUN5115DW1T1G MUN5116DW1T1G, SMUN5116DW1T1G MUN5131DW1T1G, SMUN5131DW1T1G MUN5132DW1T1G MUN5137DW1T1G	V <sub>OH</sub>	-4.9	-	-	Vdc
Input Resistor MUN5111DW1T1G, SMUN5111DW1T1G MUN5112DW1T1G, SMUN5112DW1T1G MUN5113DW1T1G, SMUN5113DW1T1G MUN5114DW1T1G, SMUN5114DW1T1G MUN5115DW1T1G, SMUN5115DW1T1G MUN5116DW1T1G, SMUN5116DW1T1G MUN5130DW1T1G MUN5131DW1T1G, SMUN5131DW1T1G MUN5132DW1T1G MUN5133DW1T1G MUN5134DW1T1G MUN5135DW1T1G MUN5136DW1T1G MUN5137DW1T1G	R <sub>1</sub>	7.0	10	13	k Ω
Resistor Ratio MUN5111DW1T1G, SMUN5111DW1T1G MUN5112DW1T1G, SMUN5112DW1T1G MUN5113DW1T1G, SMUN5113DW1T1G MUN5114DW1T1G, SMUN5114DW1T1G MUN5115DW1T1G, SMUN5115DW1T1G MUN5116DW1T1G, SMUN5116DW1T1G MUN5130DW1T1G MUN5131DW1T1G, SMUN5131DW1T1G MUN5132DW1T1G MUN5133DW1T1G MUN5134DW1T1G MUN5135DW1T1G MUN5136DW1T1G MUN5137DW1T1G	R <sub>1</sub> /R <sub>2</sub>	0.8	1.0	1.2	

4. Pulse Test: Pulse Width < 300 μs, Duty Cycle < 2.0%

# MUN5111DW1T1G Series, SMUN5111DW1T1G Series

## ALL MUN5111DW1T1G SERIES DEVICES

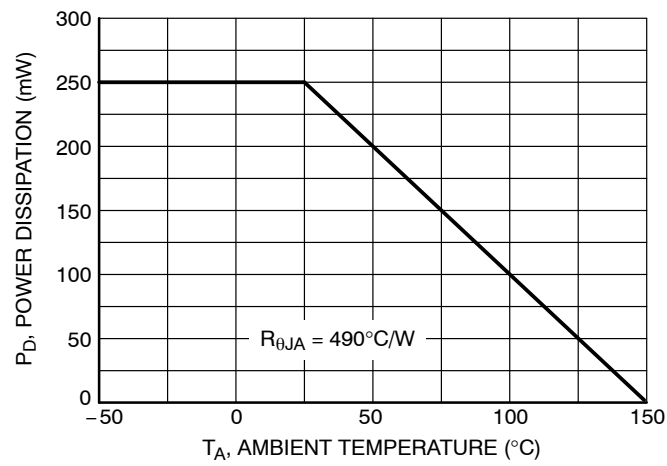

Figure 1. Derating Curve – ALL DEVICES

# MUN5111DW1T1G Series, SMUN5111DW1T1G Series

## TYPICAL ELECTRICAL CHARACTERISTICS — MUN5111DW1T1G, SMUN5111DW1T1G

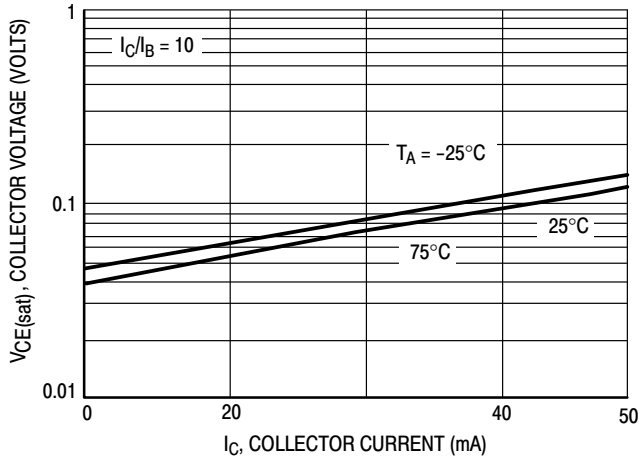

Figure 2.  $V_{CE(sat)}$  versus  $I_C$

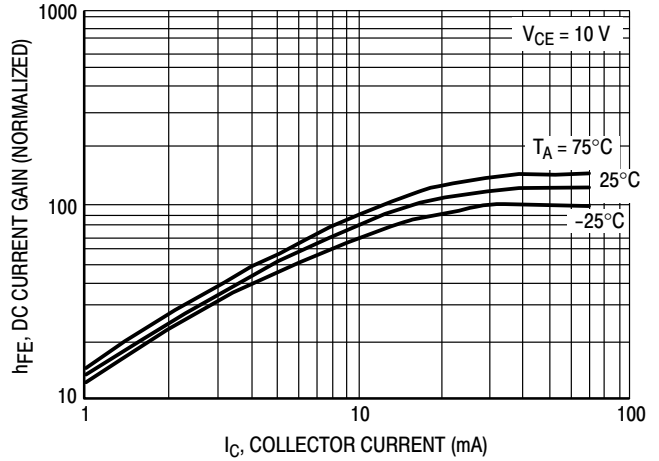

Figure 3. DC Current Gain

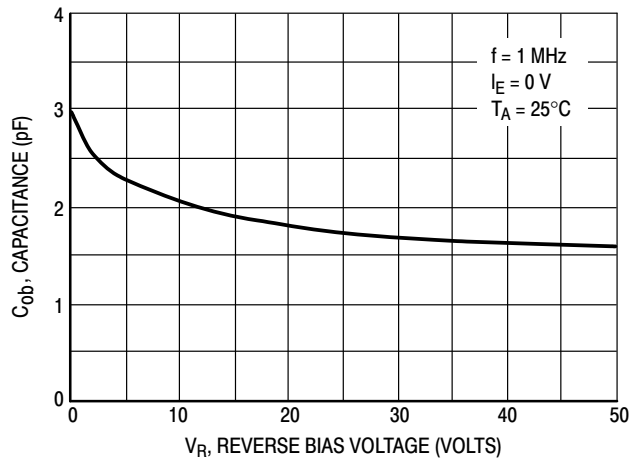

Figure 4. Output Capacitance

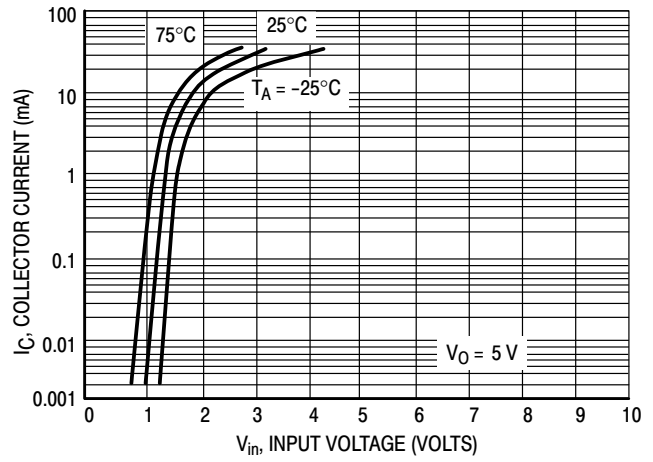

Figure 5. Output Current versus Input Voltage

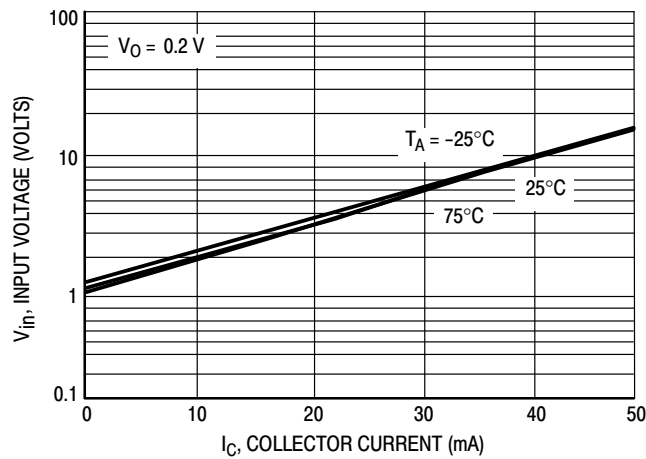

Figure 6. Input Voltage versus Output Current

# MUN5111DW1T1G Series, SMUN5111DW1T1G Series

## TYPICAL ELECTRICAL CHARACTERISTICS — MUN5112DW1T1G, SMUN5112DW1T1G

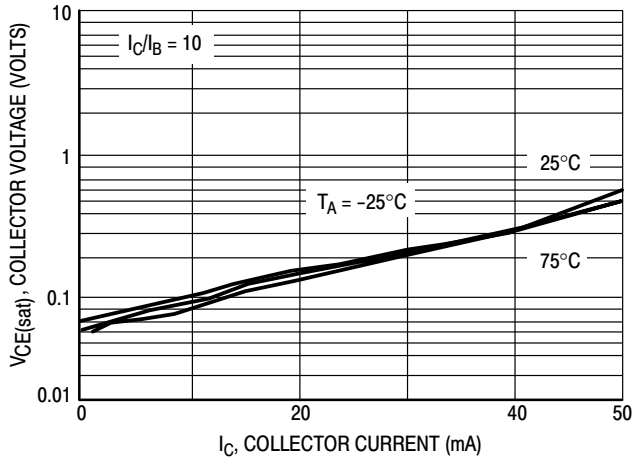

Figure 7.  $V_{CE(sat)}$  versus  $I_C$

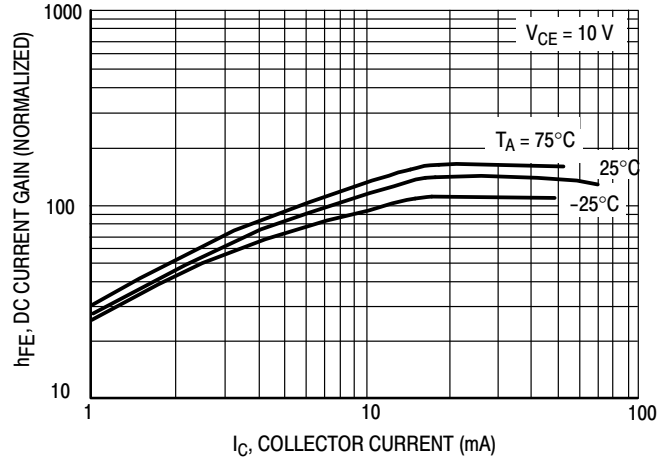

Figure 8. DC Current Gain

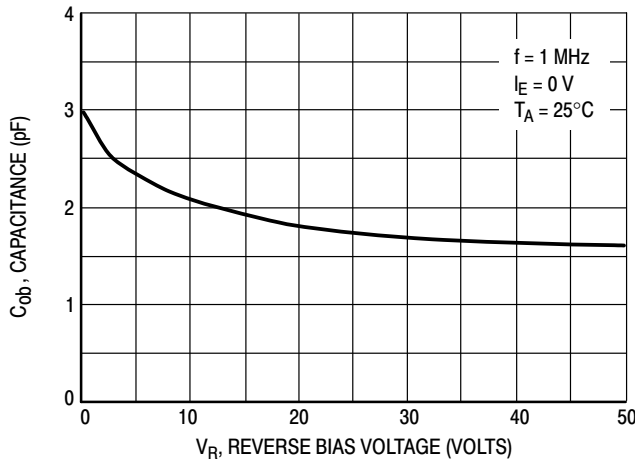

Figure 9. Output Capacitance

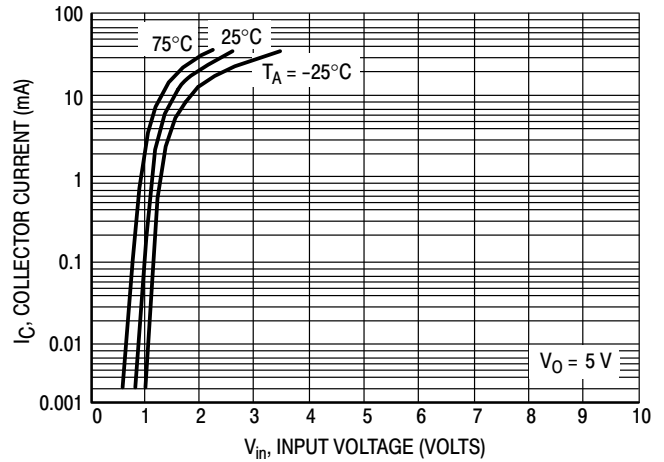

Figure 10. Output Current versus Input Voltage

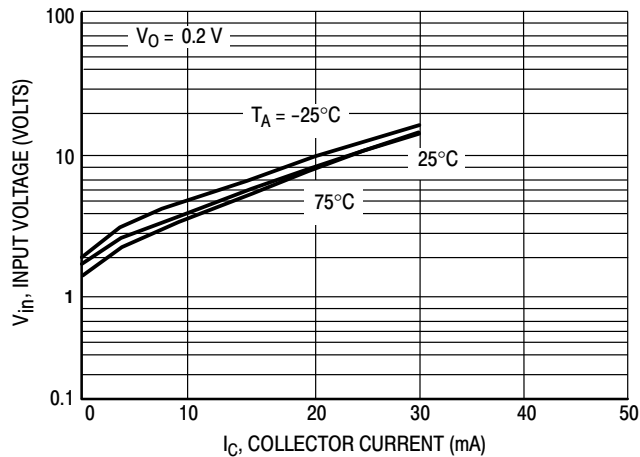

Figure 11. Input Voltage versus Output Current

# MUN5111DW1T1G Series, SMUN5111DW1T1G Series

## TYPICAL ELECTRICAL CHARACTERISTICS — MUN5113DW1T1G, SMUN5113DW1T1G

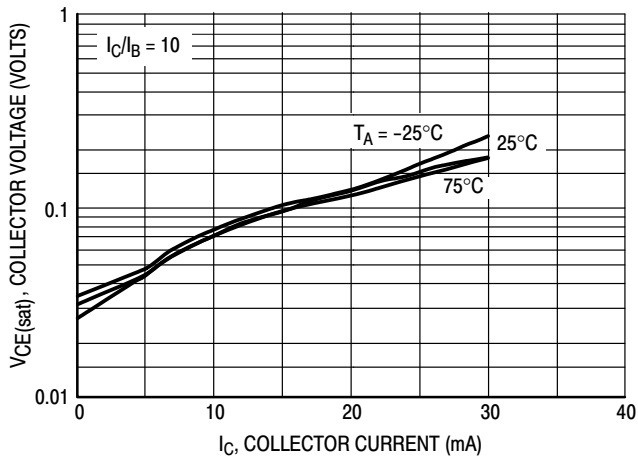

Figure 12.  $V_{CE(sat)}$  versus  $I_C$

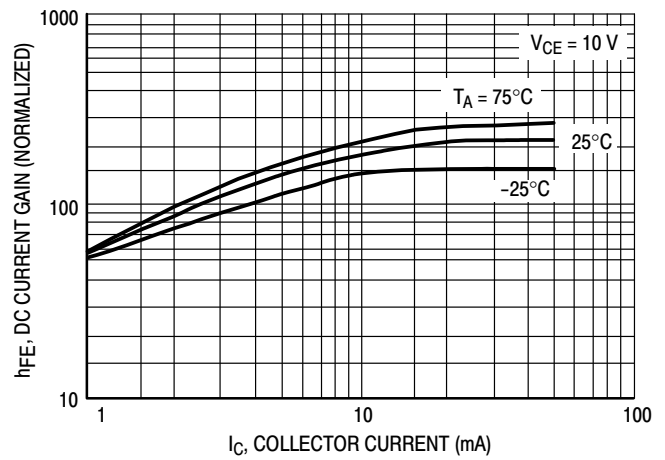

Figure 13. DC Current Gain

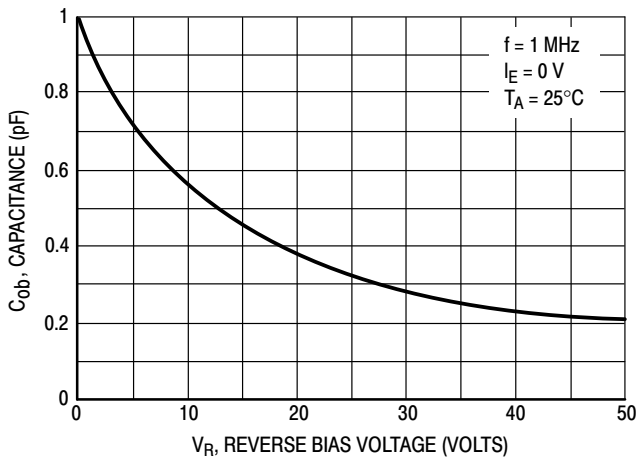

Figure 14. Output Capacitance

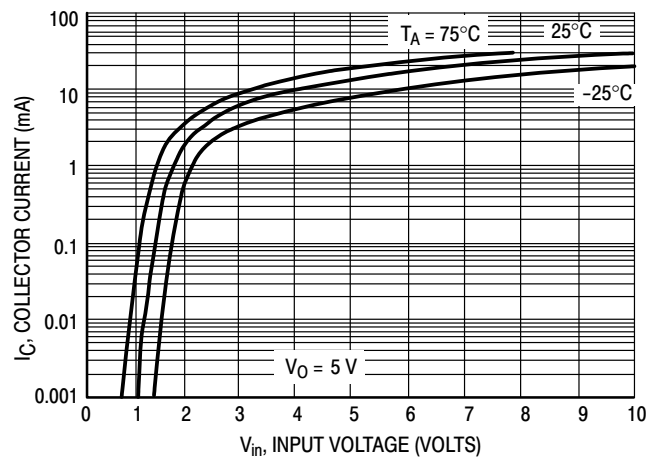

Figure 15. Output Current versus Input Voltage

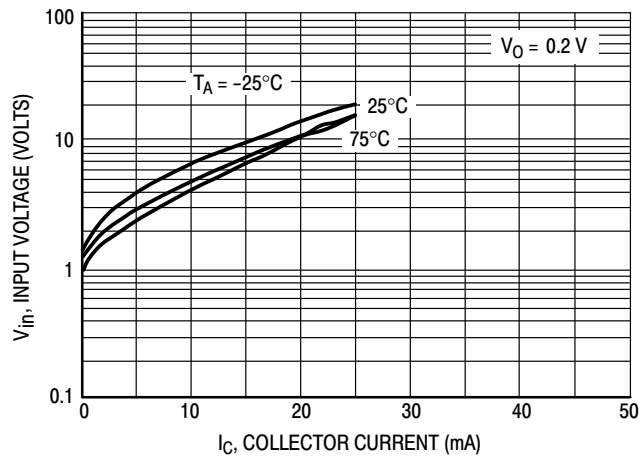

Figure 16. Input Voltage versus Output Current



MUN5111DW1T1G Series, SMUN5111DW1T1G Series

TYPICAL ELECTRICAL CHARACTERISTICS — MUN5114DW1T1G, SMUN5114DW1T1G

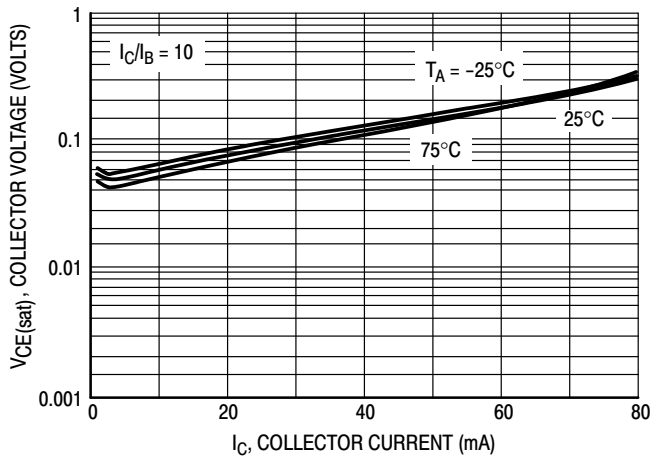

Figure 17.  $V_{CE(sat)}$  versus  $I_C$

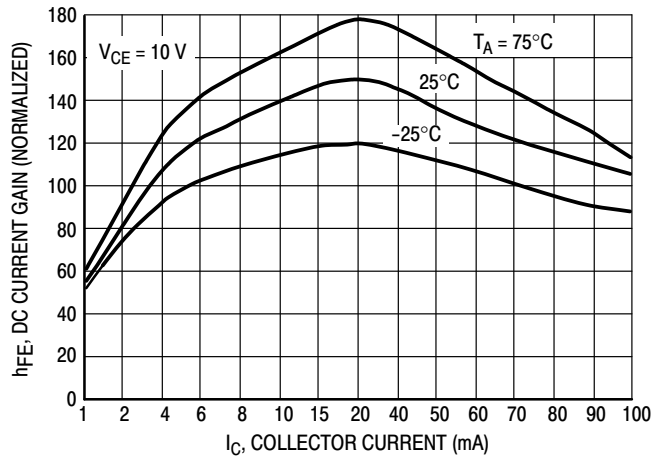

Figure 18. DC Current Gain

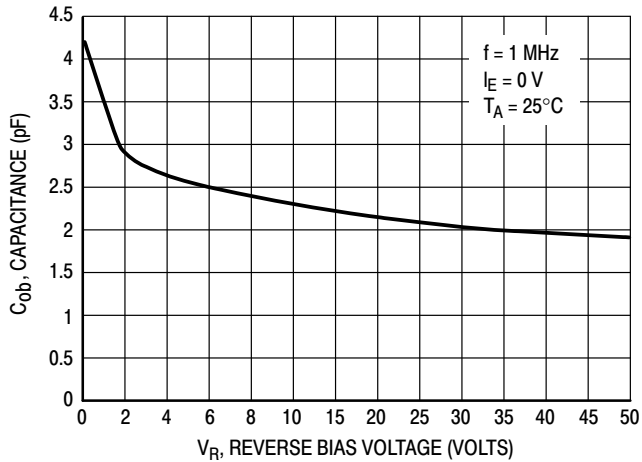

Figure 19. Output Capacitance

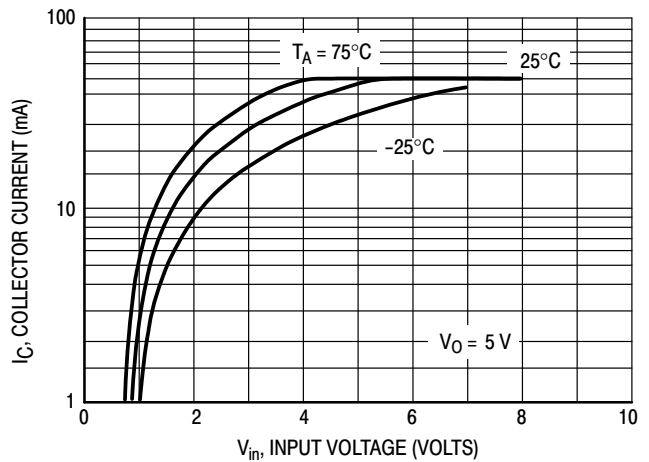

Figure 20. Output Current versus Input Voltage

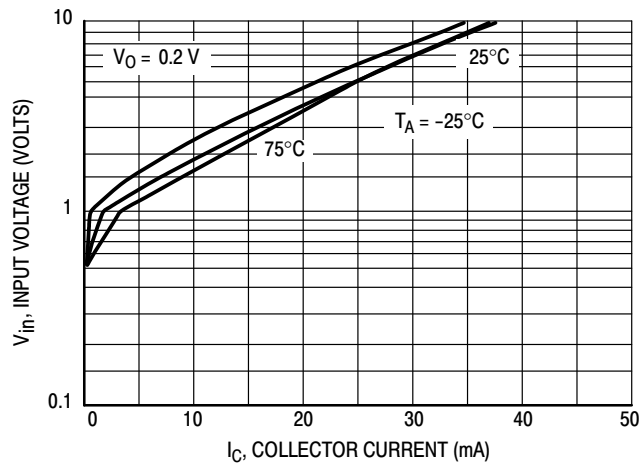

Figure 21. Input Voltage versus Output Current

# MUN5111DW1T1G Series, SMUN5111DW1T1G Series

## TYPICAL ELECTRICAL CHARACTERISTICS — MUN5115DW1T1G, SMUN5115DW1T1G

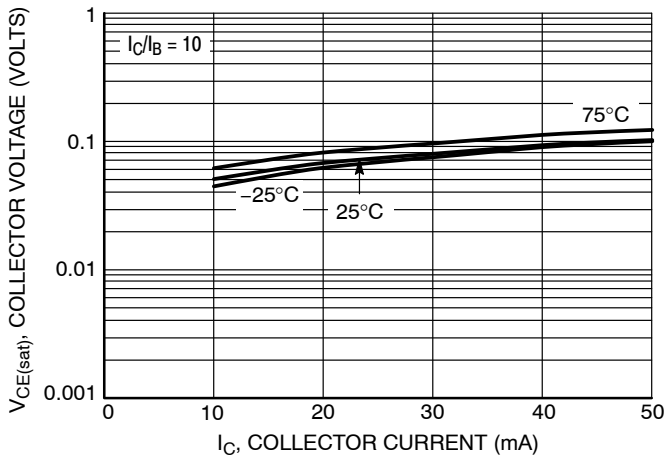

Figure 22.  $V_{CE(sat)}$  versus  $I_C$

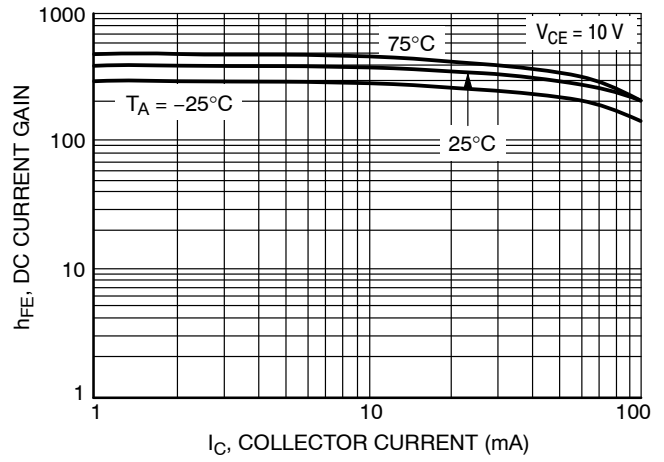

Figure 23. DC Current Gain

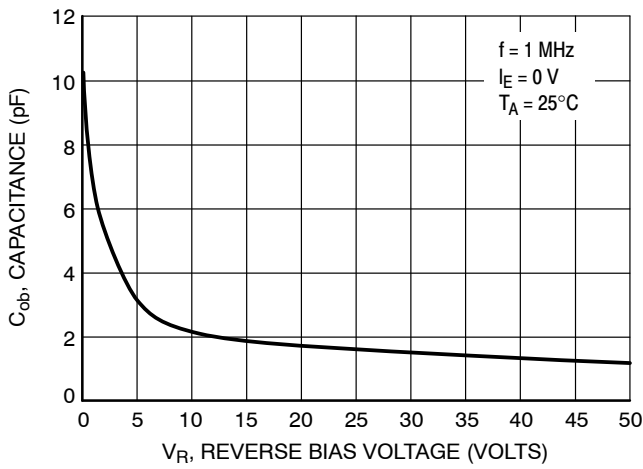

Figure 24. Output Capacitance

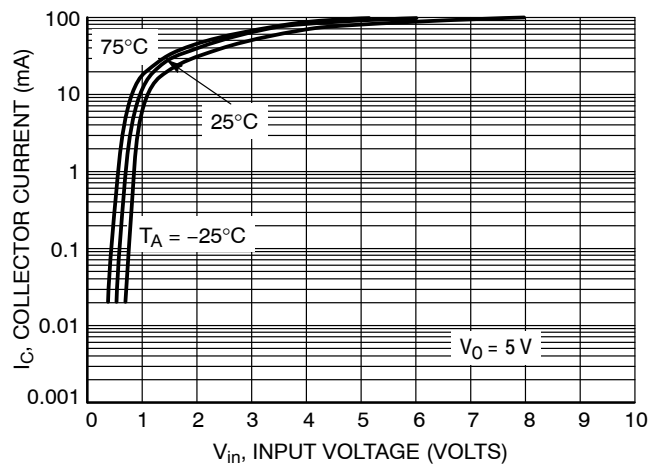

Figure 25. Output Current versus Input Voltage

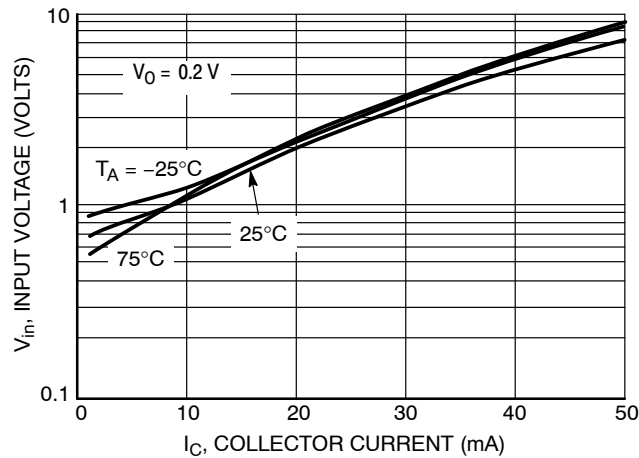

Figure 26. Input Voltage versus Output Current

# MUN5111DW1T1G Series, SMUN5111DW1T1G Series

## TYPICAL ELECTRICAL CHARACTERISTICS — MUN5116DW1T1G, SMUN5116DW1T1G

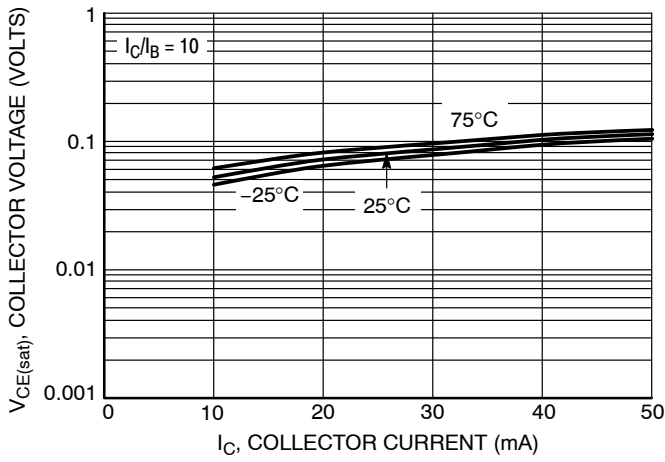

Figure 27.  $V_{CE(sat)}$  versus  $I_C$

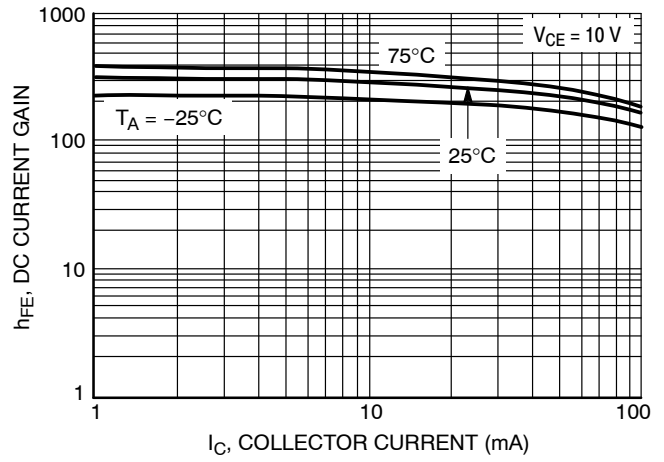

Figure 28. DC Current Gain

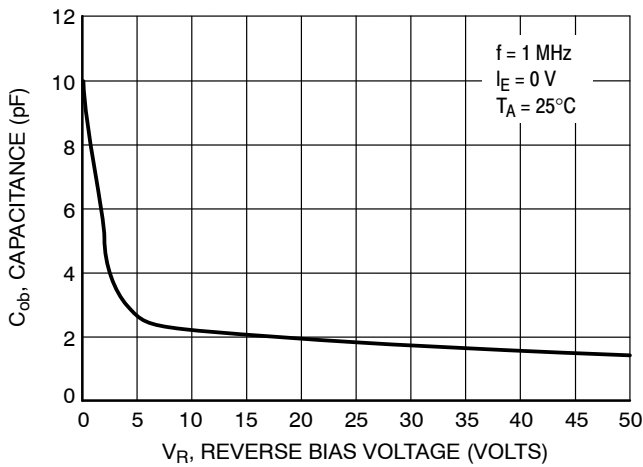

Figure 29. Output Capacitance

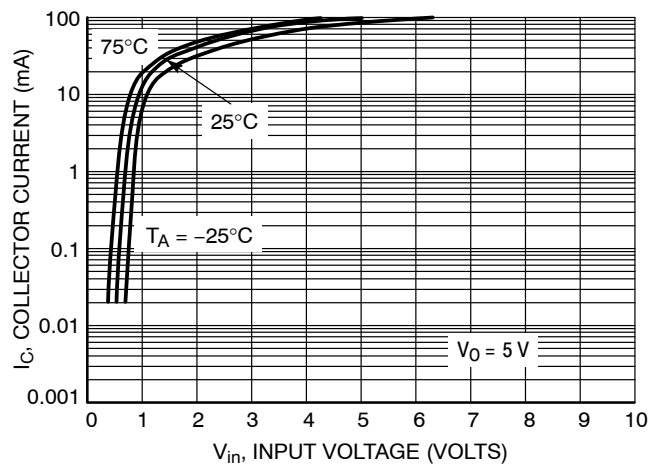

Figure 30. Output Current versus Input Voltage

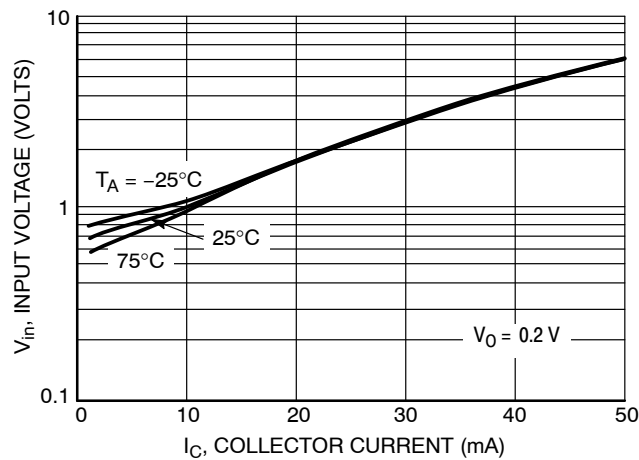

Figure 31. Input Voltage versus Output Current

MUN5111DW1T1G Series, SMUN5111DW1T1G Series

TYPICAL ELECTRICAL CHARACTERISTICS — MUN5130DW1T1G

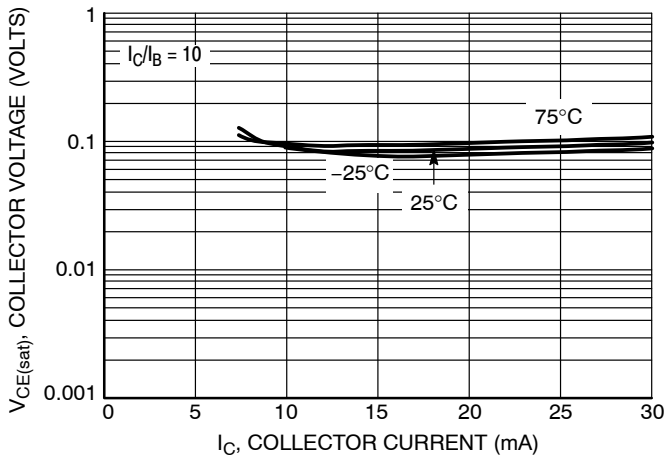

Figure 32.  $V_{CE(sat)}$  versus  $I_C$

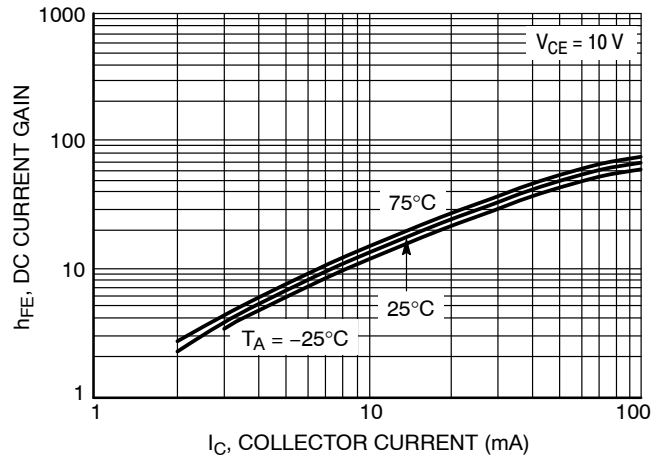

Figure 33. DC Current Gain

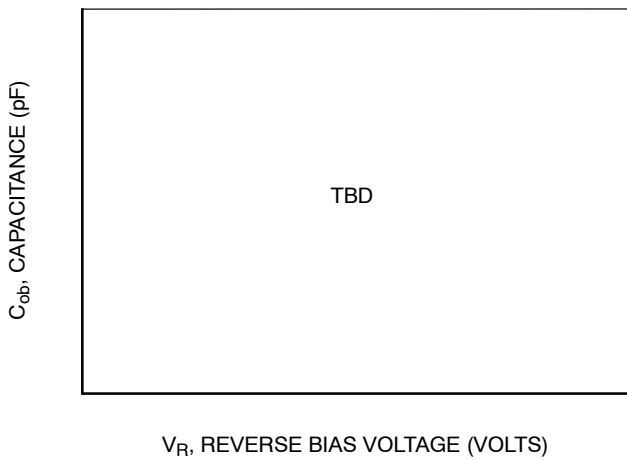

Figure 34. Output Capacitance

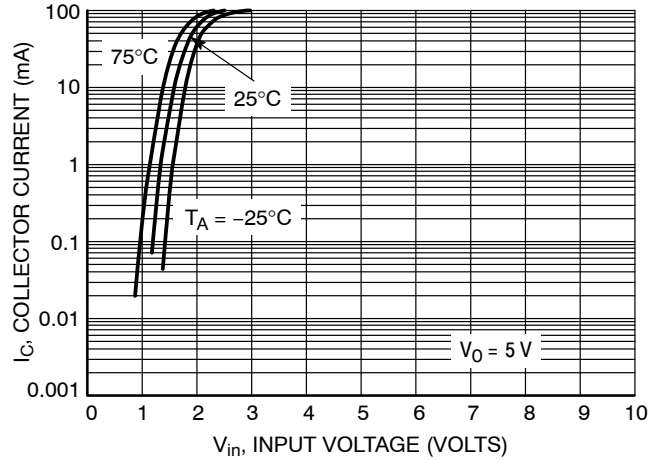

Figure 35. Output Current versus Input Voltage

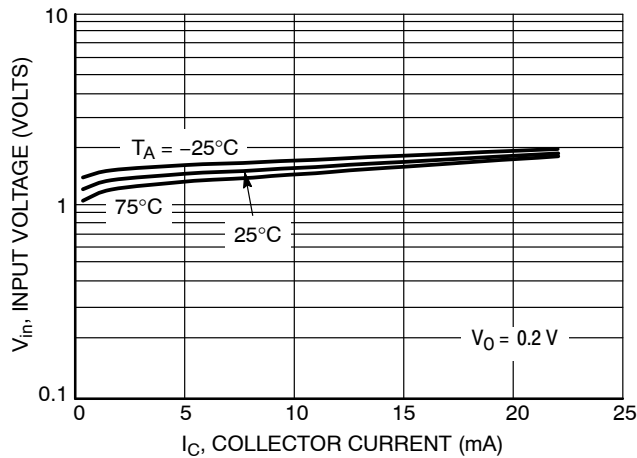

Figure 36. Input Voltage versus Output Current

# MUN5111DW1T1G Series, SMUN5111DW1T1G Series

## TYPICAL ELECTRICAL CHARACTERISTICS — MUN5131DW1T1G, SMUN5131DW1T1G

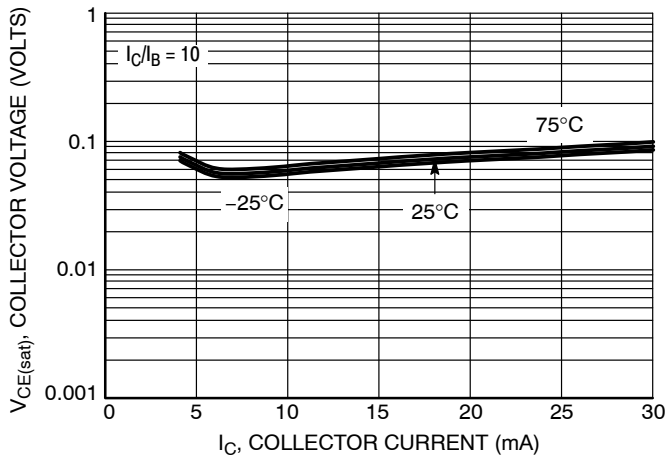

Figure 37.  $V_{CE(sat)}$  versus  $I_C$

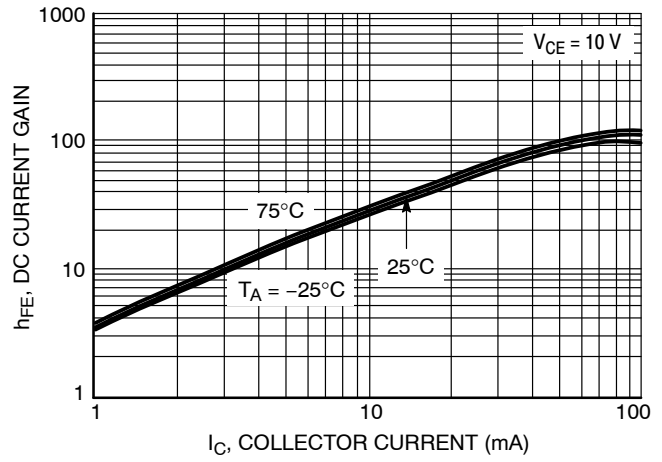

Figure 38. DC Current Gain

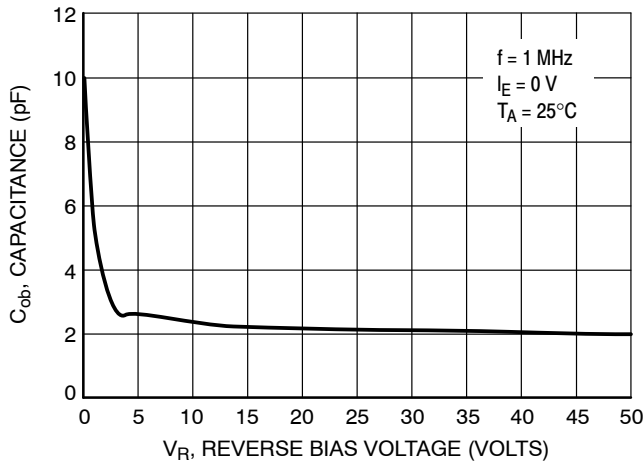

Figure 39. Output Capacitance

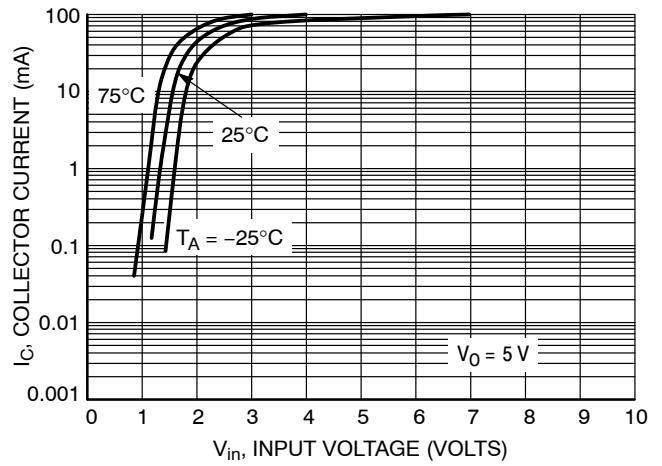

Figure 40. Output Current versus Input Voltage

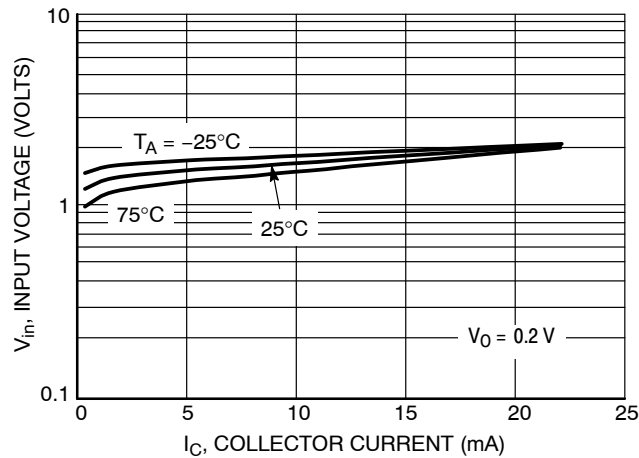

Figure 41. Input Voltage versus Output Current

MUN5111DW1T1G Series, SMUN5111DW1T1G Series

TYPICAL ELECTRICAL CHARACTERISTICS — MUN5132DW1T1G

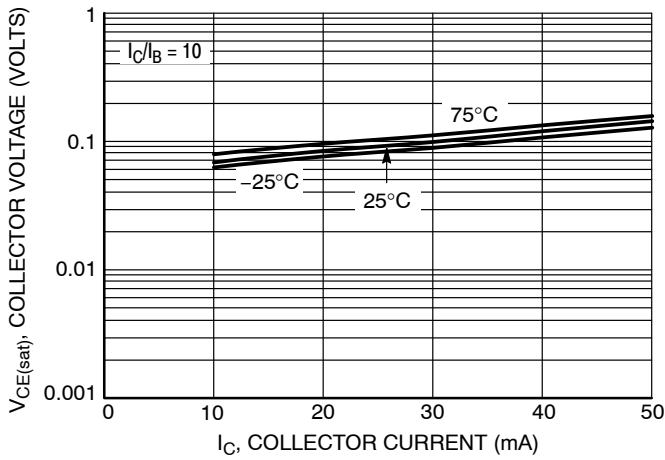

Figure 42.  $V_{CE(sat)}$  versus  $I_C$

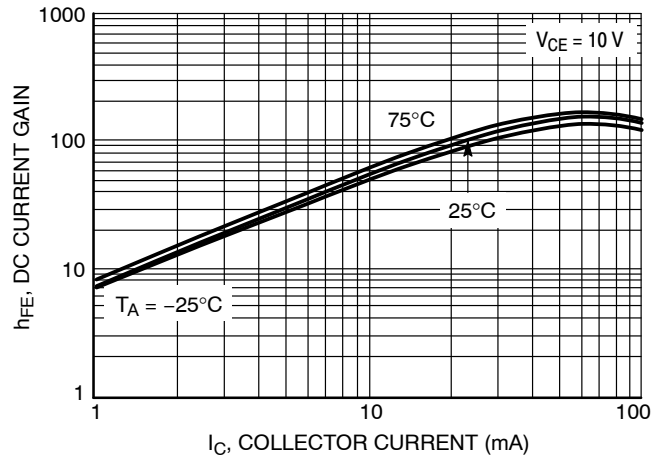

Figure 43. DC Current Gain

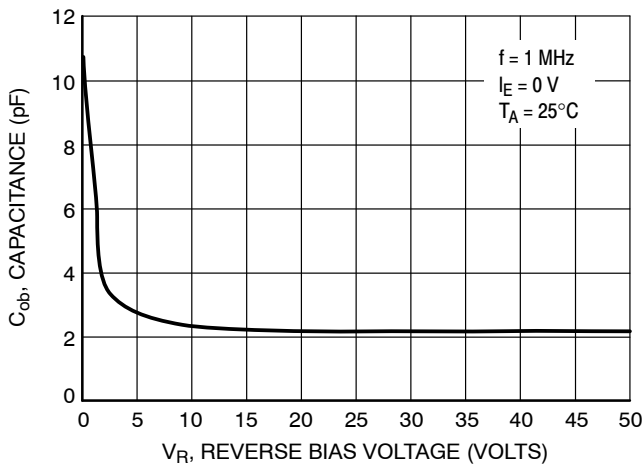

Figure 44. Output Capacitance

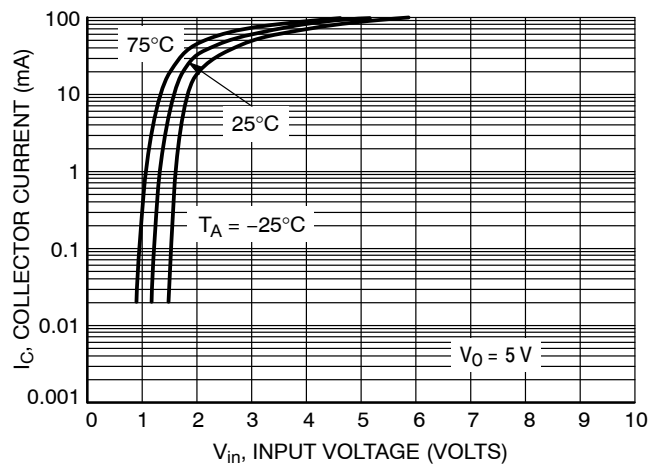

Figure 45. Output Current versus Input Voltage

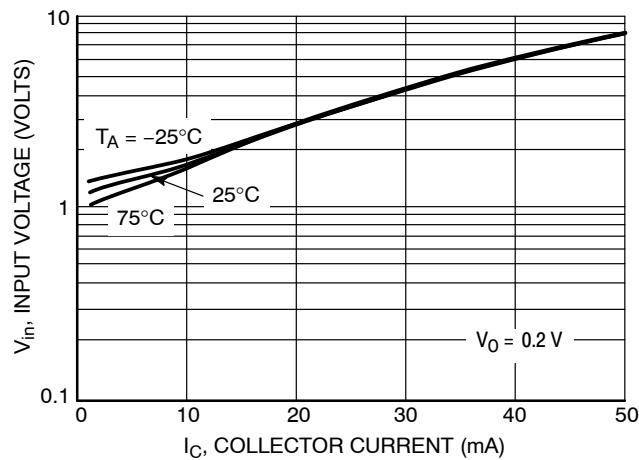

Figure 46. Input Voltage versus Output Current

MUN5111DW1T1G Series, SMUN5111DW1T1G Series

TYPICAL ELECTRICAL CHARACTERISTICS — MUN5133DW1T1G

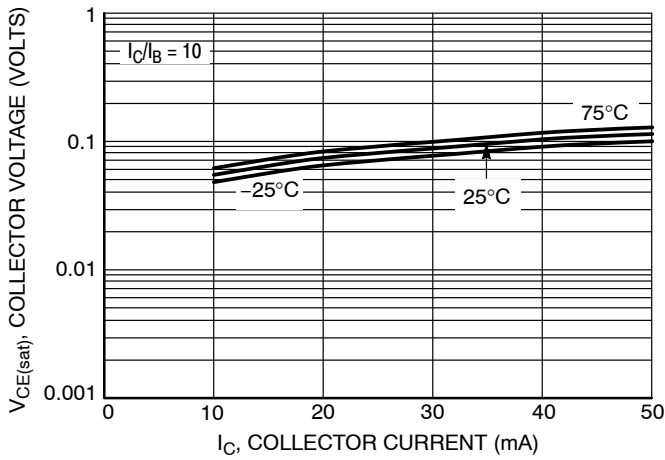

Figure 47.  $V_{CE(sat)}$  versus  $I_C$

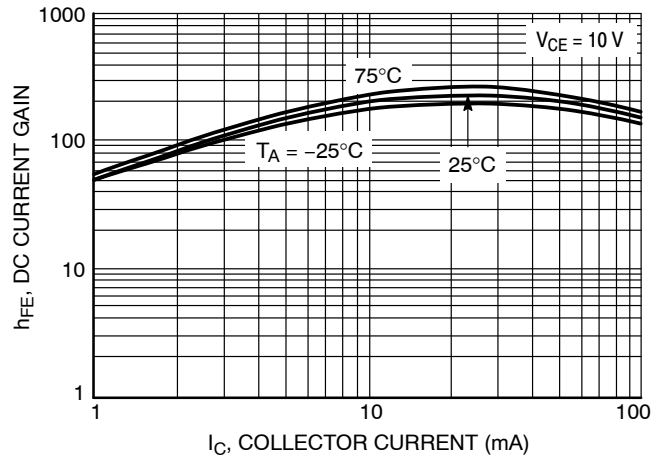

Figure 48. DC Current Gain

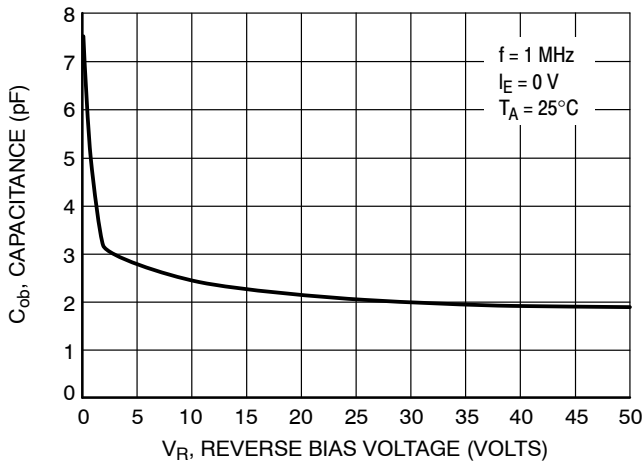

Figure 49. Output Capacitance

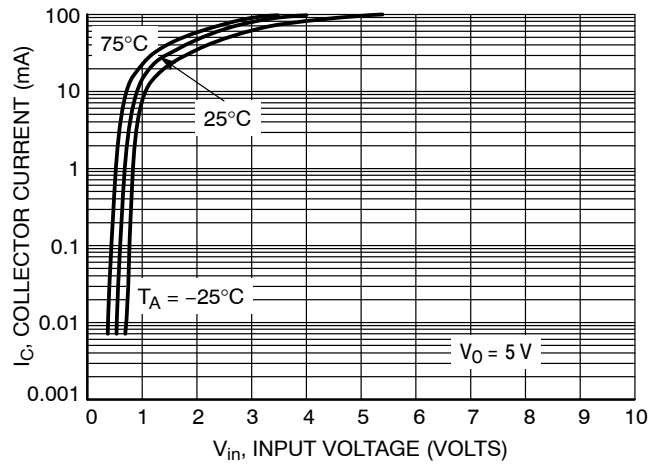

Figure 50. Output Current versus Input Voltage

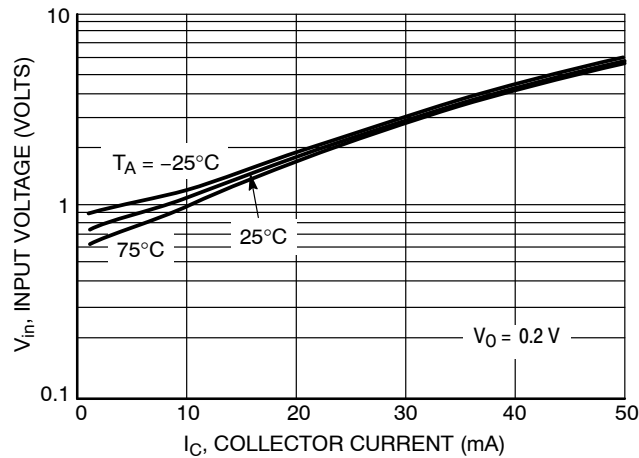

Figure 51. Input Voltage versus Output Current

MUN5111DW1T1G Series, SMUN5111DW1T1G Series

TYPICAL ELECTRICAL CHARACTERISTICS — MUN5134DW1T1G

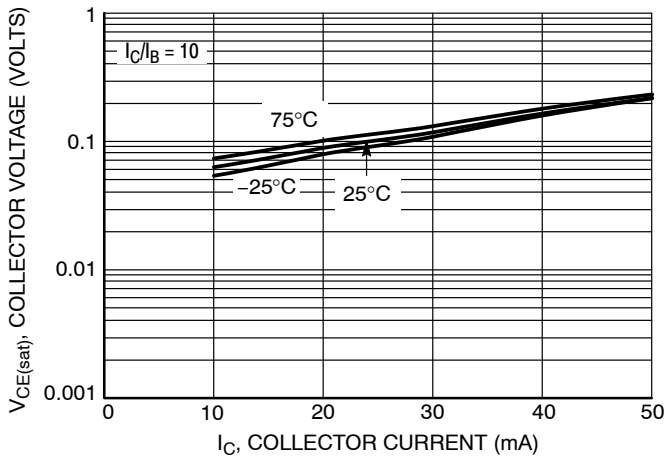

Figure 52.  $V_{CE(sat)}$  versus  $I_C$

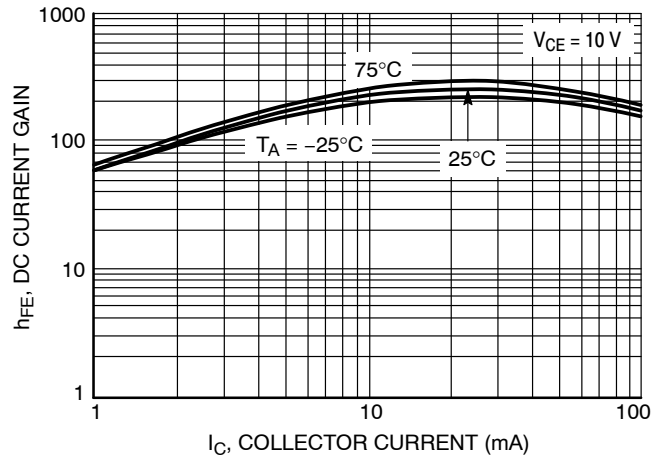

Figure 53. DC Current Gain

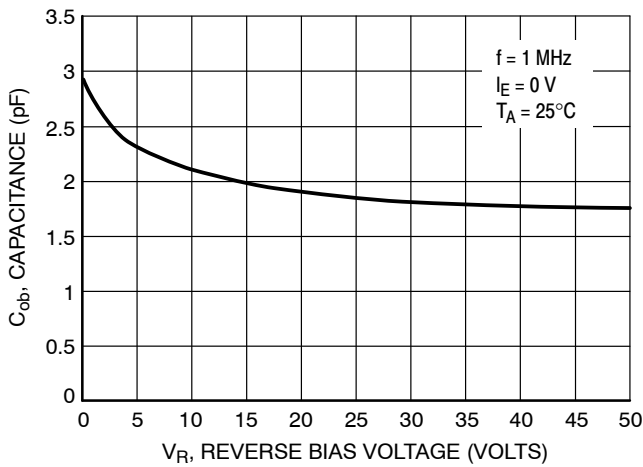

Figure 54. Output Capacitance

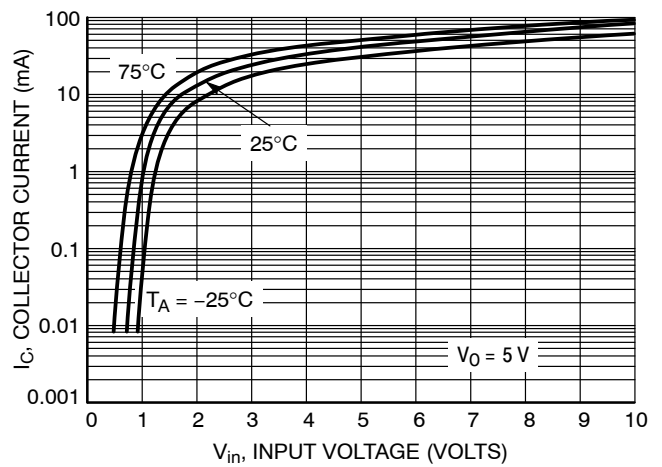

Figure 55. Output Current versus Input Voltage

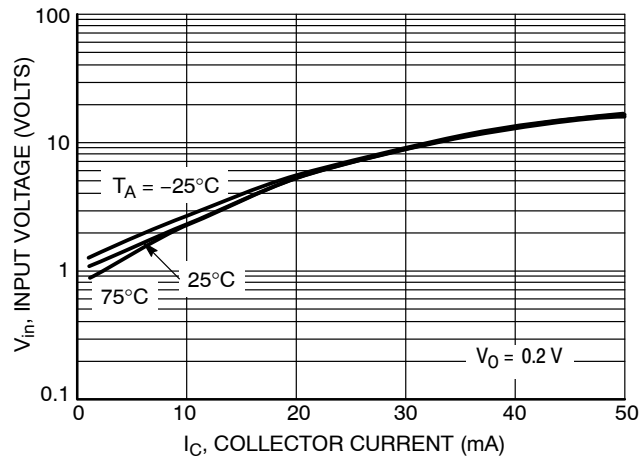

Figure 56. Input Voltage versus Output Current



MUN5111DW1T1G Series, SMUN5111DW1T1G Series

TYPICAL ELECTRICAL CHARACTERISTICS — MUN5135DW1T1G

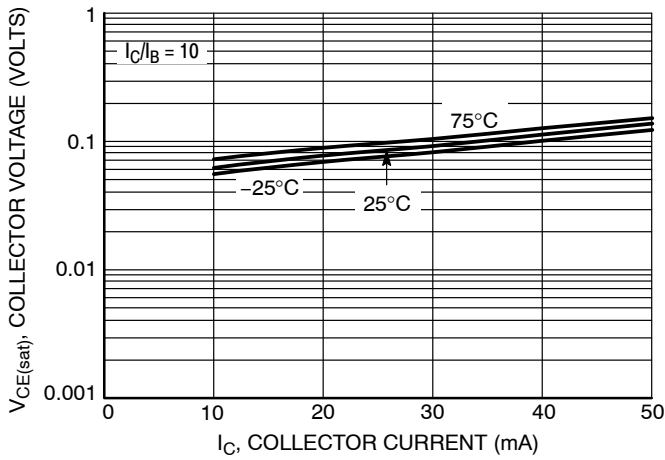

Figure 57.  $V_{CE(sat)}$  versus  $I_C$

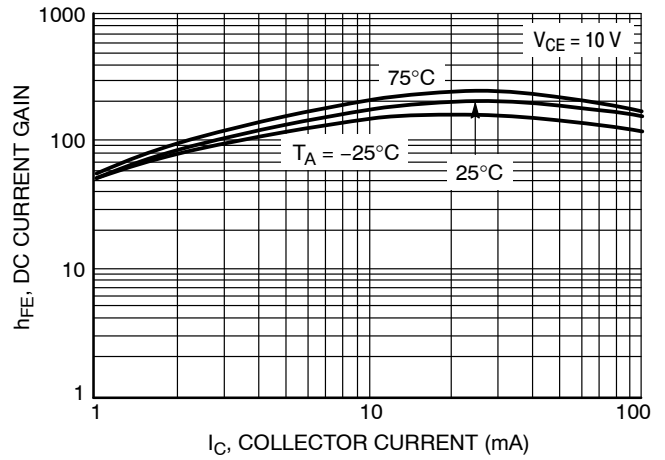

Figure 58. DC Current Gain

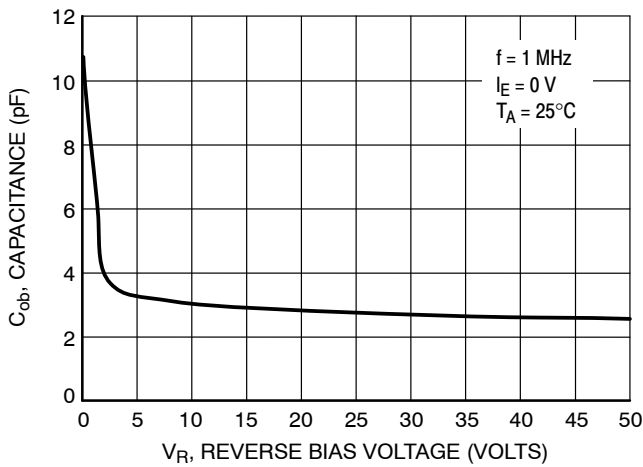

Figure 59. Output Capacitance

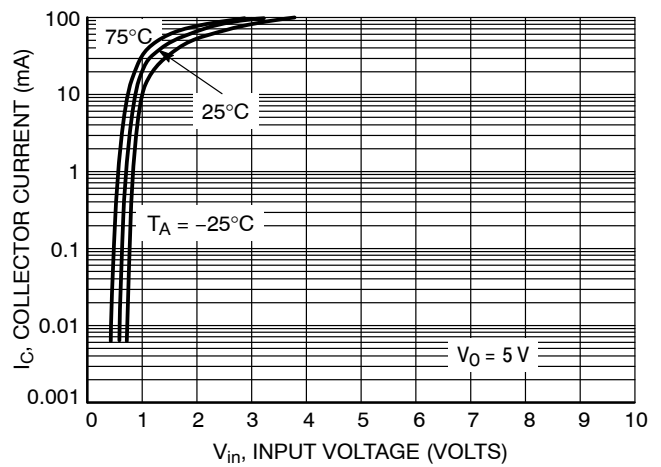

Figure 60. Output Current versus Input Voltage

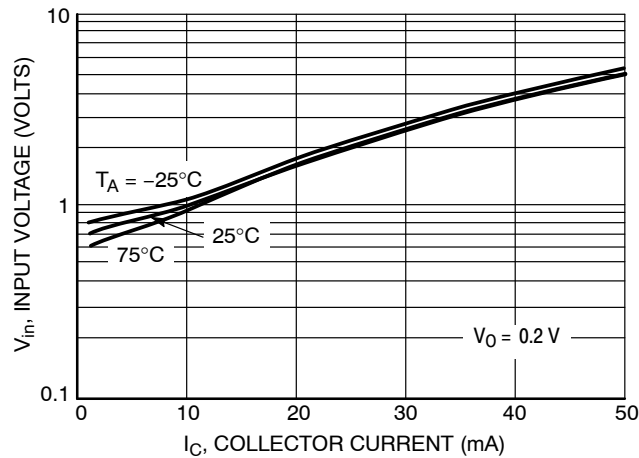

Figure 61. Input Voltage versus Output Current

TYPICAL ELECTRICAL CHARACTERISTICS — MUN5136DW1T1G

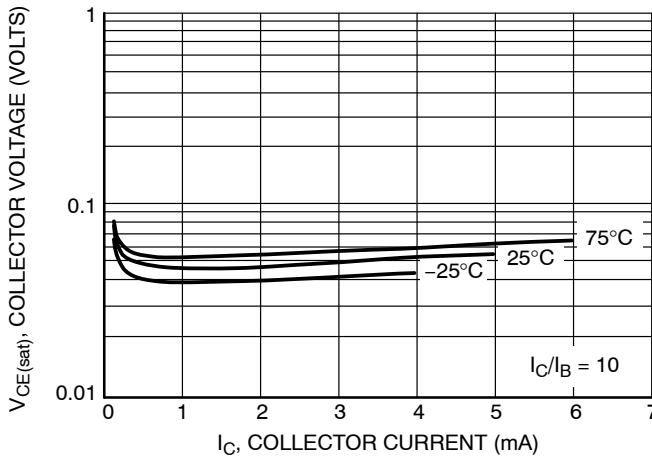

Figure 62.  $V_{CE(sat)}$  versus  $I_C$

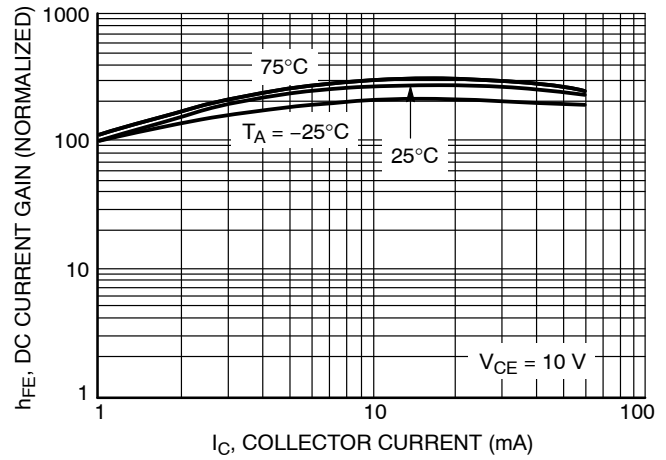

Figure 63. DC Current Gain

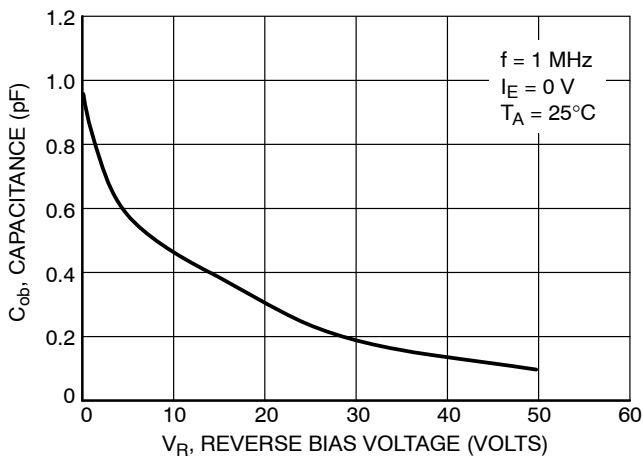

Figure 64. Output Capacitance

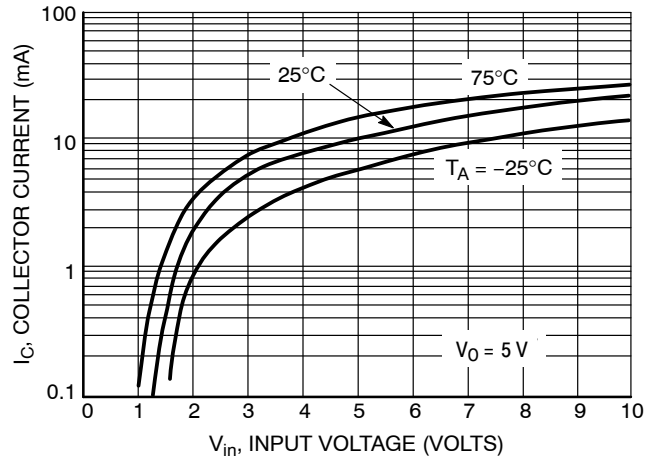

Figure 65. Output Current versus Input Voltage

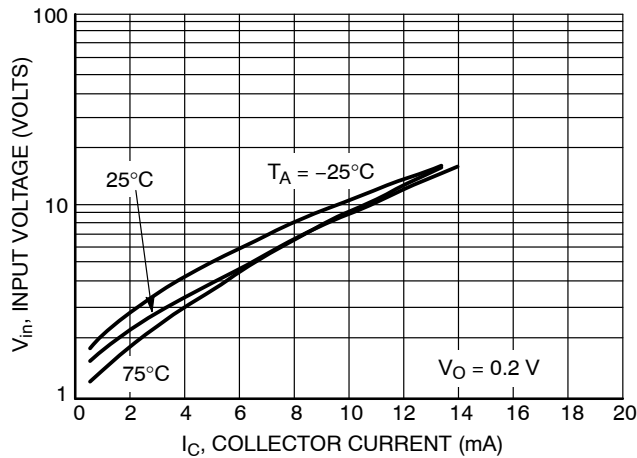

Figure 66. Input Voltage versus Output Current

MUN5111DW1T1G Series, SMUN5111DW1T1G Series

TYPICAL ELECTRICAL CHARACTERISTICS — MUN5137DW1T1G

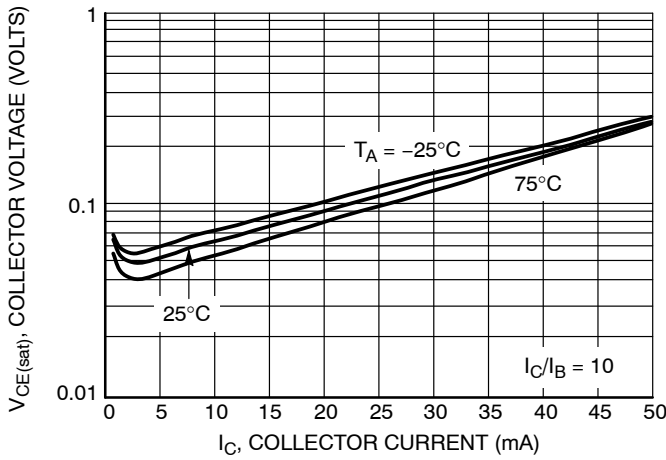

Figure 67.  $V_{CE(sat)}$  versus  $I_C$

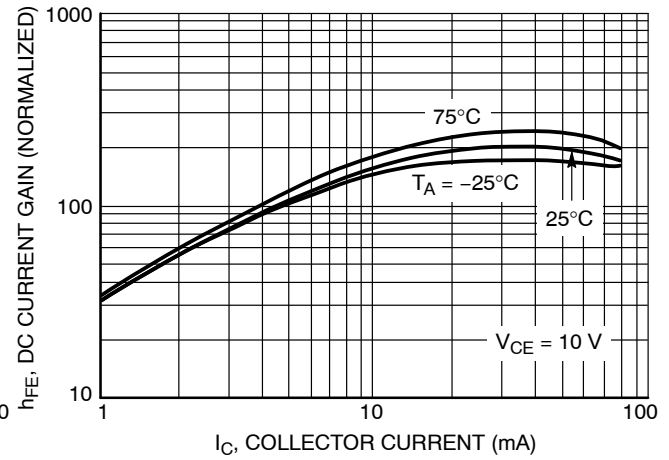

Figure 68. DC Current Gain

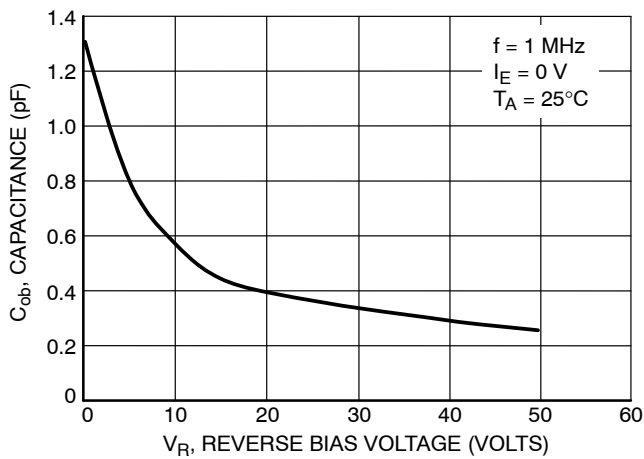

Figure 69. Output Capacitance

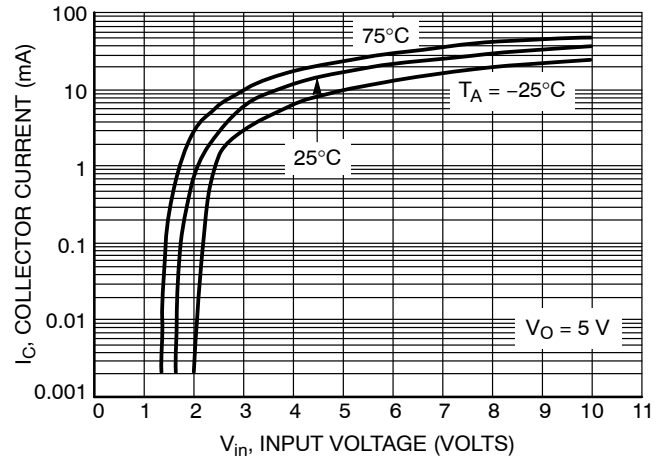

Figure 70. Output Current versus Input Voltage

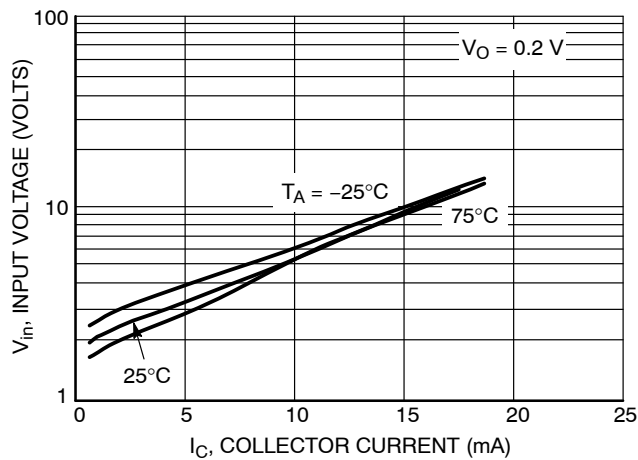
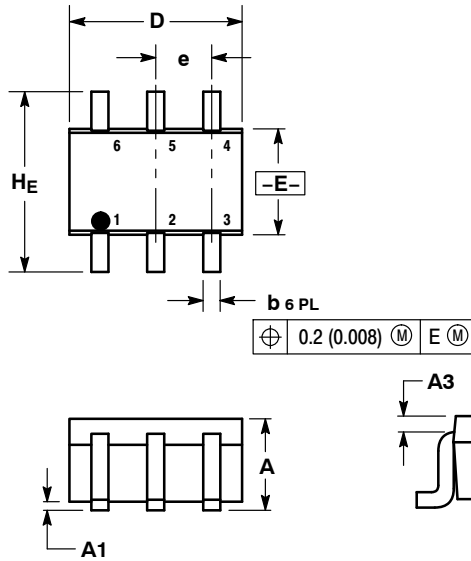

Figure 71. Input Voltage versus Output Current

# MUN5111DW1T1G Series, SMUN5111DW1T1G Series

## PACKAGE DIMENSIONS

SC-88 (SOT-363)  
CASE 419B-02  
ISSUE W



- NOTES:
1. DIMENSIONING AND TOLERANCING PER ANSI Y14.5M, 1982.
  2. CONTROLLING DIMENSION: INCH.
  3. 419B-01 OBSOLETE, NEW STANDARD 419B-02.

DIM	MILLIMETERS			INCHES		
	MIN	NOM	MAX	MIN	NOM	MAX
A	0.80	0.95	1.10	0.031	0.037	0.043
A1	0.00	0.05	0.10	0.000	0.002	0.004
A3	0.20 REF			0.008 REF		
b	0.10	0.21	0.30	0.004	0.008	0.012
C	0.10	0.14	0.25	0.004	0.005	0.010
D	1.80	2.00	2.20	0.070	0.078	0.086
E	1.15	1.25	1.35	0.045	0.049	0.053
e	0.65 BSC			0.026 BSC		
L	0.10	0.20	0.30	0.004	0.008	0.012
HE	2.00	2.10	2.20	0.078	0.082	0.086

- STYLE 1:  
PIN 1. EMITTER 2  
2. BASE 2  
3. COLLECTOR 1  
4. EMITTER 1  
5. BASE 1  
6. COLLECTOR 2

### SOLDERING FOOTPRINT\*

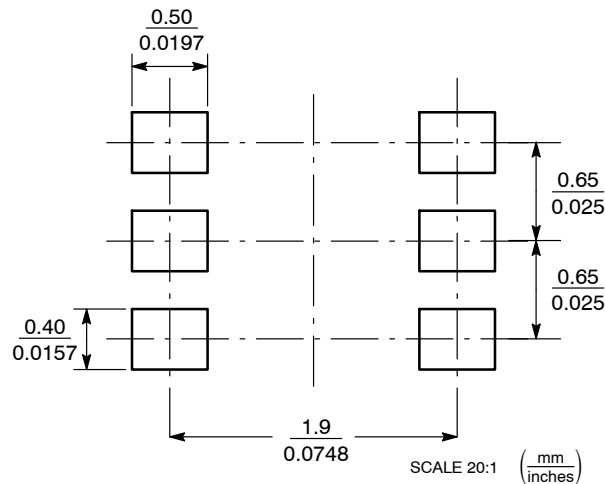

\*For additional information on our Pb-Free strategy and soldering details, please download the ON Semiconductor Soldering and Mounting Techniques Reference Manual, SOLDERRM/D.

ON Semiconductor and are registered trademarks of Semiconductor Components Industries, LLC (SCILLC). SCILLC owns the rights to a number of patents, trademarks, copyrights, trade secrets, and other intellectual property. A listing of SCILLC's product/patent coverage may be accessed at [www.onsemi.com/site/pdf/Patent-Marking.pdf](http://www.onsemi.com/site/pdf/Patent-Marking.pdf). SCILLC reserves the right to make changes without further notice to any products herein. SCILLC makes no warranty, representation or guarantee regarding the suitability of its products for any particular purpose, nor does SCILLC assume any liability arising out of the application or use of any product or circuit, and specifically disclaims any and all liability, including without limitation special, consequential or incidental damages. "Typical" parameters which may be provided in SCILLC data sheets and/or specifications can and do vary in different applications and actual performance may vary over time. All operating parameters, including "Typicals" must be validated for each customer application by customer's technical experts. SCILLC does not convey any license under its patent rights nor the rights of others. SCILLC products are not designed, intended, or authorized for use as components in systems intended for surgical implant into the body, or other applications intended to support or sustain life, or for any other application in which the failure of the SCILLC product could create a situation where personal injury or death may occur. Should Buyer purchase or use SCILLC products for any such unintended or unauthorized application, Buyer shall indemnify and hold SCILLC and its officers, employees, subsidiaries, affiliates, and distributors harmless against all claims, costs, damages, and expenses, and reasonable attorney fees arising out of, directly or indirectly, any claim of personal injury or death associated with such unintended or unauthorized use, even if such claim alleges that SCILLC was negligent regarding the design or manufacture of the part. SCILLC is an Equal Opportunity/Affirmative Action Employer. This literature is subject to all applicable copyright laws and is not for resale in any manner.

### PUBLICATION ORDERING INFORMATION

**LITERATURE FULFILLMENT:**  
Literature Distribution Center for ON Semiconductor  
P.O. Box 5163, Denver, Colorado 80217 USA  
**Phone:** 303-675-2175 or 800-344-3860 Toll Free USA/Canada  
**Fax:** 303-675-2176 or 800-344-3867 Toll Free USA/Canada  
**Email:** [orderlit@onsemi.com](mailto:orderlit@onsemi.com)

**N. American Technical Support:** 800-282-9855 Toll Free  
USA/Canada  
**Europe, Middle East and Africa Technical Support:**  
Phone: 421 33 790 2910  
**Japan Customer Focus Center**  
Phone: 81-3-5817-1050

**ON Semiconductor Website:** [www.onsemi.com](http://www.onsemi.com)  
**Order Literature:** <http://www.onsemi.com/orderlit>  
For additional information, please contact your local Sales Representative

# Mouser Electronics

Authorized Distributor

Click to View Pricing, Inventory, Delivery & Lifecycle Information:

## ON Semiconductor:

[MUN5111DW1T1](#) [MUN5111DW1T1G](#) [MUN5112DW1T1](#) [MUN5112DW1T1G](#) [MUN5113DW1T1](#) [MUN5114DW1T1](#)  
[MUN5114DW1T1G](#) [MUN5115DW1T1](#) [MUN5115DW1T1G](#) [MUN5116DW1T1](#) [MUN5116DW1T1G](#) [MUN5130DW1T1](#)  
[MUN5130DW1T1G](#) [MUN5131DW1T1](#) [MUN5131DW1T1G](#) [MUN5132DW1T1](#) [MUN5132DW1T1G](#) [MUN5133DW1T1](#)  
[MUN5133DW1T1G](#) [MUN5134DW1T1](#) [MUN5134DW1T1G](#) [MUN5135DW1T1](#) [MUN5135DW1T1G](#) [MUN5137DW1T1](#)  
[MUN5137DW1T1G](#) [MUN5113DW1T1G](#) [SMUN5116DW1T1G](#) [SMUN5115DW1T1G](#) [SMUN5111DW1T1G](#)