

# TYPES SN54184, SN54185A, SN74184, SN74185A BCD-TO-BINARY AND BINARY-TO-BCD CONVERTERS

FEBRUARY 1971 — REVISED DECEMBER 1972

## SN54184, SN74184 BCD-TO-BINARY CONVERTERS SN54185A, SN74185A BINARY-TO-BCD CONVERTERS

SN54184, SN54185A . . . J OR W PACKAGE  
SN74184, SN74185A . . . J OR N PACKAGE  
(TOP VIEW)

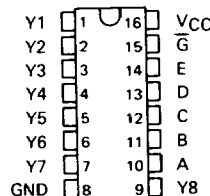

### description

These monolithic converters are derived from the custom MSI 256-bit read-only memories SN5488 and SN7488. Emitter connections are made to provide direct read-out of converted codes at outputs Y8 through Y1 as shown in the function tables. These converters demonstrate the versatility of a read-only memory in that an unlimited number of reference tables or conversion tables may be built into a system using economical, customized read-only memories. Both of these converters comprehend that the least significant bits (LSB) of the binary and BCD codes are logically equal, and in each case the LSB bypasses the converter as illustrated in the typical applications. This means that a 6-bit converter is produced in each case. Both devices are cascadable to N bits.

An overriding enable input is provided on each converter which, when taken high, inhibits the function, causing all outputs to go high. For this reason, and to minimize power consumption, unused outputs Y7 and Y8 of the '185A and all "don't care" conditions of the '184 are programmed high. The outputs are of the open-collector type.

The SN54184 and SN54185A are characterized for operation over the full military temperature range of  $-55^{\circ}\text{C}$  to  $125^{\circ}\text{C}$ ; the SN74184 and SN74185A are characterized for operation from  $0^{\circ}\text{C}$  to  $70^{\circ}\text{C}$ .

### SN54184 and SN74184 BCD-to-binary converters

The 6-bit BCD-to-binary function of the SN54184 and SN74184 is analogous to the algorithm:

- Shift BCD number right one bit and examine each decade. Subtract three from each 4-bit decade containing a binary value greater than seven.
- Shift right, examine, and correct after each shift until the least significant decade contains a number smaller than eight and all other converted decades contain zeros.

TABLE I  
SN54184, SN74184  
PACKAGE COUNT AND DELAY TIMES  
FOR BCD-TO-BINARY CONVERSION

INPUT (DECADES)	PACKAGES REQUIRED	TOTAL DELAY TIMES (ns)	
		TYP	MAX
2	2	56	80
3	6	140	200
4	11	196	280
5	19	280	400
6	28	364	520

In addition to BCD-to-binary conversion, the SN54184 and SN74184 are programmed to generate BCD 9's complement or BCD 10's complement. Again, in each case, one bit of the complement code is logically equal to one of the BCD bits; therefore, these complements can be produced on three lines. As outputs Y6, Y7, and Y8 are not required in the BCD-to-binary conversion, they are utilized to provide these complement codes as specified in the function table (following page, right) when the devices are connected as shown above the function table.

# TYPES SN54184, SN74184 BCD-TO-BINARY AND BINARY-TO-BCD CONVERTERS

SN54184 and SN74184 BCD-to-binary converters (continued)

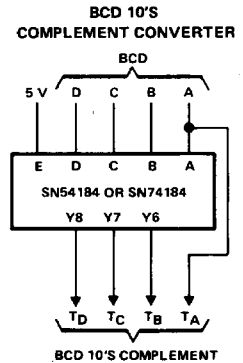
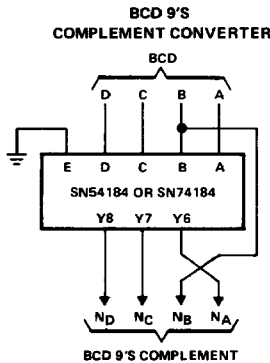
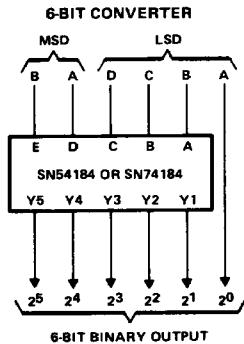

**FUNCTION TABLE  
BCD-TO-BINARY  
CONVERTER**

BCD WORDS	INPUTS (See Note A)					G	OUTPUTS (See Note B)					
	E	D	C	B	A		Y5	Y4	Y3	Y2	Y1	
0-1	L	L	L	L	L	L	L	L	L	L	L	L
2-3	L	L	L	L	H	L	L	L	L	H	L	L
4-5	L	L	L	H	L	L	L	L	H	L	L	L
6-7	L	L	L	H	H	L	L	L	H	L	H	H
8-9	L	L	H	L	L	L	L	L	H	L	L	L
10-11	L	H	L	L	L	L	L	L	H	L	H	H
12-13	L	H	L	L	H	L	L	L	H	H	L	L
14-15	L	H	L	H	L	L	L	L	H	H	H	H
16-17	L	H	L	H	H	L	L	H	L	L	L	L
18-19	L	H	H	L	L	L	L	L	H	L	L	H
20-21	H	L	L	L	L	L	L	L	H	L	H	L
22-23	H	L	L	L	H	L	L	H	L	H	H	H
24-25	H	L	L	H	L	L	L	H	H	L	L	L
26-27	H	L	L	H	H	L	L	H	H	L	H	H
28-29	H	L	H	L	L	L	L	H	H	H	L	L
30-31	H	H	L	L	L	L	L	L	H	H	H	H
32-33	H	H	L	L	H	L	H	L	L	L	L	L
34-35	H	H	L	H	L	L	H	L	L	L	H	H
36-37	H	H	L	H	H	L	H	L	L	H	L	L
38-39	H	H	H	L	L	L	L	H	L	L	H	H
ANY	X	X	X	X	X	H	H	H	H	H	H	H

H = high level, L = low level, X = irrelevant

NOTES: A. Input conditions other than those shown produce highs at outputs Y1 through Y5.

B. Outputs Y6, Y7, and Y8 are not used for BCD-to-binary conversion.

**FUNCTION TABLE  
BCD 9'S OR BCD 10'S  
COMPLEMENT CONVERTER**

BCD WORD	INPUTS (See Note C)					G	OUTPUTS (See Note D)			
	E <sup>†</sup>	D	C	B	A		Y8	Y7	Y6	
0	L	L	L	L	L	L	L	H	L	H
1	L	L	L	L	H	L	L	H	L	L
2	L	L	L	H	L	L	L	L	H	H
3	L	L	L	H	H	L	L	L	H	L
4	L	L	H	L	L	L	L	L	H	H
5	L	L	H	L	H	L	L	L	H	L
6	L	L	H	H	L	L	L	L	L	H
7	L	L	H	H	H	L	L	L	L	L
8	L	H	L	L	L	L	L	L	L	H
9	L	H	L	L	H	L	L	L	L	L
0	H	L	L	L	L	L	L	L	L	L
1	H	L	L	L	H	L	L	H	L	L
2	H	L	L	H	L	L	L	H	L	L
3	H	L	L	H	H	L	L	L	H	H
4	H	L	H	L	L	L	L	L	H	H
5	H	L	H	L	H	L	L	L	H	L
6	H	L	H	H	L	L	L	L	H	L
7	H	L	H	H	H	L	L	L	L	H
8	H	H	L	L	L	L	L	L	L	H
9	H	H	L	L	H	L	L	L	L	L
ANY	X	X	X	X	X	H	H	H	H	H

H = high level, L = low level, X = irrelevant

NOTES: C. Input conditions other than those shown produce highs at outputs Y6, Y7, and Y8.

D. Outputs Y1 through Y5 are not used for BCD 9's or BCD 10's complement conversion.

<sup>†</sup>When these devices are used as complement converters, input E is used as a mode control. With this input low, the BCD 9's complement is generated; when it is high, the BCD 10's complement is generated.

# TYPES SN54185A, SN74185A BCD-TO-BINARY AND BINARY-TO-BCD CONVERTERS

## SN54185A and SN74185A binary-to-BCD converters

The function performed by these 6-bit binary-to-BCD converters is analogous to the algorithm:

- a. Examine the three most significant bits. If the sum is greater than four, add three and shift left one bit.
- b. Examine each BCD decade. If the sum is greater than four, add three and shift left one bit.
- c. Repeat step b until the least-significant binary bit is in the least-significant BCD location.

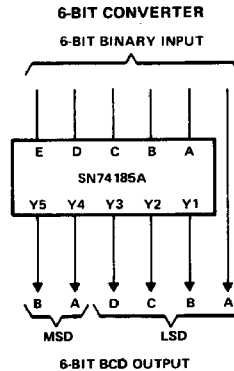

TABLE II

SN54185A, SN74185A

PACKAGE COUNT AND DELAY TIMES  
FOR BINARY-TO-BCD CONVERSION

INPUT (BITS)	PACKAGES REQUIRED	TOTAL DELAY TIME (ns)	
		TYP	MAX
4 to 6	1	25	40
7 or 8	3	50	80
9	4	75	120
10	6	100	160
11	7	125	200
12	8	125	200
13	10	150	240
14	12	175	280
15	14	175	280
16	16	200	320
17	19	225	360
18	21	225	360
19	24	250	400
20	27	275	440

FUNCTION TABLE

BINARY WORDS	INPUTS						OUTPUTS							
	BINARY SELECT					ENABLE	Y8	Y7	Y6	Y5	Y4	Y3	Y2	Y1
	E	D	C	B	A	G								
0-1	L	L	L	L	L	L	H	H	L	L	L	L	L	L
2-3	L	L	L	L	H	L	H	H	L	L	L	L	L	H
4-5	L	L	L	H	L	L	H	H	L	L	L	L	H	L
6-7	L	L	L	H	H	L	H	H	L	L	L	L	H	H
8-9	L	L	H	L	L	L	H	H	L	L	L	H	L	L
10-11	L	L	H	L	H	L	H	H	L	L	H	L	L	L
12-13	L	L	H	H	L	L	H	H	L	L	H	L	L	H
14-15	L	L	H	H	H	L	H	H	L	L	H	L	H	L
16-17	L	H	L	L	L	L	H	H	L	L	H	L	H	H
18-19	L	H	L	L	H	L	H	H	L	L	H	H	L	L
20-21	L	H	L	H	L	L	H	H	L	H	L	L	L	L
22-23	L	H	L	H	H	L	H	H	L	H	L	L	L	H
24-25	L	H	H	L	L	L	H	H	L	H	L	L	H	L
26-27	L	H	H	L	H	L	H	H	L	H	L	L	H	H
28-29	L	H	H	H	L	L	H	H	L	H	L	H	L	L
30-31	L	H	H	H	H	L	H	H	L	H	H	L	L	L
32-33	H	L	L	L	L	L	H	H	L	L	H	L	L	H
34-35	H	L	L	L	H	L	H	H	L	H	L	H	L	L
36-37	H	L	L	H	L	L	H	H	L	H	L	H	L	H
38-39	H	L	L	H	H	L	H	H	L	H	H	L	L	L
40-41	H	L	H	L	L	L	H	H	H	L	L	L	L	L
42-43	H	L	H	L	H	L	H	H	L	L	L	L	L	H
44-45	H	L	H	H	L	L	H	H	H	L	L	L	H	L
46-47	H	L	H	H	H	L	H	H	L	L	L	L	H	H
48-49	H	H	L	L	L	L	H	H	L	L	H	L	L	L
50-51	H	H	L	L	H	L	H	H	L	H	L	L	L	L
52-53	H	H	L	H	L	L	H	H	L	H	L	L	L	H
54-55	H	H	L	H	H	L	H	H	L	H	L	L	H	L
56-57	H	H	H	L	L	L	H	H	H	L	H	L	H	H
58-59	H	H	H	L	H	L	H	H	L	H	H	L	L	L
60-61	H	H	H	H	L	L	H	H	H	L	L	L	L	L
62-63	H	H	H	H	H	L	H	H	H	L	L	L	L	H
ALL	X	X	X	X	X	X	H	H	H	H	H	H	H	H

H = high level, L = low level, X = irrelevant

3

TTL DEVICES

# TYPES SN54184, SN54185A, SN74184, SN74185A BCD-TO-BINARY AND BINARY-TO-BCD CONVERTERS

## absolute maximum ratings over operating free-air temperature range (unless otherwise noted)

Supply voltage, $V_{CC}$ (see Note 1)	7 V
Input voltage	5.5 V
Operating free-air temperature range: SN54184, SN54185A	-55°C to 125°C
SN74184, SN74185A	0°C to 70°C
Storage temperature range	-65°C to 150°C

NOTE 1: Voltage values are with respect to network ground terminal.

## recommended operating conditions

	SN54184, SN54185A			SN74184, SN74185A			UNIT
	MIN	NOM	MAX	MIN	NOM	MAX	
Supply voltage, $V_{CC}$	4.5	5	5.5	4.75	5	5.25	V
Low-level output current, $I_{OL}$			12			12	mA
Operating free-air temperature, $T_A$	-55		125	0		70	°C

## electrical characteristics over recommended operating free-air temperature range (unless otherwise noted)

PARAMETER	TEST CONDITIONS†	MIN	TYP‡	MAX	UNIT
$V_{IH}$ High-level input voltage		2			V
$V_{IL}$ Low-level input voltage			0.8		V
$V_{IK}$ Input clamp voltage			-1.5		V
$I_{OH}$ High-level output current	$V_{CC} = \text{MIN}, I_I = -12 \text{ mA}$			100	$\mu\text{A}$
$V_{OL}$ Low-level output voltage	$V_{CC} = \text{MIN}, V_{IH} = 2 \text{ V}, V_{IL} = 0.8 \text{ V}, V_{OH} = 5.5 \text{ V}$		0.4		V
$I_I$ Input current at maximum input voltage	$V_{CC} = \text{MIN}, V_{IH} = 2 \text{ V}, V_{IL} = 0.8 \text{ V}, I_{OL} = 12 \text{ mA}$			1	mA
$I_{IH}$ High-level input current	$V_{CC} = \text{MAX}, V_I = 5.5 \text{ V}$			40	$\mu\text{A}$
$I_{IL}$ Low-level input current	$V_{CC} = \text{MAX}, V_I = 2.4 \text{ V}$			-1	mA
$I_{CCH}$ Supply current, all outputs high	$V_{CC} = \text{MAX}$		50		mA
$I_{CCL}$ Supply current, all programmed outputs low			62	99	

†For conditions shown as MIN or MAX, use the appropriate value specified under recommended operating conditions for the applicable type.  
‡All typical values are at  $V_{CC} = 5 \text{ V}, T_A = 25^\circ\text{C}$ .

## switching characteristics, $V_{CC} = 5 \text{ V}, T_A = 25^\circ\text{C}$

PARAMETER	TEST CONDITIONS	MIN	TYP	MAX	UNIT
$t_{PLH}$ Propagation delay time, low-to-high-level output from enable $\bar{G}$	$C_L = 30 \text{ pF}$	19	30		ns
$t_{PHL}$ Propagation delay time, high-to-low-level output from enable $\bar{G}$	$R_{L1} = 300 \Omega$	22	35		ns
$t_{PLH}$ Propagation delay time, low-to-high-level output from binary select	$R_{L2} = 600 \Omega$	27	40		ns
$t_{PHL}$ Propagation delay time, high-to-low-level output from binary select	See Figure 1 and Note 2	23	40		ns

3

TTL DEVICES

# TYPES SN54184, SN54185A, SN74184, SN74185A BCD-TO-BINARY AND BINARY-TO-BCD CONVERTERS

schematics of inputs and outputs

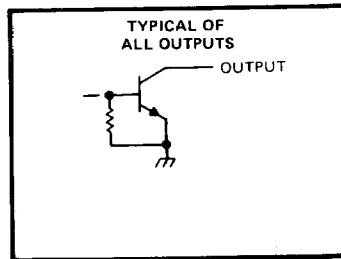
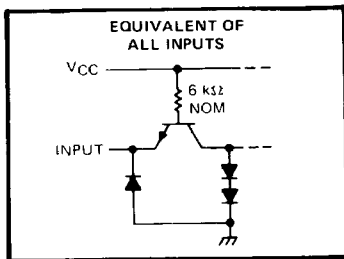

## PARAMETER MEASUREMENT INFORMATION

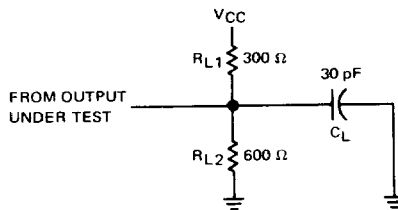

$C_L$  includes probe and jig capacitance.

LOAD CIRCUIT  
FIGURE 1

NOTE 2: See General Information Section for load circuits and voltage waveforms.

# TYPES SN54184, SN74184 BCD-TO-BINARY CONVERTERS

## TYPICAL APPLICATION DATA SN54184, SN74184

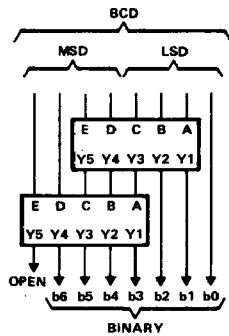

FIGURE 2—BCD-TO-BINARY CONVERTER  
FOR TWO BCD DECADES

MSD—most significant decade  
LSD—least significant decade  
Each rectangle represents an SN54184 or SN74184

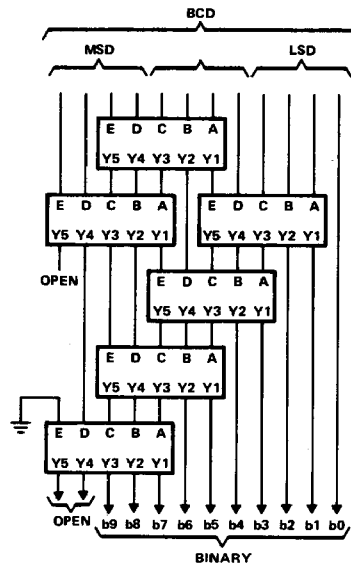

FIGURE 3—BCD-TO-BINARY CONVERTER  
FOR THREE BCD DECADES

3

TTL DEVICES



**TYPES SN54185A, SN74185A  
BINARY-TO-BCD CONVERTERS**

**TYPICAL APPLICATION DATA  
SN54185A, SN74185A**

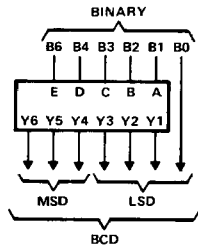

**FIGURE 5—6-BIT BINARY-TO-BCD CONVERTER**

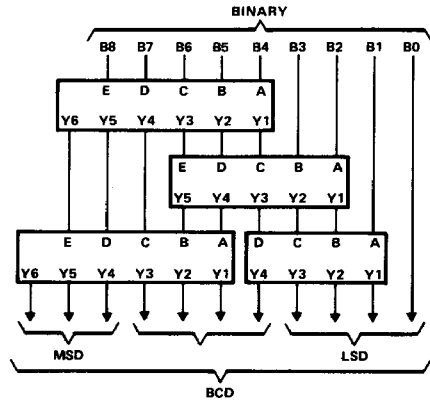

**FIGURE 7—9-BIT BINARY-TO-BCD CONVERTER**

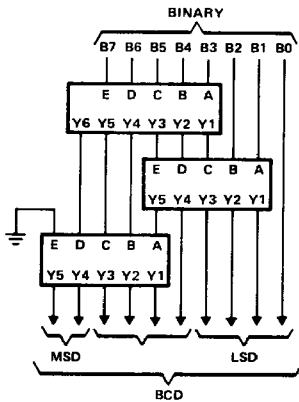

**FIGURE 6—8-BIT BINARY-TO-BCD CONVERTER**

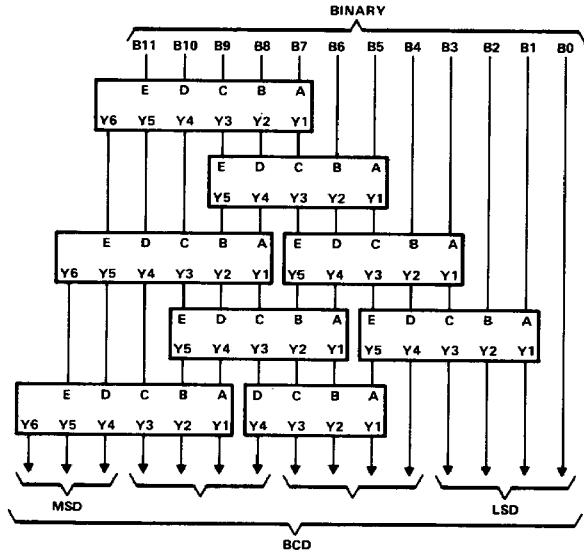

**FIGURE 8—12-BIT BINARY-TO-BCD CONVERTER (SEE NOTE B)**

MSD—Most significant decade  
LSD—Least significant decade

NOTES: A. Each rectangle represents an SN54185A or an SN74185A.  
B. All unused E inputs are grounded.

**3**  
**TTL DEVICES**



**TYPES SN54185A, SN74185A  
BINARY-TO-BCD CONVERTERS**

**TYPICAL APPLICATION DATA  
SN54185A, SN74185A**

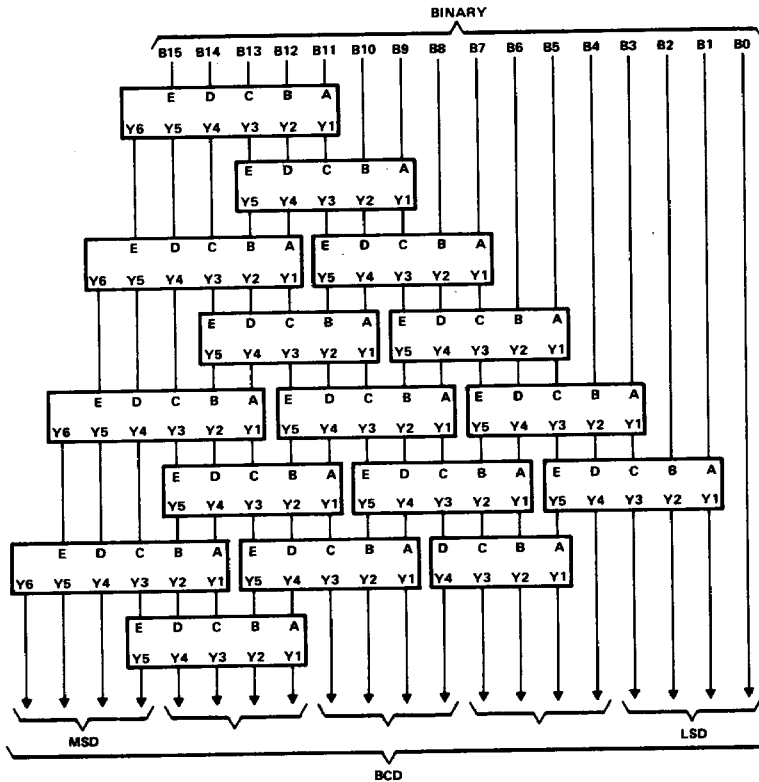

**FIGURE 9—16 BIT BINARY-TO-BCD  
CONVERTER (SEE NOTE B)**

MSD—most significant decade

LSD—least significant decade

NOTES: A. Each rectangle represents an SN54185A or SN74185A.

B. All unused E inputs are grounded.