

Aspire 3610 Series

Service Guide

Service guide files and updates are available on the ACER/CSD web; for more information, please refer to <http://csd.acer.com.tw>

PRINTED IN TAIWAN

Revision History

Please refer to the table below for the updates made on Aspire 3610 service guide.

Date	Chapter	Updates
2005/07/21	Chapter 1	Revise information on "Hardware Specification and Configurations".
2005/10/24	Chapter 1	Revise battery vendor and specification on page 24.

Copyright

Copyright © 2005 by Acer Incorporated. All rights reserved. No part of this publication may be reproduced, transmitted, transcribed, stored in a retrieval system, or translated into any language or computer language, in any form or by any means, electronic, mechanical, magnetic, optical, chemical, manual or otherwise, without the prior written permission of Acer Incorporated.

Disclaimer

The information in this guide is subject to change without notice.

Acer Incorporated makes no representations or warranties, either expressed or implied, with respect to the contents hereof and specifically disclaims any warranties of merchantability or fitness for any particular purpose. Any Acer Incorporated software described in this manual is sold or licensed "as is". Should the programs prove defective following their purchase, the buyer (and not Acer Incorporated, its distributor, or its dealer) assumes the entire cost of all necessary servicing, repair, and any incidental or consequential damages resulting from any defect in the software.

Acer is a registered trademark of Acer Corporation.

Intel is a registered trademark of Intel Corporation.

Pentium and Pentium II/III are trademarks of Intel Corporation.

Other brand and product names are trademarks and/or registered trademarks of their respective holders.

Conventions

The following conventions are used in this manual:

SCREEN MESSAGES	Denotes actual messages that appear on screen.
NOTE	Gives bits and pieces of additional information related to the current topic.
WARNING	Alerts you to any damage that might result from doing or not doing specific actions.
CAUTION	Gives precautionary measures to avoid possible hardware or software problems.
IMPORTANT	Reminds you to do specific actions relevant to the accomplishment of procedures.

Preface

Before using this information and the product it supports, please read the following general information.

1. This Service Guide provides you with all technical information relating to the BASIC CONFIGURATION decided for Acer's "global" product offering. To better fit local market requirements and enhance product competitiveness, your regional office MAY have decided to extend the functionality of a machine (e.g. add-on card, modem, or extra memory capability). These LOCALIZED FEATURES will NOT be covered in this generic service guide. In such cases, please contact your regional offices or the responsible personnel/channel to provide you with further technical details.
2. Please note WHEN ORDERING FRU PARTS, that you should check the most up-to-date information available on your regional web or channel. If, for whatever reason, a part number change is made, it will not be noted in the printed Service Guide. For ACER-AUTHORIZED SERVICE PROVIDERS, your Acer office may have a DIFFERENT part number code to those given in the FRU list of this printed Service Guide. You MUST use the list provided by your regional Acer office to order FRU parts for repair and service of customer machines.

Chapter 1	System Specifications	1
	Features	1
	System Block Diagram	3
	Board Layout	4
	Top View	4
	Bottom View	5
	An Aspire tour	7
	Front View	7
	Closed Front View	8
	Left View	9
	Right View	9
	Rear Panel	10
	Bottom Panel	11
	Indicators	11
	Launch Keys	12
	Touchpad	13
	Touchpad Basics	13
	Using the Keyboard	15
	Lock Keys and embedded numeric keypad	15
	Windows Keys	15
	Hot Keys	16
	Special Key	17
	Hardware Specifications and Configurations	19
Chapter 2	System Utilities	29
	BIOS Setup Utility	29
	Navigating the BIOS Utility	30
	Information	31
	Main	32
	Security	34
	Boot	38
	Exit	39
	BIOS Flash Utility	40
Chapter 3	Machine Disassembly and Replacement	41
	General Information	42
	Before You Begin	42
	Disassembly Procedure Flowchart	43
	Removing the Battery Pack	45
	Removing the Memory/the HDD Module/the Wireless LAN Card/ the ODD Module and the LCD Module	46
	Removing the Memory and the HDD Module	46
	Removing the Wireless LAN Card	46
	Removing the ODD Module	47
	Removing the LCD Module	47
	Disassembling the Main Unit	49
	Separate the Main Unit Into the Upper and the Lower Case Assembly	49
	Disassembling the Upper Case Assembly	49
	Disassembling the Lower Case Assembly	50
	Disassembling the LCD Module	53
	Disassembling the External Modules	54
	Disassembling the HDD Module	54

Table of Contents

Chapter 4	Troubleshooting	55
	System Check Procedures	56
	External Diskette Drive Check	56
	External CD-ROM Drive Check	56
	Keyboard or Auxiliary Input Device Check	56
	Memory check	57
	Power System Check	57
	Touchpad Check	59
	Power-On Self-Test (POST) Error Message	60
	Index of Error Messages	61
	Phoenix BIOS Beep Codes	64
	Index of Symptom-to-FRU Error Message	68
	Intermittent Problems	71
	Undetermined Problems	72
Chapter 5	FRU (Field Replaceable Unit) List	73
	Aspire 3610 Exploded Diagram	74

System Specifications

Features

Below is a brief summary of the computer's many feature:

Platform and memroy

- Intel® Pentium® M 725A Processor (2 MB L2 cache, 1.6GHz, 400MHz FSB)
- Intel® Celeron M 360/370/380 Processor (1 MB L2 cache, 1.40/1.50/1.60GHz, 400MHz FSB)
- Intel® 910GML+ICH6M
- Two DIMM slots support 128MB to 2GB system memory

Display

- Thin-Film Transistor (TFT) displaying at :
 - ▶15.0" XGA (1024 x 768)
 - ▶15.4" WXGA (1280 x 800)
 - ▶15.4" WXGA (1280 x 800) Acer CrystalBrite color TFT LCD
- Intel® GMA 900 graphics with up to 128MB of shared memory supporting, Microsoft® DirectX® 9.0
- Dual independent display support
- MPEG-2/DVD hardware-assisted capability

Storage subsystem

- 40/60/80 GB ATA/100 hard disk drive
- Optical drive options:
 - ▶DVD-Dual double layer drive
 - ▶DVD/CD-RW combo drive

Input devices

- 88/89-key keyboard
- Built-in touchpad with 4-way integrated scroll button
- Four easy-launch buttons
- Two front-access buttons: WLAN LED-button and Bluetooth® LED-button

Audio

- Audio system with two built-in speakers
- Sound Blaster Pro™ and MS-Sound compatible
- Built-in microphone

Communication

- Modem: 56K ITU V.92 modem with PTT approval; wake-on ring ready
- LAN: 10/100 Mbps Fast Ethernet (for selected models); wake-on-LAN ready

-
- WLAN (manufacturing option): integrated Acer InviLink™ 802.11b/g WI-Fi® CERTIFIED™ solution; Acer SignalUp technology support
 - WPAN (manufacturing option): integrated Bluetooth®

Human-centric design and ergonomics

- Rugged, yet extremely portable design
- Stylish appearance
- Full-size keyboard with four programmable launch keys
- Ergonomically-centered touchpad pointing device
- Internet 4-way scroll button

I/O Ports

- Four USB 2.0 ports
- Ethernet (RJ-45) port
- Modem (RJ-11) port
- External display (VGA) port
- Microphone/line-in jack
- Headphones/speakers/line-out port
- Type II PC Card slot
- DC-in jack for AC adaptor

System Block Diagram

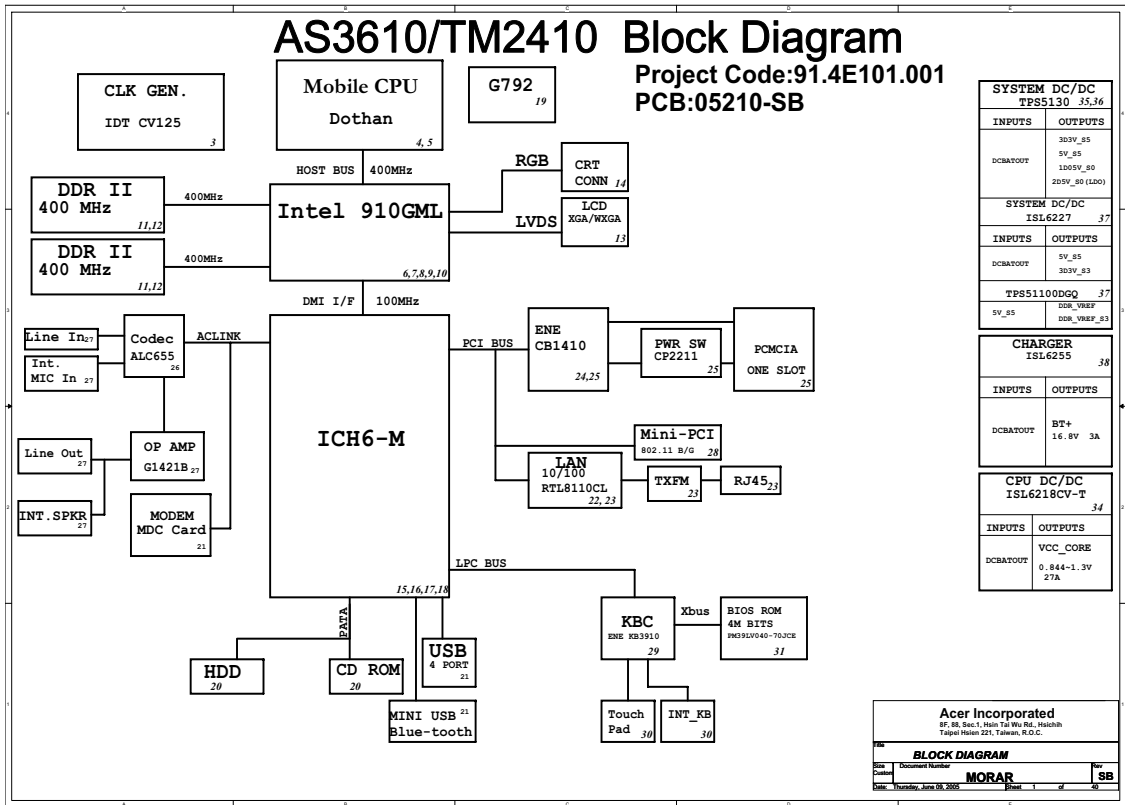

Board Layout

Top View

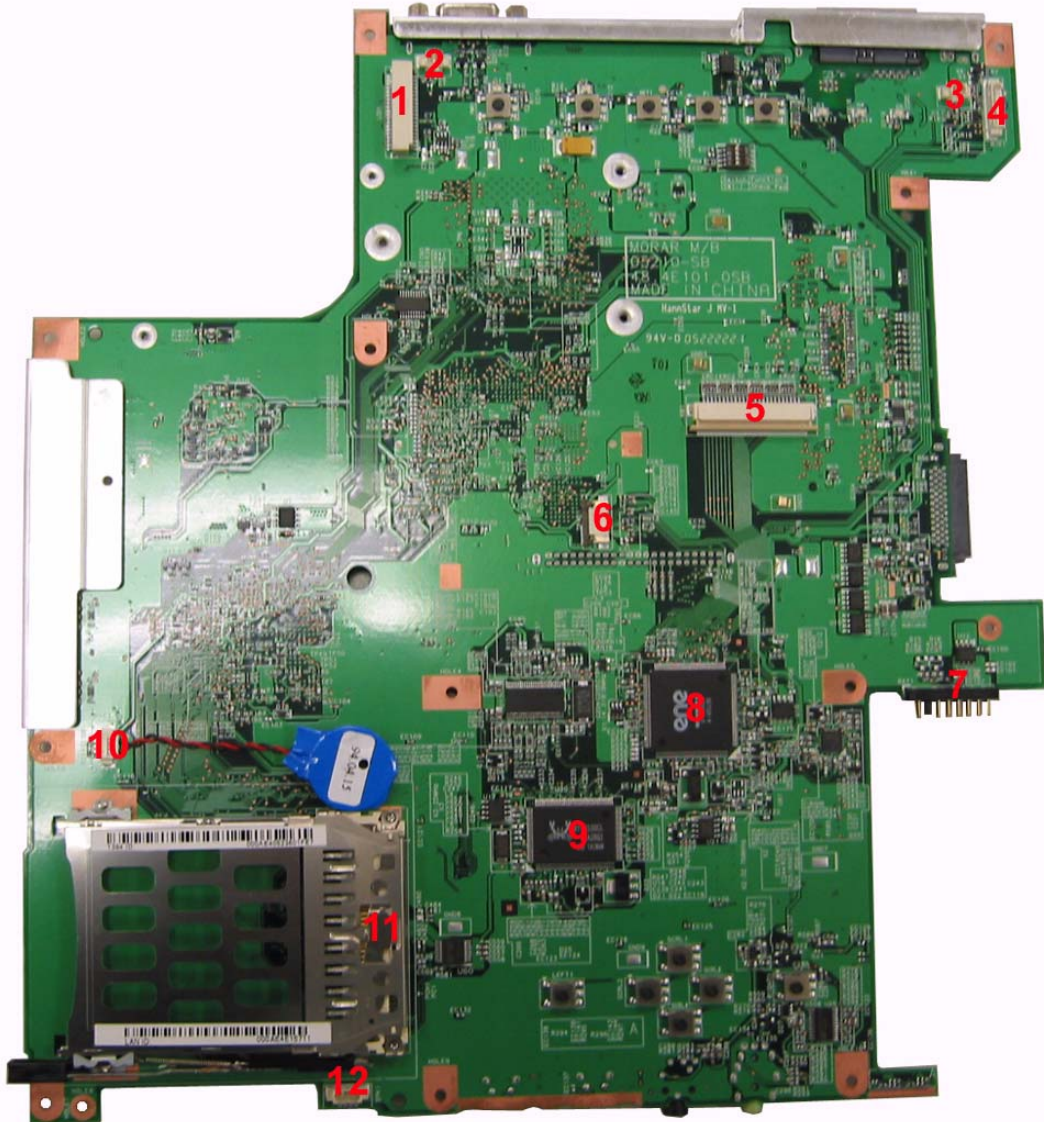

1	LCD1	LCD Cable Connector	7	BAT1	Battery Pack Connector
2	MIC1	Microphone Cable Connector	8	U14	ENE KB3910SF C1
3	LID1	Lid Switch Cable Connector	9	U20	RTL8100CL
4	BLUE1	Bluetooth Cable Connector	10	RTC1	RTC Battery Connector
5	KB1	Keyboard Connector	11	PCH1	PC Card Slot
6	TPAD1	Touchpad FFC Connector	12	SPK1	Speaker Set Connector

Bottom View

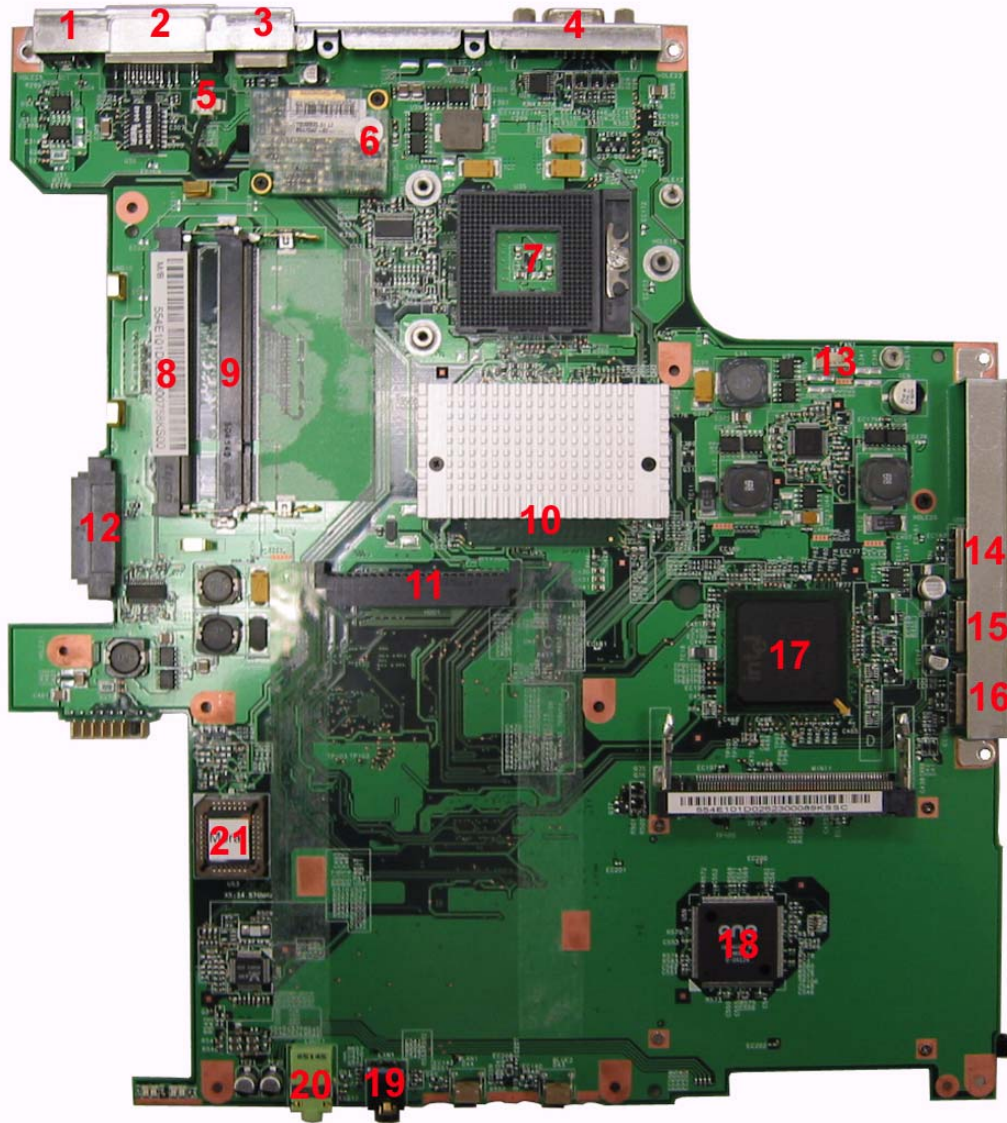

NOTE: This is engineering sample. The image above may not be exactly the same as the real main board you get.

1	DC1	Power Jack	12	ODD1	ODD Connector
2	LAN1	Ethernet Port+Modem Jack	13	FAN1	Fan Connector
3	USB1	USB port	14	USB2	USB Port
4	CRT1	External Display Connector	15	USB3	USB Port
5	MDCW1	Modem Cable Connector	16	USB4	USB Port
6	MDC	Modem Board Connector	17	U49	South Bridge(Intel FW82801FBM F518NC87)

7	U35	CPU Socket	18	U59	ENE CB-1410QF
8	DM2	DIMM Slot1	19	LIN1	Microphone/Line-in Jack
9	DM1	DIMM Slot2	20	LOUT1	Headphones/Speakers/Line-Out Jack
10	U45	North Bridge (Intel 910GML)	21	U53	BIOS ROM
11	HDD	HDD Connector	22		

Jumper Settings

PIN	Description
Pin1-Pin8	Clear Password
Pin2-Pin7	No Function
Pin3-Pin6	No Function
Pin4-Pin5	No Function

An Aspire tour

After knowing your computer features, let us show you around your new TravelMate computer.



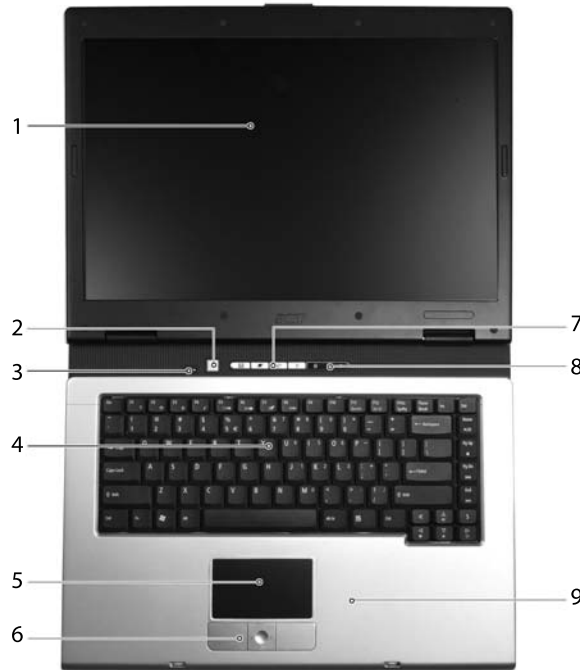



Front View

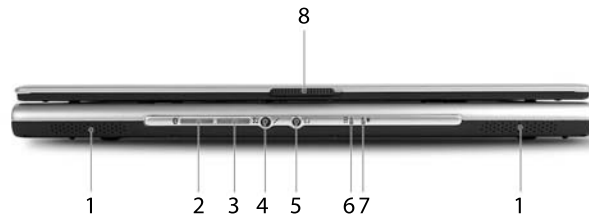

#	Icon	Item	Description
1		Display screen	Also called LCD (liquid-crystal display), displays computer output.
2		Power button	Turns the computer on and off.
3		Microphone	Internal microphone for sound recording.
4		Keyboard	For entering data into your computer.
5		Touchpad	Touch-sensitive pointing device which functions like a computer mouse.
6		Click buttons (left, center and right)	The left and right buttons function like the left and right mouse buttons; the center button serves as a 4-way scroll button.
7		Easy-launch Buttons	Buttons for launching frequently used programs.
8		Status indicators	Light-Emitting Diodes (LEDs) that turn on and off to show the status of the computer's function and components.
9		Palmrest	Comfortable support area for our hands when you use the computer.



Closed Front View

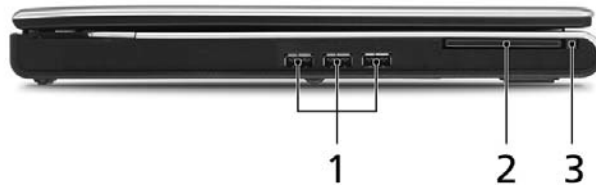

#	Icon	Item	Description
1		Speakers	Left and right speakers deliver stereo audio output.
2		Bluetooth® communication button/indicator	Press to enable/disable Bluetooth function. Lights to indicate the status of Bluetooth-communications (manufacturing option).
3		Wireless communication button/indicator	Press to enable/disable Wireless function. Lights to indicate the status of wireless LAN communications. (manufacturing option).
4		Microphone/Line-in jack	Accepts input from external microphones.
5		Headphones/Speakers/Line-Out jack	Connects to audio line-out devices (e.g., speakers, headphones).
6		Battery indicator	Lights when the battery is being charged
7		Power indicator	Lights when the computer is on.
8		Latch	Locks and releases the lid.

Left View



#	Icon	Item	Description
1		3 USB 2.0 Ports	Connects to USB 2.0 devices (e.g., USB mouse, USB camera).
2		PC Card slot	Accepts Type II PC Card.
3		PC Card slot eject button	Ejects the PC Card for the slot



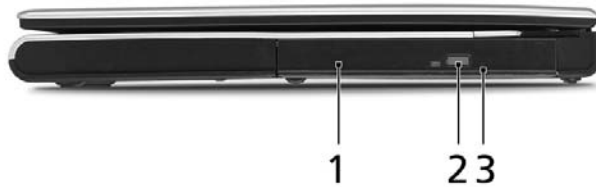



Right View



#	Icon	Item	Description
1		Optical drive	Internal optical drive; accepts CDs or DVDs depending on the optical drive type.
2		Optical drive eject button	Ejects the optical drive tray from the drive.
3		Emergency eject hole	Ejects the optical drive tray when the computer is turned off.

Rear Panel



#	Icon	Item	Description
1		Security Keylock	Connects to a Kensington-compatible computer security lock.
2		Power jack	Connects to an AC adaptor.
3		Ethernet (RJ-45) port	Connects to a Fast Ethernet network.
4		Modem (RJ-11) port	Connects to a phone line.
5		USB 2.0 port	Connects to USB 2.0 devices (e.g., USB mouse, USB camera).
6		External display (VGA) port	Connects a display device (e.g., external monitor, LCD projector).
7		Ventilation slots	Enable the computer to stay cool, even after prolonged use.

Bottom Panel

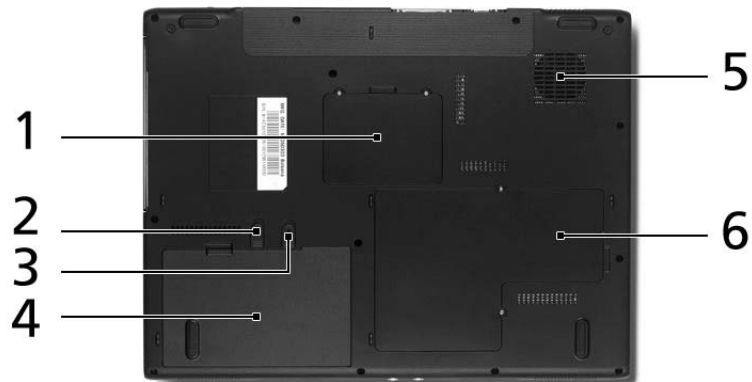







#	Item	Description
1	Memory bay	Houses the computer's main memory.
2	Battery lock	Locks the battery in place.
3	Battery release latch	Releases the battery for removal.
4	Battery bay	Houses the computer's battery pack.
5	Cooling fan	Helps keep the computer cool. Note: Do not cover or obstruct the opening of the fan.
6	Wireless LAN and hard disk bay	Houses the computer's WLAN and hard disk (secured with three screws).

Indicators

The computer has four easy-to-read status indicators on the upper-right above the keyboard, and four on the front panel.



The power, battery and wireless communication status indicators are visible even when the LCD display is closed.

Icon	Function	Description
	Cap lock	Lights when Cap Lock is activated
	Num lock	Lights when Num Lock is activated.
	Media Activity	Indicates when the hard disc or optical drive is active.
	Bluetooth	Indicates the status of Bluetooth communication.
	Wireless LAN	Indicates the status of wireless LAN communication.
	Battery	Lights up when the battery is being charged.
	Power	Lights up when the computer is on.

NOTE: 1. **Charging:** The light shows amber when the battery is charging. 2. **Fully charged:** The light shows green when in AC mode.

Launch Keys

Located at the upper-right, above the keyboard are four buttons. These buttons are called launch keys. The are: mail, Web browser, Acer Empowering key “*e*” and one user-programmable button.

Press “*e*” to run the Acer eManager. Please see “Acer eManager”. The mail and Web buttons are pre-set to email and Internet programs, but can be reset by users. To set the Web browser, mail and programmable keys, run the Acer Launch Manager.



Launch key	Default application
Mail	Email application (user-programmable)
Web browser	Internet browser (user-programmable)
<i>e</i>	Acer eManager (user-programmable)
P	User-programmable

Touchpad

The built-in touchpad is a pointing device that senses movement on its surface. This means the cursor responds as you move your finger across the surface of the touchpad. The central location on the palmrest provides optimum comfort and support.



Touchpad Basics

The following teaches you how to use the touchpad:



- Move your finger across the touchpad (2) to move the cursor.
- Press the left (1) and right (4) buttons located beneath the touchpad to perform selection and execution functions. These two buttons are similar to the left and right buttons on a mouse. Tapping on the touchpad is the same as clicking the left button.
- Use the 4-way scroll (3) button to scroll up or down and move left or right a page. This button mimics your cursor pressing on the right scroll bar of Windows applications.

Function	Left Button (1)	Right Button (4)	Main touchpad (2)	Center button (3)
Execute	Click twice quickly		Tap twice (at the same speed as double-clicking the mouse button)	
Select	Click once		Tap once	
Drag	Click and hold, then use finger to drag the cursor on the touchpad		Tap twice (at the same speed as double-clicking a mouse button) then hold finger to the touchpad on the second tap to drag the cursor.	
Access context menu		Click once		
Scroll				Click and hold to move up/down/left/right.

NOTE: Keep your fingers dry and clean when using the touchpad. Also keep the touchpad dry and clean. The touchpad is sensitive to finger movements. Hence, the lighter the touch, the better the response. Tapping too hard will not increase the touchpad's responsiveness.

Using the Keyboard

The keyboard has full-sized keys and an embedded keypad, separate cursor keys, two Windows keys and twelve function keys.

Lock Keys and embedded numeric keypad

The keyboard has three lock keys which you can toggle on and off.











Lock Key	Description
Caps Lock	When Caps Lock is on, all alphabetic characters typed are in uppercase.
Num lock <Fn>+<F11>	When Num Lock is on, the embedded keypad is in numeric mode. The keys function as a calculator (complete with the arithmetic operators +, -, *, and /). Use this mode when you need to do a lot of numeric data entry. A better solution would be to connect an external keypad.
Scroll lock <Fn>+<F12>	When Scroll Lock is on, the screen moves one line up or down when you press the up or down arrow keys respectively. Scroll Lock does not work with some applications.

The embedded numeric keypad functions like a desktop numeric keypad. It is indicated by small characters located on the upper right corner of the keycaps. To simplify the keyboard legend, cursor-control key symbols are not printed on the keys.

Desired Access	Num Lock On	Num Lock Off
Number keys on embedded keypad	Type numbers in a normal manner.	
Cursor-control keys on embedded keypad	Hold <Shift> while using cursor-control keys.	Hold <Fn> while using cursor-control keys.
Main keyboard keys	Hold <Fn> while typing letters on embedded keypad.	Type the letters in a normal manner.

Windows Keys

The keyboard has two keys that perform Windows-specific functions.



Key	Icon	Description
Windows key 		<p>Pressed alone, this key has the same effect as clicking on the Windows Start button; it launches the Start menu. It can also be used with other keys to provide a variety of function:</p> <ul style="list-style-type: none">  + <Tab> Activates next taskbar button.  + <E> Opens the My Computer window  + <F1> Opens Help and Support.  + <F> Opens the Find: All Files dialog box.  + <R> Opens the Run dialog box.  + M Minimizes all windows. <p><Shift>+  + <M> Undoes the minimize all windows action.</p>
Application key		This key has the same effect as clicking the right mouse button; it opens the application's context menu.













Hot Keys

The computer employs hotkeys or key combinations to access most of the computer's controls like screen brightness, volume output and the BIOS utility.

To activate hot keys, press and hold the <Fn> key before pressing the other key in the hotkey combination.



Hot Key	Icon	Function	Description
Fn-F1		Hot key help	Displays help on hot keys.
Fn-F2		Acer eSetting	Launches the Acer eSettings in Acer eManager.
Fn-F3		Acer ePowerManagement	Launches the Acer ePowerManagement in Acer eManager.

Hot Key	Icon	Function	Description
Fn-F4		Sleep	Puts the computer in Sleep mode.
Fn-F5		Display toggle	Switches display output between the display screen, external monitor (if connected) and both.
Fn-F6		Screen blank	Turns the display screen backlight off to save power. Press any key to return.
Fn-F7		Touchpad toggle	Turns the internal touchpad on and off.
Fn-F8		Speaker toggle	Turns the speakers on and off.
Fn- 		Volume up	Increases the speaker volume.
Fn- 		Volume down	Decreases the speaker volume.
Fn- 		Brightness up	Increases the screen brightness.
Fn- 		Brightness down	Decreases the screen brightness

Special Key

You can locate the Euro symbol and US dollar sign at the upper-center and/or bottom-right of your keyboard. To type:



The Euro symbol

1. Open a text editor or word processor.
2. Either directly press the **<Euro>** symbol at the bottom-right of the keyboard, or hold **<Alt Gr>** and then press the **<5>** symbol at the upper-center of the keyboard.

The US dollar sign

1. Open a text editor or word processor.
2. Either directly press the **<Dollar>** key at the bottom-right of the keyboard, or hold **<Shift>** and then press the **<4>** key at the upper-center of the keyboard.

NOTE: This function varies by the operating system version.

NOTE: Some fonts and software do not support the Euro symbol. Please refer to www.microsoft.com/typography/faq/faq12.htm for more information.

Hardware Specifications and Configurations

Processor

Item	Specification
CPU type	Intel® Pentium® M 725A Processor (2 MB L2 cache, 1.6GHz, 400MHz FSB) Intel® Celeron M 360/370/380 Processor (1 MB L2 cache, 1.40/1.50/1.60GHz, 400MHz FSB)
Core logic	Intel® 910GML+ICH6M
CPU package	Intel socketable 478pin Micro-BGA
CPU core voltage	1.34 (highest frequency mode) to 0.988V (low frequency mode) 0.726V (deeper sleep mode)

BIOS

Item	Specification
BIOS vendor	PhneoiX
BIOS Version	3A03
BIOS ROM type	PMC PM39LV040, 512KX8 CMOS Boot Block Flash Memory
BIOS ROM size	512KB Flash BIOS
BIOS package	32-pin PLCC
Supported protocols	ACPI 1.0b, PC Card 95, SM BIOS 2.3, IEEE1284-ECP/EPP, PCI 2.2, PnP 1.0a, DMI 2.0, PS/2 keyboard and mouse, USB 2.0, VGA BIOS, CD-ROM bootable, IEEE 1394
BIOS password control	Set by setup manual

Second Level Cache

Item	Specification
Cache controller	Built-in CPU
Cache size	2MB for Intel® Pentium® M 725A Processor 1MB for Intel® Celeron M 360/370/380 Processor
1st level cache control	Always enabled
2st level cache control	Always enabled
Cache scheme control	Fixed in write-back

System Memory

Item	Specification
Memory controller	Built-in Intel® 910GML
Memory size	0MB (no on-board memory)
DIMM socket number	2 sockets
Supports memory size per socket	1024MB
Supports maximum memory size	2G (by two 1024MB SO-DIMM module)
Supports DIMM type	DDR 2 Synchronous DRAM
Supports DIMM Speed	400 MHz
Supports DIMM voltage	1.8V and 0.9V
Supports DIMM package	200-pin soDIMM
Memory module combinations	You can install memory modules in any combinations as long as they match the above specifications.

Memory Combinations

Slot 1	Slot 2	Total Memory
0MB	128MB	128MB
0MB	256MB	256MB
0MB	512MB	512MB
0MB	1024MB	1024MB
128MB	128MB	256MB
128MB	256MB	384MB
128MB	512MB	640MB
128MB	1024MB	1152MB
256MB	128MB	384MB
256MB	256MB	512MB
256MB	512MB	768MB
256MB	1024MB	1280MB
512MB	128MB	640MB
512MB	256MB	768MB
512MB	512MB	1024MB
512MB	1024MB	1536MB
1024MB	0MB	1024MB
1024MB	128MB	1152MB
1024MB	256MB	1280MB
1024MB	512MB	1536MB
1024MB	1024MB	2048MB

NOTE: Above table lists some system memory configurations. You may combine DIMMs with various capacities to form other combinations. On above table, the configuration of slot 1 and slot 2 could be reversed.

LAN Interface

Item	Specification
Chipset	Realtek 8110CL
Supports LAN protocol	10/100Mbps
LAN connector type	RJ45
LAN connector location	Rear side
Features	Integrated 10/100 BASE-T transceiver Wake on LAN support compliant with ACPI 2.0 PCI v2.2

Modem Interface

Item	Specification
Data modem data baud rate (bps)	56K
Supports modem protocol	V.92
Modem connector type	RJ11
Modem connector location	Rear side

Bluetooth Interface

Item	Specification
Chipset	Broadcom

Bluetooth Interface

Item	Specification
Data throughput	723 bps (full speed data rate)
Protocol	Bluetooth 1.1 (Upgradeable to Bluetooth 1.2 when SIG specification is ratified).
Interface	USB 1.1
Connector type	Mini-USB

Wireless Module 802.11b/g (optional device)

Item	Specification
Chipset	Atheros/Broadcom
Data throughput	11~54 Mbps
Protocol	802.11b+g
Interface	Mini-PCI type II

Hard Disk Drive Interface

Item			
Vendor & Model Name	HGST HTS424040M9AT00/ Toshiba Pluto MK4025GAS/ Seagate ST94019A	HGST MORAGA IC25N060ATMR04-0 Toshiba Pluto MK6025GAS Seagate 960821A	HGST MORAGA IC25N080ATMR04-0 SEAGATE ST9808210A
Capacity (MB)	40000	60000	80000
Bytes per sector	512	512	512
Data heads	2	3 (for Hitachi and Seagate) 4 (for Toshiba)	4 (for Hitachi) 3 (for Seagate)
Drive Format			
Disks	1	2	2
Spindle speed (RPM)	4200 RPM	4200 RPM	4200 RPM
Performance Specifications			
Buffer size	2048KB	8192KB	8192KB
Interface	ATA/ATAPI-6; ATA-6	ATA/ATAPI-6; ATA-6	ATA/ATA-6; ATA-6
Max. media transfer rate (disk-buffer, Mbytes/s)	372	350	350
Data transfer rate (host~buffer, Mbytes/s)	100 MB/Sec. Ultra DMA mode-5	100 MB/Sec. Ultra DMA mode-5	100 MB/Sec. Ultra DMA mode-5
DC Power Requirements			
Voltage tolerance	5V(DC) +/- 5%	5V(DC) +/- 5%	5V(DC) +/- 5%

Combo Drive Interface

Item	Specification
Vendor & model name	DVD/CDRW KME UIDA760 (24x24x8x24x) DVD/CDRW QSI SBW-242C (24x24x8x24x)

Combo Drive Interface

Item	Specification	
Performance Specification	With CD Diskette	With DVD Diskette
Transfer rate (KB/sec)	Sustained: Max 3.6Mbytes/sec	Sustained: Max 10.8Mbytes/sec
Buffer Memory	2MB	
Interface	Enhanced IDE(ATAPI) compatible	
Applicable disc format	DVD: DVD-ROM, (DVD-5, DVD-9, DVD-10, DVD-18),DVD-R (read, single border), DVD-RW, DVD-RAM (2.6GB, 4.7GB) CD: CD-DA, CD-ROM, CD-ROM XA, CD-R, CD-RW Photo (Multisession) Video CD, CD-Extra, (CD+), CD-test	
Loading mechanism	Load: Manual Release: (a) Electrical Release (Release Button) (b) Release by ATAPI command (c) Emergency Release	
Power Requirement		
Input Voltage	5 V +/- 5 % (Operating)	

DVD-Dual Interface

Item	Specification	
Vendor & model name	DVD Dual HLDS GWA-4040N	
Performance Specification	With CD Diskette	With DVD Diskette
Transfer rate (KB/sec)	Sustained: Max 3.6Mbytes/sec	Sustained: Max 10.8Mbytes/sec
Buffer Memory	2MB	
Interface	Enhanced IDE(ATAPI) compatible	
Applicable disc format	Support disc formats 1. Reads data in each CD-ROM, CD-ROM XA, CD-1, Video CD, CD-Extra and CD-Text 2. Reads data in Photo CD (single and Multi-session) 3. Reads standard CD-DA 4. Reads and writes CD-R discs 5. Reads and writes CD-RW discs 6. Reads and writes in each dVD+R/RW (Ver. 1.1) 7. Reads data in each DVD-ROM and DVD-R (Ver. 2.0 for Authoring) 8. Reads and writes in each DVD-R (Ver. 2.0 for general), DVD-RW and DVD+R/RW (Ver1.1)	
Loading mechanism	Load: Manual Release: (a) Electrical Release (Release Button) (b) Release by ATAPI command (c) Emergency Release	
Power Requirement		
Input Voltage	5 V +/- 5 % (Operating)	

Audio Interface

Item	Specification
Audio Controller	ALC655
Audio onboard or optional	Built-in
Mono or Stereo	Stereo
Resolution	16 bit stereo digital to analog converter 16 bit stereo analog to digital converter

Audio Interface

Item	Specification
Compatibility	AC97
Mixed sound source	Line-in, CD
Voice channel	8/16-bit, mono/stereo
Sampling rate	44,1 KHz (48K byte for AC97 interface)
Internal microphone	Yes
Internal speaker / Quantity	Yes/2

Video Interface

Item	Specification
Chipset	Built-in Intel® 910GML
Package	35.5 mm x 40 mm 1257 pin mBGA
Interface	internal PCIE
Supports ZV (Zoomed Video) port	Yes

Video Memory

Item	Specification
Chipset	Built-in Intel® 910GML
Memory size	64MB/128MB
Interface	DDR2

USB Port

Item	Specification
Chipset	Built-in ICH6-M
USB Compliancy Level	2.0
OHCI	USB 1.1 and USB 2.0 Host controller
Number of USB port	4
Location	three on the left side; one on the rear side
Serial port function control	Enable/Disable by BIOS Setup

PCMCIA Port

Item	Specification
PCMCIA controller	ENE CB1410
Supports card type	Type-II
Number of slots	One type-II
Access location	Left panel
Supports ZV (Zoomed Video) port	No ZV support
Supports 32 bit CardBus	Yes

System Board Major Chips

Item	Controller
Core logic	Intel® 910GML+ICH6-M

System Board Major Chips

Item	Controller
VGA	Built in Intel®910GML
LAN	RealTek 8110CL
USB 2.0	Built in ICH6-M
Super I/O controller	This model does not employ Super I/O controller since it does not have FIR, IEEE 1394 function
MODEM	Built-in ICH6-M
Bluetooth	Broadcom
Wireless 802.11 b+g	Atheros/Broadcom
PCMCIA	ENE CB1410
Audio	ALC655

Keyboard

Item	Specification
Keyboard controller	KB 3910
Total number of keypads	88-/89-key
Windows logo key	Yes
Internal & external keyboard work simultaneously	Plug USB keyboard to the USB port directly: Yes

Battery

Item	Specification
Vendor & model name	Sanyo 4UR18650F-2-QC140 Panasonic CGR-B/8B5AE
Battery Type	Li-ion
Pack capacity	4400 mAh for 8cell; 4000mAh for 4cell
Number of battery cell	8/4
Package configuration	4 cells in series, 2 series in parallel
Normal voltage	14.4V
Charge voltage	16.8+-0.2v

LCD 15 inch

Item	Specification		
Vendor & model name	AU: B150XG01	QDI QD15XL06-01	Hannstar HSD150PX14-A07
Screen Diagonal (mm)	381	15.0 inches	15.0 inches
Active Area (mm)	304.1x228.1	304.1x228.1	304.1x228.1
Display resolution (pixels)	1024x768 XGA	1024x768 XGA	1024x768 XGA
Pixel Pitch	0.297x0.297	0.099x0.297	0.297x0.297
Pixel Arrangement	R.G.B. Vertical Stripe	R.G.B. Vertical Stripe	R.G.B. Vertical Stripe
Display Mode	Normally White	Normally White	Normally White

LCD 15 inch

Item	Specification		
Typical White Luminance (cd/m ²) also called Brightness	180 (5 point average) 150 (5 point average)	160	150
Luminance Uniformity	N/A	N/A	70
Contrast Ratio	300	300	250
Response Time (Optical Rise Time/Fall Time)msec	24/11 15/35	8/17	10/25
Nominal Input Voltage VDD	+3.3V Typ.	+3.3V	3.3V
Typical Power Consumption (watt)	5.6/5.7	3.96	N/A
Weight	550	570	600
Physical Size(mm)	317.3x242.0x6.0	317.3x242.0x5.9	317.3x242.0x6.5
Electrical Interface	1 channel LVDS	1 channel LVDS	1 channel LVDS
Support Color	262K colors (RGB 6-bit data driver)	262,144	262,144
Viewing Angle (degree) Horizontal: Right/Left Vertical: Upper/Lower	40/40 10/30	45/45 15/35	40/40 20/40
Temperature Range(° C) Operating Storage (shipping)	0 to +50 -20 to +60	0 to +50 -25 to +60	0 to +50 -20 to +60

LCD 15 inch and 15.4 inch

Item	Specification		
Vendor & model name	LG LP150X08-A3	LG LP154W01-A5K2	CHIMEI N154I1-L07
Screen Diagonal (mm)	15.0 inches, 38.1cm	15.4 inches	390.1
Active Area (mm)	304.1x228.1	331.2x207.0	331.2x207.0
Display resolution (pixels)	1024x768 XGA	1280x800 WXGA	1280x800 WXGA
Pixel Pitch	0.297x0.297	0.25875x0.25875	0.25875x0.25875
Pixel Arrangement	R.G.B. Vertical Stripe	R.G.B. Vertical Stripe	R.G.B. Vertical Stripe
Display Mode	Transmissive mode, normally White	Transmissive & normally White	Normally White
Typical White Luminance (cd/m ²) also called Brightness	150	150	190
Luminance Uniformity	N/A	40	N/A
Contrast Ratio	250	300	500
Response Time (Optical Rise Time/Fall Time)msec	10/20(typ)	30/30	10/20
Nominal Input Voltage VDD	+3.3V	+3.3V	+3.3V Typ.
Typical Power Consumption (watt)	4.3 for backlight unit only	5.36	4.22 for backlight unit
Weight	540	585	625
Physical Size(mm)	317.3x242.1x6.0	344x222.0x6.35 max	344x222.0x6.35 max
Electrical Interface	1 channel LVDS	1 channel LVDS	1 channel LVDS

LCD 15 inch and 15.4 inch

Item	Specification		
Support Color	262K	262K	262K colors (RGB 6-bit data driver)
Viewing Angle (degree) Horizontal: Right/Left Vertical: Upper/Lower	45/45 15/35	45/45 15/35	45/45 15/35
Temperature Range(° C) Operating Storage (shipping)	0 to +50 -20 to +60	0 to +50 -20 to +60	0 to +50 -20 to +60

LCD Inverter

Item	Specification
Vendor & model name	Darfon/V189-301GP
Brightness conditions	N/A
Input voltage (V)	9~21
Input current (mA)	2.56 (max)
Output voltage (V, rms)	780V (2000V for kick off)
Output current (mA, rms)	6.5 (max)
Output voltage frequency (k Hz)	65K Hz (max)

AC Adaptor

Item	Specification
Input rating	90V AC to 264V AC, 47Hz to 63Hz
Maximum input AC current	1.7A
Inrush current	220A@115VAC 220A@230VAC
Efficiency	82% min. @115VAC input full load

System Power Management

ACPI mode	Power Management
Mech. Off (G3)	All devices in the system are turned off completely.
Soft Off (G2/S5)	OS initiated shutdown. All devices in the system are turned off completely.
Working (G0/S0)	Individual devices such as the CPU and hard disc may be power managed in this state.
Suspend to RAM (S3)	CPU set power down VGA Suspend PCMCIA Suspend Audio Power Down Hard Disk Power Down CD-ROM Power Down Super I/O Low Power mode
Save to Disk (S4)	Also called Hibernation Mode. System saves all system states and data onto the disc prior to power off the whole system.

System Utilities

BIOS Setup Utility

The BIOS Setup Utility is a hardware configuration program built into your computer's BIOS (Basic Input/Output System).

Your computer is already properly configured and optimized, and you do not need to run this utility. However, if you encounter configuration problems, you may need to run Setup. Please also refer to Chapter 4 Troubleshooting when problem arises.

To activate the BIOS Utility, press **F2** during POST (when "Press <F2> to enter Setup" message is prompted on the bottom of screen).

Press **F2** to enter setup. The default parameter of F12 Boot Menu is set to "disabled". If you want to change boot device without entering BIOS Setup Utility, please set the parameter to "enabled".

Press <F12> during POST to enter multi-boot menu. In this menu, user can change boot device without entering BIOS SETUP Utility.

PhoenixBIOS Setup Utility			
Information	Main	Security	Boot Exit
CPU Type :	Intel (R) Pentium (R) M processor 1.86GHz		
CPU Speed :	1866MHz		
IDE1 Model Name :	TOSHIBA MK8025GAS - (PM)		
IDE1 Serial Number :	None		
IDE2 Model Name :	PIONEER DVD-RW DVR-K15RA - (PS)		
IDE2 Serial Number :	None		
System BIOS Ver:	V0.06A		
VGA BIOS Ver	1277		
KBC Ver	07.07		
Serial Number	xxxxxxxxxxxxxxxxxxxxxxxxxxxx		
Asset Tag Number	N/A		22 Byte
Produce Name	Aspire 3610		32 Byte
Manufacturer Name:	Acer		16 Byte
UUID:	xxxxxxxxxxxxxxxxxxxxxxxxxxxx		16 Byte
			32 Byte
F1 Help	↑↓ Select Item	F5/F6 Change Values	F9 Setup Defaults
Esc Exit	←→ Select Menu	Enter Select ▶ Sub-Menu	F10 Save and Exit

Navigating the BIOS Utility

There are six menu options: Info., Main, System Devices, Security, Boot, and Exit.

Follow these instructions:

- ❑ To choose a menu, use the cursor left/right keys (← →).
- ❑ To choose a parameter, use the cursor up/down keys (↑ ↓).
- ❑ To change the value of a parameter, press F8 or F6.
- ❑ A plus sign (+) indicates the item has sub-items. Press ENTER to expand this item.
- ❑ Press ESC while you are in any of the menu options to go to the Exit menu.
- ❑ In any menu, you can load default settings by pressing F8. You can also press F6 to save any changes made and exit the BIOS Setup Utility.

NOTE: You can change the value of a parameter if it is enclosed in square brackets. Navigation keys for a particular menu are shown on the bottom of the screen. Help for parameters are found in the Item Specific Help part of the screen. Read this carefully when making changes to parameter values. **Please note that system information is subject to different models.**

Information

PhoenixBIOS Setup Utility

Information
Main
Security
Boot
Exit

```

CPU Type :           Intel (R) Pentium (R) M processor   1.86GHz
CPU Speed :          1866MHz
IDE1 Model Name :    TOSHIBA MK8025GAS - (PM)
IDE1 Serial Number : None
IDE2 Model Name :    PIONEER DVD-RW DVR-K15RA - (PS)
IDE2 Serial Number : None
System BIOS Ver:    V0.06A
VGA BIOS Ver        1277
KBC Ver             07.07
Serial Number       xxxxxxxxxxxxxxxxxxxxxxxxx
Asset Tag Number    N/A                               22 Byte
Produce Name        Aspire 3610                       32 Byte
Manufacturer Name:  Acer                               16 Byte
UUID:              xxxxxxxxxxxxxxxxxxxxxxxxx          16 Byte
                                                           32 Byte
                
```

F1 Help
↑↓ Select Item
F5/F6 Change Values
F9 Setup Defaults
Esc Exit
←→ Select Menu
Enter Select ▶ Sub-Menu
F10 Save and Exit

NOTE: The system information is subject to different models.

Parameter	Description
CPU Type	This field shows the CPU type and speed of the system.
IDE1 Model Name	This field shows the model name of HDD installed on primary IDE master.
IDE1 Serial Number	This field displays the serial number of HDD installed on primary IDE master.
IDE2 Model Name	This field displays the model name of devices installed on secondary IDE master. The hard disk drive or optical drive model name is automatically detected by the system.
IDE2 Serial Number	This field shows the serial number of devices installed on secondary IDE master.
System BIOS ver	Displays system BIOS version.
VGA BIOS Ver	This field displays the VGA firmware version of the system.
KBC Ver	This field shows the keyboard
Serial Number	This field displays the serial number of this unit.
Asset Tag Number	This field displays the asset tag number of the system.
Product Name	This field shows product name of the system.
Manufacturer Name	This field displays the manufacturer of this system.
UUID Number	This will be visible only when an internal LAN device is presenting. UUID=32bytes

Main

The Main screen displays a summary of your computer hardware information, and also includes basic setup parameters. It allows the user to specify standard IBM PC AT system parameters.

PhoenixBIOS Setup Utility			
Information	Main	Security	Boot Exit
			Item Specific Help
System Time:	[09:25:48]		
System Date:	[07/08/2005]		
System Memory:	640 KB	Shows system base memory size	
Extended Memory:	510 MB	Shows extended memory size	
Video Memory	[128MB]	VGA memory size	
Quiet Boot:	[Enabled]		
Power on display:	[Auto]		
Network boot	[Enabled]		
F12 Boot Menu	[Disabled]		
D2D Recovery	[Enabled]		
<Tab>, <Shift-Tab>, or <Enter> selects field.			
F1 Help	↑↓ Select Item	F5/F6 Change Values	F9 Setup Defaults
Esc Exit	←→ Select Menu	Enter Select ▶ Sub-Menu	F10 Save and Exit

NOTE: The screen above is for your reference only. Actual values may differ.

The table below describes the parameters in this screen. Settings in **boldface** are the default and suggested parameter settings.

Parameter	Description	Format/Option
System Time	Sets the system time. The hours are displayed with 24-hour format.	Format: HH:MM:SS (hour:minute:second) System Time
System Date	Sets the system date.	Format MM/DD/YYYY (month/day/year) System Date
System Memory	This field reports the memory size of the system. Memory size is fixed to 640MB	
Extended Memory	This field reports the memory size of the extended memory in the system. Extended Memory size=Total memory size-1MB	
VGA Memory	Shows the VGA memory size. VGA Memory size=64/128MB	
Quiet Boot	Determines if Customer Logo will be displayed or not; shows Summary Screen is disabled or enabled. Enabled: Customer Logo is displayed, and Summary Screen is disabled. Disabled: Customer Logo is not displayed, and Summary Screen is enabled.	Option: Enabled or Disabled
Power on display	Auto: During power process, the system will detect if any display device is connected on external video port. If any external display device is connected, the power on display will be in CRT (or projector) only mode. Otherwise it will be in LCD only mode. Both: Simultaneously enable both the integrated LCD screen and the system's external video port (for an external CRT or projector).	Option: Auto or Both
Network Boot	Enables, disables the system boot from LAN (remote server).	Option: Enabled or Disabled
F12 Boot Menu	Enables, disables Boot Menu during POST.	Option: Disabled or Enabled
D2D Recovery	Enables, disables D2D Recovery function. The function allows the user to create a hidden partition on hard disc drive to store operation system and restore the system to factory defaults.	Option: Enabled or Disabled

NOTE: The sub-items under each device will not be shown if the device control is set to disable or auto. This is because the user is not allowed to control the settings in these cases.

Security

The Security screen contains parameters that help safeguard and protect your computer from unauthorized use.

PhoenixBIOS Setup Utility			
Information	Main	Security	Boot Exit
User Password is : Clear Supervisor Password is : Clear			Item Specific Help Supervisor Password controls accesses of the whole setup utility. It can be used to boot up when Password on boot is enabled.
Set User Password [Enter] Set Supervisor Password [Enter]			
Primary HardDisk Security [Disabled]			
Password on Boot [Disabled]			
F1 Help	↑ ↓ Select Item	F5/F6 Change Values	F9 Setup Defaults
Esc Exit	← → Select Menu	Enter Select ▶ Sub-Menu	F10 Save and Exit

The table below describes the parameters in this screen. Settings in **boldface** are the default and suggested parameter settings.

Parameter	Description	Option
User Password is	Shows the setting of the user password.	Clear or Set
Supervisor Password is	Shows the setting of the Supervisor password	Clear or Set
Set User Password	Press Enter to set the user password. When user password is set, this password protects the BIOS Setup Utility from unauthorized access. The user can enter Setup menu only and does not have right to change the value of parameters.	
Set Supervisor Password	Press Enter to set the supervisor password. When set, this password protects the BIOS Setup Utility from unauthorized access. The user can not either enter the Setup menu nor change the value of parameters.	
Primary HardDisk Security	Enables or disables primary hard disk security function.	
Password on Boot	Defines whether a password is required or not while the events defined in this group happened. The following sub-options are all requires the Supervisor password for changes and should be grayed out if the user password was used to enter setup.	Disabled or Enabled

NOTE: When you are prompted to enter a password, you have three tries before the system halts. Don't forget your password. If you forget your password, you may have to return your notebook computer to your dealer to reset it.

Setting a Password

Follow these steps as you set the user or the supervisor password:

1. Use the **↑** and **↓** keys to highlight the Set Supervisor Password parameter and press the **ENTER** key. The Set Supervisor Password box appears:

Set Supervisor Password

Enter New Password []

Confirm New Password []

2. Type a password in the "Enter New Password" field. The password length can not exceeds 8 alphanumeric characters (A-Z, a-z, 0-9, not case sensitive). Retype the password in the "Confirm New Password" field.

IMPORTANT: Be very careful when typing your password because the characters do not appear on the screen.

3. Press **ENTER**.
4. After setting the password, the computer sets the User Password parameter to "Set".
4. If desired, you can opt to enable the Password on boot parameter.
5. When you are done, press **F10** to save the changes and exit the BIOS Setup Utility.

Removing a Password

Follow these steps:

1. Use the **↑** and **↓** keys to highlight the Set Supervisor Password parameter and press the **ENTER** key. The Set Password box appears:

Set Supervisor Password		
Enter current password	[]
Enter New Password	[]
Confirm New Password	[]

2. Type the current password in the Enter Current Password field and press **ENTER**.
3. Press **ENTER** twice **without** typing anything in the Enter New Password and Confirm New Password fields. The computer then sets the Supervisor Password parameter to "Clear".
4. When you have changed the settings, press **F10** to save the changes and exit the BIOS Setup Utility.

Changing a Password

1. Use the **↑** and **↓** keys to highlight the Set Supervisor Password parameter and press the **ENTER** key. The Set Password box appears:

Set Supervisor Password		
Enter current password	[]
Enter New Password	[]
Confirm New Password	[]

2. Type the current password in the Enter Current Password field and press **ENTER**.
3. Type a password in the Enter New Password field. Retype the password in the Confirm New Password field.
4. Press **ENTER**. After setting the password, the computer sets the User Password parameter to "Set".
5. If desired, you can enable the Password on boot parameter.
6. When you are done, press **F10** to save the changes and exit the BIOS Setup Utility.

If the verification is OK, the screen will display as following.

Setup Notice
Changes have been saved.
[continue]

The password setting is complete after the user presses **F10**.

If the current password entered does not match the actual current password, the screen will show you the Setup Warning.

Setup Warning
Invalid password
Re-enter Password
[continue]

If the new password and confirm new password strings do not match, the screen will display the following message.

Setup Warning
Password do not match
Re-enter Password

Boot

This menu allows the user to decide the order of boot devices to load the operating system. Bootable devices includes the distette drive in module bay, the onboard hard disk drive and the CD-ROM in module bay.

PhoenixBIOS Setup Utility				
Information	Main	Security	Boot	Exit
+Hard Drive Floppy Devices CD-ROM/DVD Drive Network Boot			Item Specific Help	
			Keys used to view or configure devices: <Enter> to expands or collapses devices with a + or - <F5> and <F6> moves the device up or down.	
F1 Help	↑↓ Select Item	F5/F6 Change Values	F9 Setup Defaults	
Esc Exit	←→ Select Menu	Enter Select ▶ Sub-Menu	F10 Save and Exit	

Exit

The Exit screen contains parameters that help safeguard and protect your computer from unauthorized use.

The screenshot shows the PhoenixBIOS Setup Utility interface. At the top, there is a blue header with the text "PhoenixBIOS Setup Utility". Below this is a dark blue navigation bar with tabs for "Information", "Main", "Security", "Boot", and "Exit". The "Exit" tab is currently selected. The main area is divided into two columns. The left column contains a list of options: "Exit Saving Changes", "Exit Discarding Changes", "Load Setup Defaults", "Discard Changes", and "Save Changes". The right column is titled "Item Specific Help" and contains the text "Exit System Setup and save your changes to CMOS." At the bottom of the screen, there is a blue bar with keyboard shortcuts: "F1 Help", "Esc Exit", "↑↓ Select Item", "←→ Select Menu", "F5/F6 Change Values", "Enter Select", "▶ Sub-Menu", "F9 Setup Defaults", and "F10 Save and Exit".

The table below describes the parameters in this screen.

Parameter	Description
Exit Saving Changes	Exit System Setup and save your changes to CMOS.
Exit Discarding Changes	Exit utility without saving setup data to CMOS.
Load Setup Default	Load default values for all SETUP item.
Discard Changes	Load previous values from CMOS for all SETUP items.
Save Changes	Save Setup Data to CMOS.

BIOS Flash Utility

The BIOS flash memory update is required for the following conditions:

- New versions of system programs
- New features or options
- Restore a BIOS when it becomes corrupted.

Use the Phlash utility to update the system BIOS flash ROM.

NOTE: If you do not have a crisis recovery diskette at hand, then you should create a **Crisis Recovery Diskette** before you use the Phlash utility.

NOTE: Do not install memory-related drivers (XMS, EMS, DPMS) when you use the Phlash.

NOTE: Please use the AC adaptor power supply when you run the Phlash utility. If the battery pack does not contain enough power to finish BIOS flash, you may not boot the system because the BIOS is not completely loaded.

Follow the steps below to run the Phlash.

1. Prepare a bootable diskette.
2. Copy the flash utilities to the bootable diskette.
3. Then boot the system from the bootable diskette. The flash utility has auto-execution function.

Machine Disassembly and Replacement

This chapter contains step-by-step procedures on how to disassemble the notebook computer for maintenance and troubleshooting.

To disassemble the computer, you need the following tools:

- Wrist grounding strap and conductive mat for preventing electrostatic discharge
- Small Philips screw driver
- Philips screwdriver
- Plastic flat head screw driver
- Tweezers

NOTE: The screws for the different components vary in size. During the disassembly process, group the screws with the corresponding components to avoid mismatch when putting back the components. When you remove the stripe cover, please be careful not to scrape the cover.

General Information

Before You Begin

Before proceeding with the disassembly procedure, make sure that you do the following:

1. Turn off the power to the system and all peripherals.
2. Unplug the AC adapter and all power and signal cables from the system.
3. Remove the battery pack.

Disassembly Procedure Flowchart

The flowchart on the succeeding page gives you a graphic representation on the entire disassembly sequence and instructs you on the components that need to be removed during servicing. For example, if you want to remove the system board, you must first remove the keyboard, then disassemble the inside assembly frame in that order.

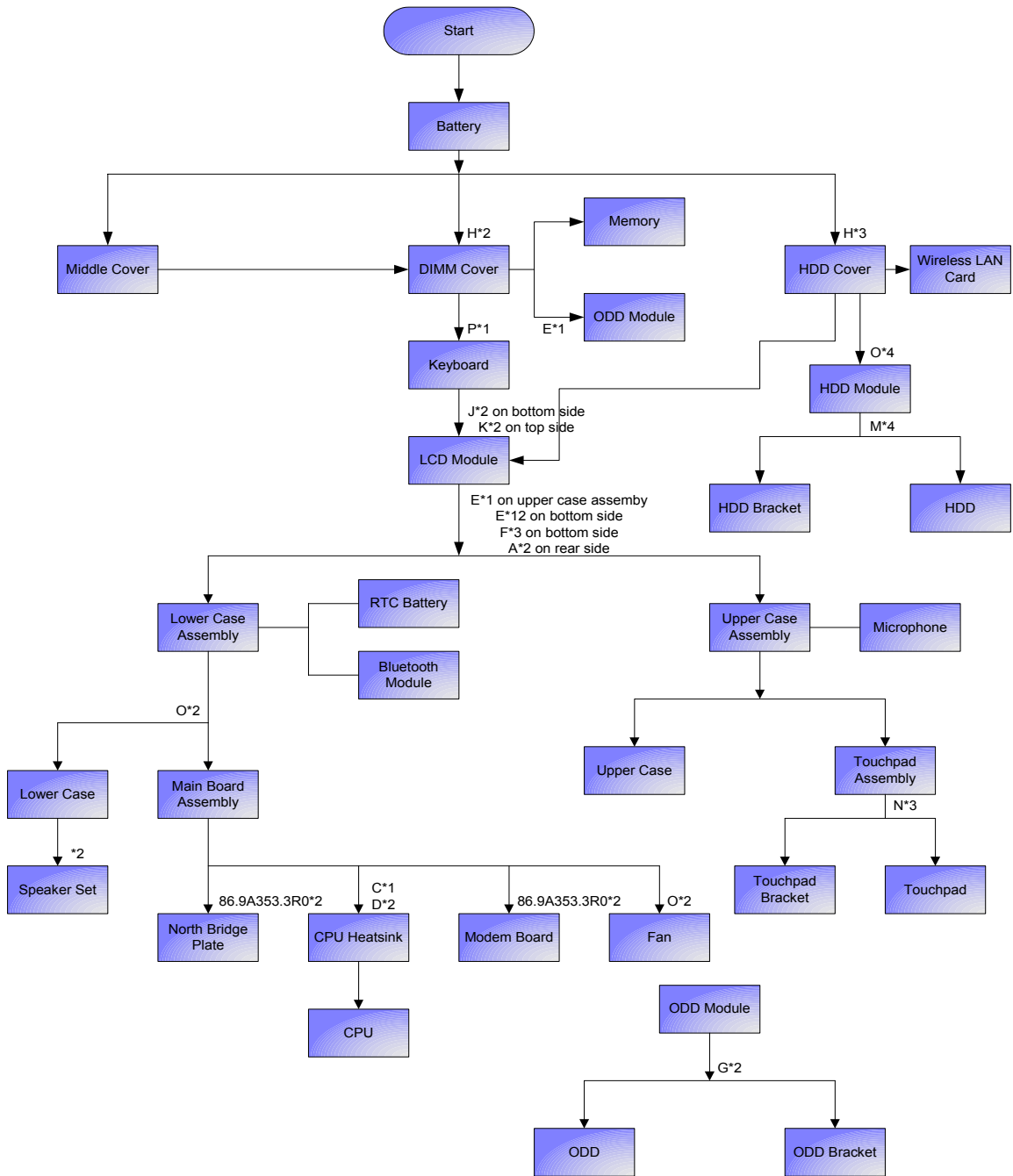

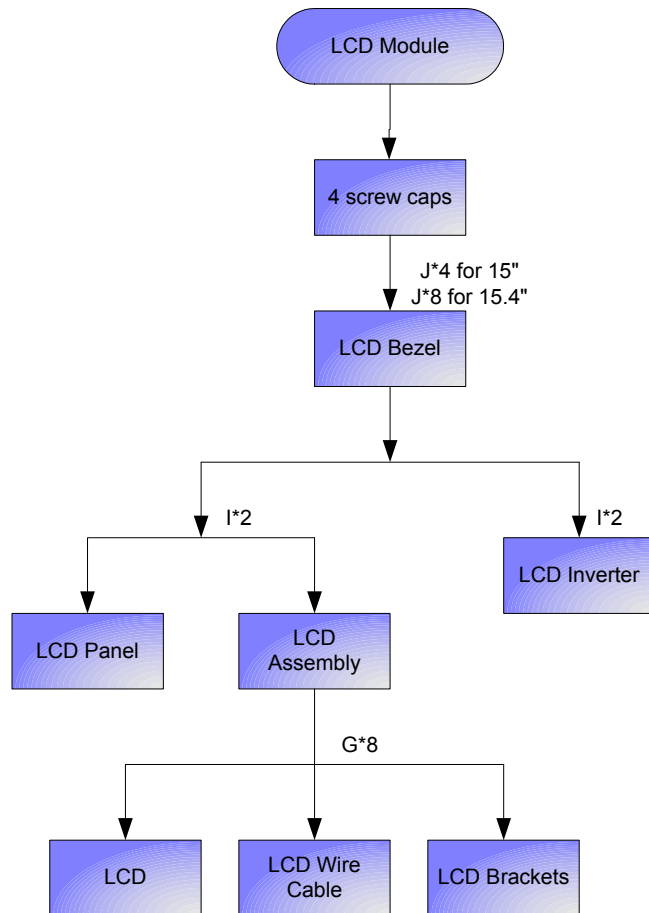

Screw List

Item	Description	Part Number
A	SCW HEX NYL I#R-40/O#4-40 L5.5	34.00015.081
B	SCREW MACH WAFER M2*L4 NI	86.00059.220 (PC Card slot x4)
C	CPU SCREW M2.5*4.3L (2.3 KG)	86.00D01.230
D	CPU SCREW M2.5*4.3L (1.55 KG)	86.00D02.230
E	SCREW M2.5-6	86.9A323.6R0
F	SCRW M2.5*L8(NON NYLOK)	86.9A323.8R0
G	SCREW M2*3 NYLON 1JMCPC-420325	86.9A352.3R0
H	SCREW	86.9A352.4R0
I	SCREW M2.5*4L(NYLOCK)BLACK ZN	86.9A353.4R0
J	SCREW M2.5X6	86.9A353.6R0
K	SRW M2.5*8L B/ZN NYLOK 700	86.9A353.8R0
L	SCRW M2.5*L3(NON NYLOK)	86.9A523.3R0
M	SCREW M3x4(86.9A524.4R0)	86.9A524.4R0
N	SCREW WAFER NYLOK NI 2ML3	86.9A552.3R0
O	SCRW M2*4 WAFER NI	86.9A552.4R0
P	SCRW M2.5*3 WAFER NI	86.9A553.3R0

Removing the Battery Pack

1. Unlock the battery lock.
2. Slide the battery latch then remove the battery.



Removing the Wireless LAN Card/the HDD Module/the Memory/the ODD Module and the LCD Module

Removing the Memory and the HDD Module

1. Remove the three screws fastening the HDD cover.
2. Detach the HDD cover carefully.



3. Disconnect the wireless antenna.
4. Pop out the wireless LAN card then remove it. (Note: This engineering sample does not have wireless LAN card. Therefore, the image does not show wireless LAN antenna/wireless LAN card. Please refer to below section "How to Remove the Wireless LAN Card for more details).
5. Remove four screws fastening the HDD module.
6. Pull the HDD module backwards then detach it.

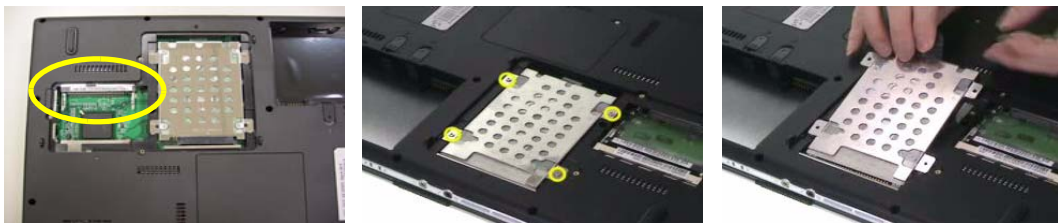

How to Remove the Wireless LAN Card

1. Disconnect the main and the auxiliary antennae.
2. Pop out the wireless LAN card then remove it.

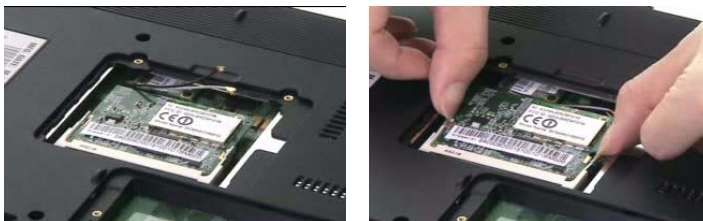

Removing the Memory

1. Remove the two screws fastening the DIMM cover.
2. Then detach the DIMM cover.



3. Pop out the memory.
4. Remove the memory from the DIMM socket.



Removing the ODD Module

1. Remove the screws fastening the ODD module as shown.
2. Use a flat headed screwdriver to push the ODD module outwards then remove it.



Removing the LCD Module

1. Open the notebook as the impage shows.
2. Detach the middle cover carefully as shown.



3. Remove the screw holding the keyboard.
4. Turn over the keyboard as shown.
5. Disconnect the keyboard cable then remove the keyboard.



6. Pull out the wireless LAN antenna from the main unit as shown.
7. Take out the LCD cable from the main unit then disconnect the cable.

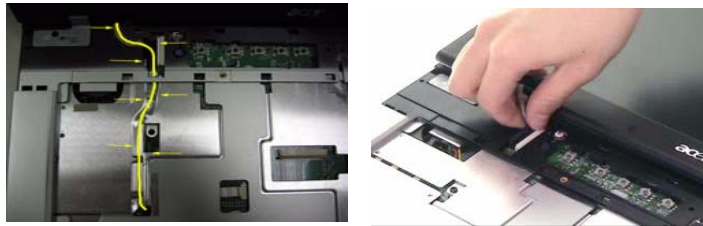

8. Remove two screws fastening the LCD module.
9. Remove another two screws on the bottom as shown.
10. Then detach the entire LCD module cautiously.



Disassembling the Main Unit

Separate the Main Unit Into the Upper and the Lower Case Assembly

1. Disconnect the touchpad cable from the main board.
2. Disconnect the microphone cable then remove the microphone.



3. Remove one screw holding the upper case and the lower case assembly.
4. Then remove 13 screws on the bottom as shown.

NOTE: Screw type for red circle is M2.5x8; and screw type for yellow circle is M2.5x6.



5. Open the upper case assembly as shown.
6. After you open the upper case assembly, please disconnect the lid switch cable.
7. Raise upright the upper case assembly as shown then detach it.



Disassembling the Upper Case Assembly

1. Disconnect the touchpad FFC.
2. Remove the three screws fastening the touchpad bracket.

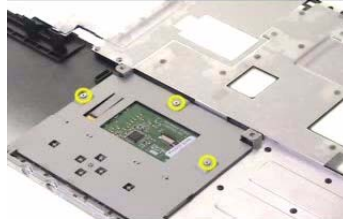

3. Detach the touchpad bracket carefully.
4. Then detach the touchpad from the touchpad bracket.



Disassembling the Lower Case Assembly

1. Disconnect the bluetooth cable then remove the bluetooth module.
2. Disconnect the speaker set cable from the main board.
3. Remove two screws fastening the main board to the lower case.



4. Remove two hex screws holding the main board on the rear side.
5. Then take out the main board from the lower case carefully.



6. Disconnect the fan cable.
7. Remove two screw that hold the system fan then remove it.

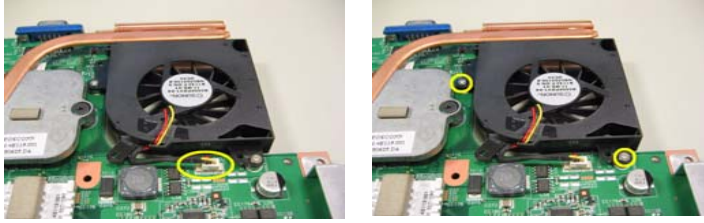

8. Disconnect the modem board cable from the main board.
9. Remove the two screws holding the modem board then detach the modem board.



10. Disconnect the modem cable from the modem board.
11. Remove the three screws holding the CPU heatsink then remove it.

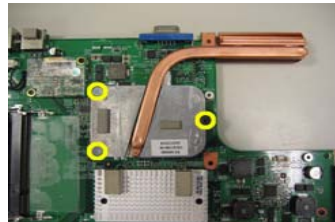

12. Use a flat headed screwdriver to release the CPU socket lock (see two pictures below).

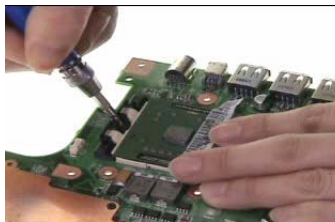
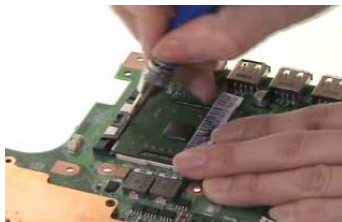

13. Remove the CPU from the socket carefully.
14. Remove the two screws fastening north bridge plate then remove it.

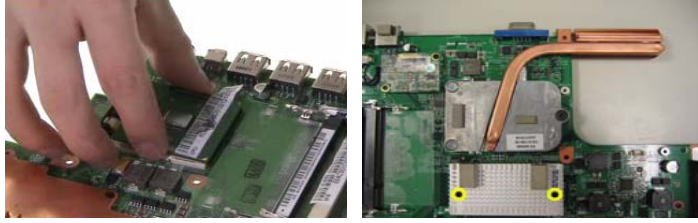

15. Remove the three screws fastening the speaker set.
16. Tear off the tape holding the speaker set.
17. Take out the speaker set from the lower case. This completes main unit disassembly.



Disassembling the LCD Module

1. Remove the four screw caps as shown.
2. Remove the four screws holding the LCD bezel.
3. Then detach the LCD bezel from the LCD module.



4. Remove the two screws fastening the LCD inverter.
5. Take out the LCD inverter from the LCD cover, then disconnect the LCD cable from the inverter.
6. Disconnect the inverter cable and remove the inverter.



7. Remove two screws fastening the LCD assembly.
8. Take out the LCD assembly from Remove another screw holding the LCD bracket on the other side.
9. Remove the four screws fastening the LCD left bracket then remove it.



10. Remove the four screws fastening the LCD right bracket then remove the bracket.
11. Disconnect the LCD cable from the LCD then remove the cable.

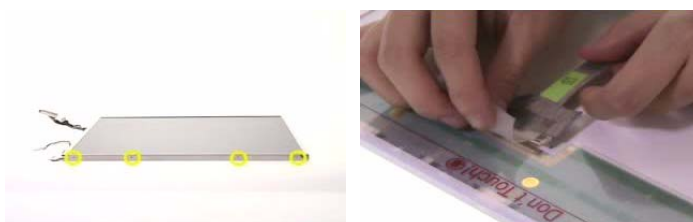

Disassembling the External Modules

Disassembling the HDD Module

1. Remove the two screws holding the HDD bracket on one side.
2. Remove another two screws holding the HDD bracket on the other side.
3. Then take the hard disc drive out from the HDD bracket.



Troubleshooting

Use the following procedure as a guide for computer problems.

NOTE: The diagnostic tests are intended to test only Acer products. Non-Acer products, prototype cards, or modified options can give false errors and invalid system responses.

1. Obtain the failing symptoms in as much detail as possible.
2. Verify the symptoms by attempting to re-create the failure by running the diagnostic test or by repeating the same operation.
3. Use the following table with the verified symptom to determine which page to go to.

Symptoms (Verified)	Go To
Power failure. (The power indicator does not go on or stay on.)	"Power System Check" on page 57.
POST does not complete. No beep or error codes are indicated.	"Power-On Self-Test (POST) Error Message" on page 60 "Undetermined Problems" on page 72
POST detects an error and displayed messages on screen.	"Error Message List" on page 61
Other symptoms (i.e. LCD display problems or others).	"Power-On Self-Test (POST) Error Message" on page 60
Symptoms cannot be re-created (intermittent problems).	Use the customer-reported symptoms and go to "Power-On Self-Test (POST) Error Message" on page 60 "Intermittent Problems" on page 71 "Undetermined Problems" on page 72

System Check Procedures

External Diskette Drive Check

Do the following to isolate the problem to a controller, driver, or diskette. A write-enabled, diagnostic diskette is required.

NOTE: Make sure that the diskette does not have more than one label attached to it. Multiple labels can cause damage to the drive or cause the drive to fail.

Do the following to select the test device.

1. Boot from the diagnostics diskette and start the diagnostics program.
2. See if FDD Test is passed as the program runs to FDD Test.
3. Follow the instructions in the message window.

If an error occurs with the internal diskette drive, reconnect the diskette connector on the system board.

If the error still remains:

1. Reconnect the external diskette drive/DVD-ROM module.
2. Replace the external diskette drive/CD-ROM module.
3. Replace the main board.

External CD-ROM Drive Check

Do the following to isolate the problem to a controller, drive, or CD-ROM. Make sure that the CD-ROM does not have any label attached to it. The label can cause damage to the drive or can cause the drive to fail.

Do the following to select the test device:

1. Boot from the diagnostics diskette and start the diagnostics program.
2. See if CD-ROM Test is passed when the program runs to CD-ROM Test.
3. Follow the instructions in the message window.

If an error occurs, reconnect the connector on the System board. If the error still remains:

1. Reconnect the external diskette drive/CD-ROM module.
2. Replace the external diskette drive/CD-ROM module.
3. Replace the main board.

Keyboard or Auxiliary Input Device Check

Remove the external keyboard if the internal keyboard is to be tested.

If the internal keyboard does not work or an unexpected character appears, make sure that the flexible cable extending from the keyboard is correctly seated in the connector on the system board.

If the keyboard cable connection is correct, run the Keyboard Test.

If the tests detect a keyboard problem, do the following one at a time to correct the problem. Do not replace a non-defective FRU:

1. Reconnect the keyboard cables.
2. Replace the keyboard.
3. Replace the main board.

The following auxiliary input devices are supported by this computer:

- Numeric keypad
- External keyboard

If any of these devices do not work, reconnect the cable connector and repeat the failing operation.

Memory check

Memory errors might stop system operations, show error messages on the screen, or hang the system.

1. Boot from the diagnostics diskette and start the doagmpstotics program (please refer to main board).
2. Go to the diagnostic memory in the test items.
3. Press F2 in the test items.
4. Follow the instructions in the message window.

NOTE: Make sure that the DIMM is fully installed into the connector. A loose connection can cause an error.

Power System Check

To verify the symptom of the problem, power on the computer using each of the following power sources:

1. Remove the battery pack.
2. Connect the power adapter and check that power is supplied.
3. Disconnect the power adapter and install the charged battery pack; then check that power is supplied by the battery pack.

If you suspect a power problem, see the appropriate power supply check in the following list:

- “Check the Power Adapter” on page 58
- “Check the Battery Pack” on page 59

Check the Power Adapter

Unplug the power adapter cable from the computer and measure the output voltage at the plug of the power adapter cable. See the following figure

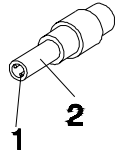

Pin 1: +19 to +20.5V
Pin 2: 0V, Ground

1. If the voltage is not correct, replace the power adapter.
2. If the voltage is within the range, do the following:
 - Replace the System board.
 - If the problem is not corrected, see “Undetermined Problems” on page 72.
 - If the voltage is not correct, go to the next step.

NOTE: An audible noise from the power adapter does not always indicate a defect.

3. If the power-on indicator does not light up, check the power cord of the power adapter for correct continuity and installation.
4. If the operational charge does not work, see “Check the Battery Pack” on page 59.

Check the Battery Pack

To check the battery pack, do the following:

From Software:

1. Check out the Power Management in control Panel
2. In Power Meter, confirm that if the parameters shown in the screen for Current Power Source and Total Battery Power Remaining are correct.
3. Repeat the steps 1 and 2, for both battery and adapter.
4. This helps you identify first the problem is on recharging or discharging.

From Hardware:

1. Power off the computer.
2. Remove the battery pack and measure the voltage between battery terminals 1(+) and 6(ground). See the following figure

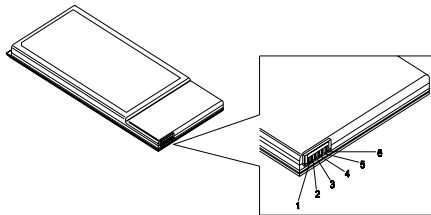

3. If the voltage is still less than 7.5 Vdc after recharging, replace the battery.

To check the battery charge operation, use a discharged battery pack or a battery pack that has less than 50% of the total power remaining when installed in the computer.

If the battery status indicator does not light up, remove the battery pack and let it return to room temperature. Re-install the battery pack.

If the charge indicator still does not light up, replace the battery pack. If the charge indicator still does not light up, replace the DC/DC charger board.

Touchpad Check

If the touchpad doesn't work, do the following actions one at a time to correct the problem. Do not replace a non-defective FRU:

1. Reconnect the touchpad cables.
2. Replace the touchpad.
3. Replace the system board.

After you use the touchpad, the pointer drifts on the screen for a short time. This self-acting pointer movement can occur when a slight, steady pressure is applied to the touchpad pointer. This symptom is not a hardware problem. No service actions are necessary if the pointer movement stops in a short period of time.

Power-On Self-Test (POST) Error Message

The POST error message index lists the error message and their possible causes. The most likely cause is listed first.

NOTE: Perform the FRU replacement or actions in the sequence shown in FRU/Action column, if the FRU replacement does not solve the problem, put the original part back in the computer. Do not replace a non-defective FRU.

This index can also help you determine the next possible FRU to be replaced when servicing a computer.

If the symptom is not listed, see “Undetermined Problems” on page 72.

The following lists the error messages that the BIOS displays on the screen and the error symptoms classified by function.

NOTE: Most of the error messages occur during POST. Some of them display information about a hardware device, e.g., the amount of memory installed. Others may indicate a problem with a device, such as the way it has been configured.

NOTE: If the system fails after you make changes in the BIOS Setup Utility menus, reset the computer, enter Setup and install Setup defaults or correct the error.

Index of Error Messages

Error Code List

Error Codes	Error Messages
006	Equipment Configuration Error Causes: 1. CPU BIOS Update Code Mismatch 2. IDE Primary Channel Master Drive Error (The causes will be shown before "Equipment Configuration Error")
010	Memory Error at xxxx:xxxx:xxxxh (R:xxxxh, W:xxxxh)
070	Real Time Clock Error
071	CMOS Battery Bad
072	CMOS Checksum Error
110	System disabled. Incorrect password is specified.
<No error code>	Battery critical LOW In this situation BIOS will issue 4 short beeps then shut down system, no message will show.
<No error code>	Thermal critical High In this situation BIOS will shut down system, not show message.

Error Message List

Error Messages	FRU/Action in Sequence
Failure Fixed Disk	Reconnect hard disk drive connector. "Load Default Settings" in BIOS Setup Utility. Hard disk drive System board
Stuck Key	see "Keyboard or Auxiliary Input Device Check" on page 56.
Keyboard error	see "Keyboard or Auxiliary Input Device Check" on page 56.
Keyboard Controller Failed	see "Keyboard or Auxiliary Input Device Check" on page 56.
Keyboard locked - Unlock key switch	Unlock external keyboard
Monitor type does not match CMOS - Run Setup	Run "Load Default Settings" in BIOS Setup Utility.
Shadow RAM Failed at offset: nnnn	BIOS ROM System board
System RAM Failed at offset: nnnn	DIMM System board
Extended RAM Failed at offset: nnnn	DIMM System board
System battery is dead - Replace and run Setup	Replace RTC battery and Run BIOS Setup Utility to reconfigure system time, then reboot system.
System CMOS checksum bad - Default configuration used	RTC battery Run BIOS Setup Utility to reconfigure system time, then reboot system.
System timer error	RTC battery Run BIOS Setup Utility to reconfigure system time, then reboot system. System board

Error Message List

Error Messages	FRU/Action in Sequence
Real time clock error	RTC battery Run BIOS Setup Utility to reconfigure system time, then reboot system. System board
Previous boot incomplete - Default configuration used	Run "Load Default Settings" in BIOS Setup Utility. RTC battery System board
Memory size found by POST differed from CMOS	Run "Load Default Settings" in BIOS Setup Utility. DIMM System board
Diskette drive A error	Check the drive is defined with the proper diskette type in BIOS Setup Utility See "External Diskette Drive Check" on page 56.
Incorrect Drive A type - run SETUP	Check the drive is defined with the proper diskette type in BIOS Setup Utility
System cache error - Cache disabled	System board
CPU ID:	System board
DMA Test Failed	DIMM System board
Software NMI Failed	DIMM System board
Fail-Safe Timer NMI Failed	DIMM System board
Device Address Conflict	Run "Load Default Settings" in BIOS Setup Utility. RTC battery System board
Allocation Error for device	Run "Load Default Settings" in BIOS Setup Utility. RTC battery System board
Failing Bits: nnnn	DIMM BIOS ROM System board
Fixed Disk n	None
Invalid System Configuration Data	BIOS ROM System board
I/O device IRQ conflict	Run "Load Default Settings" in BIOS Setup Utility. RTC battery System board
Operating system not found	Enter Setup and see if fixed disk and drive A: are properly identified. Diskette drive Hard disk drive System board

Error Message List

No beep Error Messages	FRU/Action in Sequence
No beep, power-on indicator turns off and LCD is blank.	Power source (battery pack and power adapter). See "Power System Check" on page 57.. Ensure every connector is connected tightly and correctly. Reconnect the DIMM. LED board. System board.
No beep, power-on indicator turns on and LCD is blank.	Power source (battery pack and power adapter). See "Power System Check" on page 57.. Reconnect the LCD connector Hard disk drive LCD inverter ID LCD cable LCD Inverter LCD System board
No beep, power-on indicator turns on and LCD is blank. But you can see POST on an external CRT.	Reconnect the LCD connectors. LCD inverter ID LCD cable LCD inverter LCD System board
No beep, power-on indicator turns on and a blinking cursor shown on LCD during POST.	Ensure every connector is connected tightly and correctly. System board
No beep during POST but system runs correctly.	Speaker System board

Phoenix BIOS Beep Codes

Code	Beeps	POST Routine Description
02h		Verify Real Mode
03h		Disable Non-Maskable Interrupt (NMI)
04h		Get CPU type
06h		Initialize system hardware
08h		Initialize chipset with initial POST values
09h		Set IN POST flag
0Ah		Initialize CPU registers
0Bh		Enable CPU cache
0Ch		Initialize caches to initial POST values
0Eh		Initialize I/O component
0Fh		Initialize the local bus IDE
10h		Initialize Power Management
11h		Load alternate registers with initial POST values
12h		Restore CPU control word during warm boot
13h		Initialize PCI Bus Mastering devices
14h		Initialize keyboard controller
16h	1-2-2-3	BIOS ROM checksum
17h		Initialize cache before memory autosize
18h		8254 timer initialization
1Ah		8237 DMA controller initialization
1Ch		Reset Programmable Interrupt Controller
20h	1-3-1-1	Test DRAM refresh
22h	1-3-1-3	Test 8742 Keyboard Controller
24h		Set ES segment register to 4 GB
26h		Enable A20 line
28h		Autosize DRAM
29h		Initialize POST Memory Manager
2Ah		Clear 215 KB base RAM
2Ch	1-3-4-1	RAM failure on address line xxxx
2Eh	1-3-4-3	RAM failure on data bits xxxx of low byte of memory bus
2Fh		Enable cache before system BIOS shadow
30h	1-4-1-1	RAM failure on data bits xxxx of high byte of memory bus
32h		Test CPU bus-clock frequency
33h		Initialize Phoenix Dispatch Manager
36h		Warm start shut down
38h		Shadow system BIOS ROM
3Ah		Autosize cache
3Ch		Advanced configuration of chipset registers
3Dh		Load alternate registers with CMOS values
42h		Initialize interrupt vectors
45h		POST device initialization

Code	Beeps	POST Routine Description
46h	2-1-2-3	Check ROM copyright notice
48h		Check video configuration against CMOS
49h		Initialize PCI bus and devices
4Ah		Initialize all video adapters in system
4Bh		QuietBoot start (optional)
4Ch		Shadow video BIOS ROM
4Eh		Display BIOS copyright notice
50h		Display CPU type and speed
51h		Initialize EISA board
52h		Test keyboard
54h		Set key click if enabled
58h	2-2-3-1	Test for unexpected interrupts
59h		Initialize POST display service
5Ah		Display prompt "Press F2 to enter SETUP"
5Bh		Disable CPU cache
5Ch		Test RAM between 512 and 640 KB
60h		Test extended memory
62h		Test extended memory address lines
64h		Jump to User Patch1
66h		Configure advanced cache registers
67h		Initialize Multi Processor APIC
68h		Enable external and CPU caches
69h		Setup System Management Mode (SMM) area
6Ah		Display external L2 cache size
6Bh		Load custom defaults (optional)
6Ch		Display shadow-area message
6Eh		Display possible high address for UMB recovery
70h		Display error messages
72h		Check for configuration errors
76h		Check for keyboard errors
7Ch		Set up hardware interrupt vectors
7Eh		Initialize coprocessor if present
80h		Disable onboard Super I/O ports and IRQs
81h		Late POST device initialization
82h		Detect and install external RS232 ports
83h		Configure non-MCD IDE controllers
84h		Detect and install external parallel ports
85h		Initialize PC-compatible PnP ISA devices
86h		Re-initialize onboard I/O ports
87h		Configure Motherboard Configurable Devices (optional)
88h		Initialize BIOS Area
89h		Enable Non-Maskable Interrupts (NMI)
8Ah		Initialize Extended BIOS Data Area
8Bh		Test and initialize PS/2 mouse

Code	Beeps	POST Routine Description
8Ch		Initialize floppy controller
8Fh		Determine number of ATA drives (optional)
90h		Initialize hard-disk controllers
91h		Initialize local-bus hard-disk controllers
92h		Jump to UserPatch2
93h		Build MPTABLE for multi-processor boards
95h		Install CD ROM for boot
96h		Clear huge ES segment register
97h		Fixup Multi Processor table
98h	1-2	Search for option ROMs. One long, two short beeps on checksum failure.
99h		Check for SMART drive (optional)
9Ah		Shadow option ROMs
9Ch		Set up Power Management
9Dh		Initialize security engine (optional)
9Eh		Enable hardware interrupts
9Fh		Determine number of ATA and SCSI drives
A0h		Set time of day
A2h		Check key lock
A4h		Initialize Typematic rate
A8h		Erase F2 prompt
AAh		Scan for F2 key stroke
ACh		Enter SETUP
AEh		Clear Boot flag
B0h		Check for errors
B2h		POST done- prepare to boot operating system
B4h	1	One short beep before boot
B5h		Terminate QuietBoot (optional)
B6h		Check password (optional)
B9h		Prepare Boot
BAh		Initialize DMI parameters
BBh		Initialize PnP Option ROMs
BCh		Clear parity checkers
BDh		Display MultiBoot menu
BEh		Clear screen (optional)
BFh		Check virus and backup reminders
C0h		Try to boot with INT 19
C1h		Initialize POST Error Manager (PEM)
C2h		Initialize error logging
C3h		Initialize error display function
C4h		Initialize system error handler
C5h		PnPnd dual CMOS (optional)
C6h		Initialize notebook docking (optional)
C7h		Initialize notebook docking late
C8h		Force check (optional)
C9h		Extended checksum (optional)

Code	Beeps	POST Routine Description
D2h		Unknown interrupt

Code	Beeps	POST Routine Description
E0h		Initialize the chipset
E1h		Initialize the bridge
E2h		Initialize the CPU
E3h		Initialize the system timer
E4h		Initialize system I/O
E5h		Check force recovery boot
E6h		Checksum BIOS ROM
E7h		Go to BIOS
E8h		Set Huge Segment
E9h		Initialize Multi Processor
EAh		Initialize OEM special code
EBh		Initialize PIC and DMA
ECh		Initialize Memory type
EDh		Initialize Memory size
EEh		Shadow Boot Block
EFh		System memory test
F0h		Initialize interrupt vectors
F1h		Initialize Run Time Clock
F2h		Initialize video
F3h		Initialize System Management Mode
F4h	1	Output one beep before boot
F5h		Boot to Mini DOS
F6h		Clear Huge Segment
F7h		Boot to Full DOS

Index of Symptom-to-FRU Error Message

LCD-Related Symptoms

Symptom / Error	Action in Sequence
LCD backlight doesn't work LCD is too dark LCD brightness cannot be adjusted LCD contrast cannot be adjusted	Enter BIOS Utility to execute "Load Setup Default Settings", then reboot system. Reconnect the LCD connectors. Keyboard (if contrast and brightness function key doesn't work). LCD inverter ID LCD cable LCD inverter LCD System board
Unreadable LCD screen Missing pels in characters Abnormal screen Wrong color displayed	Reconnect the LCD connector LCD inverter ID LCD cable LCD inverter LCD System board
LCD has extra horizontal or vertical lines displayed.	LCD inverter ID LCD inverter LCD cable LCD System board

Indicator-Related Symptoms

Symptom / Error	Action in Sequence
Indicator incorrectly remains off or on, but system runs correctly	Reconnect the inverter board Inverter board System board

Power-Related Symptoms

Symptom / Error	Action in Sequence
Power shuts down during operation	Power source (battery pack and power adapter). See "Power System Check" on page 57. Battery pack Power adapter Hard drive & battery connection board System board
The system doesn't power-on.	Power source (battery pack and power adapter). See "Power System Check" on page 57. Battery pack Power adapter Hard drive & battery connection board System board
The system doesn't power-off.	Power source (battery pack and power adapter). See "Power System Check" on page 57. Hold and press the power switch for more than 4 seconds. System board

Power-Related Symptoms

Symptom / Error	Action in Sequence
Battery can't be charged	See "Check the Battery Pack" on page 59. Battery pack System board

PCMCIA-Related Symptoms

Symptom / Error	Action in Sequence
System cannot detect the PC Card (PCMCIA)	PCMCIA slot assembly System board
PCMCIA slot pin is damaged.	PCMCIA slot assembly

Memory-Related Symptoms

Symptom / Error	Action in Sequence
Memory count (size) appears different from actual size.	Enter BIOS Setup Utility to execute "Load Default Settings, then reboot system. DIMM System board

Speaker-Related Symptoms

Symptom / Error	Action in Sequence
In Windows, multimedia programs, no sound comes from the computer.	Audio driver Speaker System board
Internal speakers make noise or emit no sound.	Speaker System board

Power Management-Related Symptoms

Symptom / Error	Action in Sequence
The system will not enter hibernation	See "Save to Disk (S4)" on page 26. Keyboard (if control is from the keyboard) Hard disk drive System board
The system doesn't enter hibernation mode and four short beeps every minute.	Press Fn+  and see if the computer enters hibernation mode. Touchpad Keyboard Hard disk connection board Hard disk drive System board
The system doesn't enter standby mode after closing the LCD	See "Save to Disk (S4)" on page 26. LCD cover switch System board
The system doesn't resume from hibernation mode.	See "Save to Disk (S4)" on page 26. Hard disk connection board Hard disk drive System board
The system doesn't resume from standby mode after opening the LCD.	See "Save to Disk (S4)" on page 26. LCD cover switch System board

Power Management-Related Symptoms

Symptom / Error	Action in Sequence
Battery fuel gauge in Windows doesn't go higher than 90%.	Remove battery pack and let it cool for 2 hours. Refresh battery (continue use battery until power off, then charge battery). Battery pack System board
System hangs intermittently.	Reconnect hard disk/CD-ROM drives. Hard disk connection board System board

Peripheral-Related Symptoms

Symptom / Error	Action in Sequence
System configuration does not match the installed devices.	Enter BIOS Setup Utility to execute "Load Default Settings", then reboot system. Reconnect hard disk/CD-ROM/diskette drives.
External display does not work correctly.	Press Fn+F5, LCD/CRT/Both display switching System board
USB does not work correctly	System board
Print problems.	Ensure the "Parallel Port" in the "Onboard Devices Configuration" of BIOS Setup Utility is set to Enabled. Onboard Devices Configuration Run printer self-test. Printer driver Printer cable Printer System Board
Serial or parallel port device problems.	Ensure the "Serial Port" in the Devices Configuration" of BIOS Setup Utility is set to Enabled. Device driver Device cable Device System board

Keyboard/Touchpad-Related Symptoms

Symptom / Error	Action in Sequence
Keyboard (one or more keys) does not work.	Reconnect the keyboard cable. Keyboard System board
Touchpad does not work.	Reconnect touchpad cable. Touchpad board System board

Modem-Related Symptoms

Symptom / Error	Action in Sequence
Internal modem does not work correctly.	Modem phone port modem combo board System board

NOTE: If you cannot find a symptom or an error in this list and the problem remains, see "Undetermined Problems" on page 72.

Intermittent Problems

Intermittent system hang problems can be caused by a variety of reasons that have nothing to do with a hardware defect, such as: cosmic radiation, electrostatic discharge, or software errors. FRU replacement should be considered only when a recurring problem exists.

When analyzing an intermittent problem, do the following:

1. Run the advanced diagnostic test for the system board in loop mode at least 10 times.
2. If no error is detected, do not replace any FRU.
3. If any error is detected, replace the FRU. Rerun the test to verify that there are no more errors.

Undetermined Problems

The diagnostic problems does not identify which adapter or device failed, which installed devices are incorrect, whether a short circuit is suspected, or whether the system is inoperative.

Follow these procedures to isolate the failing FRU (do not isolate non-defective FRU).

NOTE: Verify that all attached devices are supported by the computer.

NOTE: Verify that the power supply being used at the time of the failure is operating correctly. (See "Power System Check" on page 57.):

1. Power-off the computer.
2. Visually check them for damage. If any problems are found, replace the FRU.
3. Remove or disconnect all of the following devices:
 - Non-Acer devices
 - Printer, mouse, and other external devices
 - Battery pack
 - Hard disk drive
 - DIMM
 - CD-ROM/Diskette drive Module
 - PC Cards
4. Power-on the computer.
5. Determine if the problem has changed.
6. If the problem does not recur, reconnect the removed devices one at a time until you find the failing FRU.
7. If the problem remains, replace the following FRU one at a time. Do not replace a non-defective FRU:
 - System board
 - LCD assembly

FRU (Field Replaceable Unit) List

This chapter gives you the FRU (Field Replaceable Unit) listing in global configurations of Aspire 3610. Refer to this chapter whenever ordering for parts to repair or for RMA (Return Merchandise Authorization).



Please note that WHEN ORDERING FRU PARTS, you should check the most up-to-date information available on your regional web or channel. For whatever reasons a part number change is made, it will not be noted on the printed Service Guide. For ACER AUTHORIZED SERVICE PROVIDERS, your Acer office may have a DIFFERENT part number code from those given in the FRU list of this printed Service Guide. You MUST use the local FRU list provided by your regional Acer office to order FRU parts for repair and service of customer machines.

NOTE: To scrap or to return the defective parts, you should follow the local government ordinance or regulations on how to dispose it properly, or follow the rules set by your regional Acer office on how to return it.

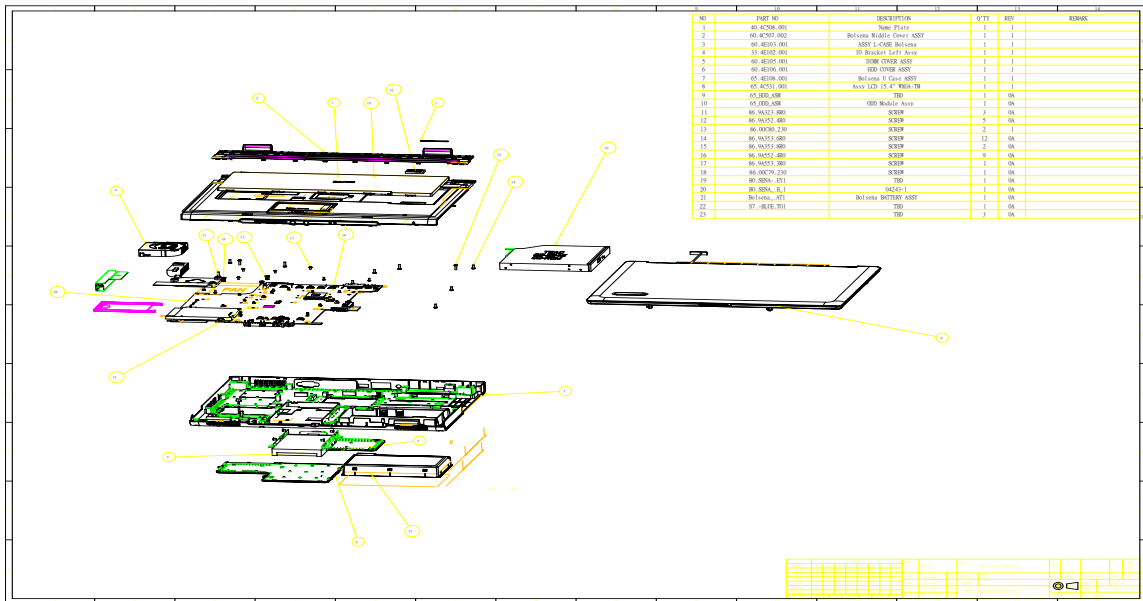
Aspire 3610 Exploded Diagram



Aspire 3610 FRU List

ADAPTER			
	N/A	ADAPTER 65W HIPRO HP-OK066B13WI	AP.0650A.005
	N/A	ADAPTER 65W LITEON PA-1650-02WE	AP.06503.008
	N/A	ADAPTER 65W DELTA SADP-65KB DBE	AP.06501.007
BATTERY			
	21	BATTERY PACK LI+ 4CELL 2.0MAH SANYO	BT.00403.005
		BATTERY PACK LI+ 4CELL 3.0MAH SMP	BT.00407.002
		BATTERY PACK LI+ 4CELL 2.0MAH SONY	BT.00404.005
		BATTERY PACK LI+ 8CELL 2.2MAH SONY	BT.00804.007
		BATTERY PACK LI+ 8CELL 2.2MAH PANASONIC	BT.00805.002
	N/A	RTC BATTERY	23.22019.001
BOARDS			

Aspire 3610 FRU List

	N/A	WIRELESS LAN BOARD 802.11BG FOXCONN ATHEROS EU	54.0309C.011
		WIRELESS LAN BOARD 802.11BG FOXCONNBCM4318 MURA	54.0309D.002
	22	BLUETOOTH BOARD WNC BC92035	56.25004.041
		BLUETOOTH BOARD FOXCONN BCM2045	56.25020.001
	N/A	TOUCHPAD BOARD SYNPATICT M61PUF1G372	56.17004.071
	N/A	MODEM BOARD FOXCONN T60M845.01	54.09011.641
CABLE			
	N/A	TOUCHPAD CABLE	50.4E102.001
	N/A	POWER CORD 10A 125V US	27.01518.521
	N/A	COVER SWITCH CABLE	50.4C506.001
	N/A	MODEM CABLE	50.4C504.001
CASE/COVER/BRACKET ASSEMBLY			
	2	MIDDLE COVER	60.4C507.004
	6	HDD COVER	60.4E106.001
	3	LOWER CASE W/DIMM COVER & SPEAKER	60.4E103.001





Aspire 3610 FRU List

	7	UPPER CASE W/COVER SWITCH CABLE	60.4E101.001
	N/A	PCMCIA DUMMY CARD	42.4C518.001
	N/A	TOUCHPAD BRACKET	60.4C510.002
	5	DIMM COVER	60.4E105.001
	N/A	HINGE PACK 15.4" LEFT/RIGHT	6K.4C5CS.001
COMBO Drive			
	10	COMBO MODULE 24X	65.4E104.001
	N/A	OPTICAL BRACKET	33.4C511.002
	N/A	ODD BEZEL	60.4E108.001



Aspire 3610 FRU List

	N/A	CDRW/DVD COMBO MODULE 24X PHILIPS SCB5265 W/O BEZEL	KO.02403.007
		CDRW/DVD COMBO MODULE 24X TOSHIBA TS-L462C W/O BEZEL	KO.02404.005
		CDRW/DVD COMBO MODULE 24X LITEON SOSW-2483K W/O BEZEL	KO.02409.006
		CDRW/DVD COMBO MODULE 24X HLDS GCC-4244N W/O BEZEL	KO.0240A.004
COMMUNICATION MODULE			
	N/A	WIRELESS ANTENNA	25.90225.001
	N/A	BLUETOOTH ANTENNA	50.4C505.001
CPU/PROCESSOR			
	N/A	CPU CEL-M370 1.5G MHZ INTEL	KC.NC001.370
	N/A	CPU DOTHAN725A 1.6GMHZ INTEL	KC.NA001.725
	N/A	CPU CEL-M360 1.4GMHZ INTEL	KC.N0001.360
	N/A	CPU CEL-M360 1.4GMHZ INTEL	KC.NC001.360
	N/A	CPU CEL-M380 1.6GMHZ INTEL	KC.NC001.380
	N/A	CPU DOTHAN730 1.6GMHZ INTEL	KC.N0001.730
	N/A	CPU DOTHAN740 1.73GMHZ INTEL	KC.N0001.740
	N/A	CPU DOTHAN750 1.87GMHZ INTEL	KC.N0001.750
	N/A	CPU DOTHAN760 2GMHZ INTEL	KC.N0001.760
	N/A	CPU DOTHAN770 2.13GMHZ INTEL	KC.N0001.770
DVD-RW DRIVE			
	10	DVD-RW MODUL 8X DUAL	65.4E105.001
	N/A	OPTICAL BRACKET	33.4C511.002
	N/A	ODD BEZEL	60.4E108.001
	N/A	DVD-RW DRIVE 8X DUAL LITEON SOSW-833S W/O BEZEL	KU.00804.012
	N/A	DVD-RW DRIVE 8X DUAL PIONEER DVR-K15RA W/O BEZEL	KU.00805.012
	N/A	DVD-RW DRIVE 8X DUAL TOSHIBA TS-L532U W/O BEZEL	KU.00801.005
	N/A	DVD-RW DRIVE 8X DUAL HLDS GWA-4082N W/O BEZEL	KU.0080D.016
	N/A	DVD-RW DRIVE DUAL PHILIPS SDVD8441 W/O BEZEL	KU.00809.002



Aspire 3610 FRU List

FAN			
	4	FAN	23.10122.001
HARD DISK DRIVE			
	9	HDD MODULE 40G	65.4E102.001
	N/A	HDD BRACKET	60.4E107.001
	N/A	HDD 40G 4200PRM SEAGATE ST94019A	KH.04001.010
		HDD 40G TOSHIBA MK4025GAS	KH.04004.005
		HDD 40G HITACHI HTS424040M9AT00	KH.04007.012
		HDD 40G WD WD400UE-00HCT0	KH.04008.020
		HDD 40G SAMSUNG MP0402H	KH.0400B.002
		HDD MODULE 60G	65.4E101.001
		HDD BRACKET	60.4E107.001
		HDD 60G SEAGATE ST960821A	KH.06001.002
		HDD 60G TOSHIBA MK6025GAS	KH.06004.004
		HDD 60G HITACHI C25N060ATMR04	KH.06007.006
		HDD MODULE 80G	65.4E103.001
		HDD BRACKET	60.4E107.001
		HDD 80G TOSHIBA MK8025GAS	KH.08004.003
HDD 80G HITACHI IC25N080ATMR04	KH.08007.007		
HEATSINK			
	N/A	CPU HEATSINK W/O FAN	60.4E114.001
LCD			

Aspire 3610 FRU List

	8	LCD MODULE 15" XGA	65.4E106.001
	N/A	INVERTER BOARD 15.4" DARFON	19.21066.002
	N/A	LCD BRACKET 15" RIGHT Note: The image displays LCD bracket right and left.	33.4C503.001
	N/A	LCD BRACKET 15" LEFT Note: The image displays LCD bracket right and left.	33.4C504.001
	N/A	LCD CABLE 15" XGA FVC	50.4C510.001
	N/A	LCD BEZEL 15.4" W/LOGO	60.4C503.004
	N/A	LCD PANEL 15" W/HINGE&LOGO	60.4C519.004

Aspire 3610 FRU List

	N/A	LCD 15" XGA LG LP150X08-TLA2	LK.15008.019
		LCD 15" XGA QDI QD150XL06-L3	LK.15009.008
	8	LCD MODULE 15.4" WXGA	65.4E107.011
	N/A	INVERTER BOARD 15.4" DARFON	19.21066.002
	N/A	LCD BRACKET 15.4" RIGHT	33.4C501.002
	N/A	LCD BRACKET 15.4" LEFT	33.4C502.002
	N/A	LCD CABLE 15.4" TFT WXGA	50.4C509.001
	N/A	LCD BEZEL 15.4" W/LOGO	60.4C502.004
	N/A	LCD PANEL 15.4" W/HINGE&LOGO	60.4C518.004
	N/A	LCD 15.4" WXGA LG B154EW01 V.8	LK.15405.005
	N/A	LCD 15.4" WXGA SAMSUNG LTN154X3-L01-G	LK.15406.006
	N/A	LCD 15.4" WXGA LG LP154W01- TLA2	LK.15408.014
	N/A	LCD 15.4" WXGA CHIMEI N154I1- L07	LK.1540D.004
MAINBOARD			
	20	MAINBOARD MORAR W/O CPU W/ MODEM & MODEM CABLE & PCMCIA SLOT & RTC BATTERY	55.4E101.D02
MEMORY			
	N/A	SDIMM 256M NANYA NT256T64UH4A0FN-37B	KN.25603.020
	N/A	SDIMM 256M HYNIX HYMP532S64P6-C4	KN.2560G.006
	N/A	SDIMM 256M INFINEON HYS64T32000HDL-3.7-A	KN.25602.023
	N/A	SDIMM 256M MICRON MT4HTF3264HY-53EB3	KN.25604.027
	N/A	SDIMM 256M SAMSUNG M470T3354BZ0-CD5	KN.2560B.011
	N/A	SDIMM 512 INFINEON MHYS64T64020HDL-3.7-A	KN.51202.021

Aspire 3610 FRU List

	N/A	SDIMM 512M NANYA NT512T64UH8A0FN-37B	KN.51203.018
	N/A	SDIMM 512M MICRON MT8HTF6464HDY-53EB3	KN.51204.019
	N/A	SDIMM 512M SAMSUNG M470T6554BZ0-CD5	KN.5120B.008
	N/A	SDIMM 512M HYNIX HYMP564S64P6-C4	KN.5120G.005
	N/A	SDIMM 256M MICRON MT8HTF3264HDY-40EB3	KN.25604.022
	N/A	SDIMM 512M MICRON MT8HTF6464HDY-40EB3	KN.51204.020
	N/A	SDIMM 256M MICRON MT4HTF3264HY-40EB3	KN.25604.028
MICROPHONE			
	N/A	MICROPHONE	23.42068.001
KEYBOARD			
	19	KEYBOARD 88KEY DARFON NSK- H3M1D UI	99.N5982.M1D
		KEYBOARD 89KEY DARFON NSK- H3M0U UK	99.N5982.M0U
		KEYBOARD 88KEY SUNREX K032130A1 UI	90.4C507.S1D
		KEYBOARD 88KEY DARFON NSK- H30M02 CH	99.N5982.M02
		KEYBOARD 89KEY DARFON NSK- H3M0S SP	99.N5982.M0S
		AS1680/AS1410 KEYBOARD DARFON THAI	TBD
		AS1680/AS1410 KEYBOARD DARFON BRAZILIAN PROTUGESE	TBD
		AS1680/AS1410 KEYBOARD DARFON KOREA	TBD
		KEYBOARD 89KEY DARFON NSK- H30M0G GERMAN	99.N5982.M0G
		KEYBOARD 89KEY DARFON NSK- H30M0E I IT	99.N5982.M0E
		KEYBOARD 89KEY DARFON NSK- H3M0F FRENCH	99.N5982.M0F
		KEYBOARD 89KEY DARFON NSK- H3M00 SW	99.N5982.M00
		AS1680/AS1410 KEYBOARD DARFON PORTUGUESE	TBD

Aspire 3610 FRU List

		AS1680/AS1410 KEYBOARD DARFON ARABIC	TBD
		KEYBOARD 89KEY DARFON NSK- H3M1A BE	99.N5982.M1A
		KEYBOARD 89KEY DARFON NSK- H3M0W SD	99.N5982.M0W
		AS1680/AS1410 KEYBOARD DARFON CZECH	TBD
		KEYBOARD 89KEY DARFON NSK- H3M0Q HG	99.N5982.M0Q
		KEYBOARD 89KEY DARFON NSK- H3M0N NW	99.N5982.M0N
		KEYBOARD 89KEY DARFON NSK- H3M0D DM	99.N5982.M0D
		AS1680/AS1410 KEYBOARD DARFON TURKISH	TBD
		AS1680/AS1410 KEYBOARD DARFON CANADIAN FRENCH	TBD
		AS1680/AS1410 KEYBOARD DARFON JAPANESE	TBD
		KEYBOARD 88KEY DARFON NSK- H3M0L GK	99.N5982.M0L
		KEYBOARD 88KEY DARFON NSK- H3M0H HB	99.N5982.M0H
		KEYBOARD 88KEY DARFON NSK- H3M0R RU	99.N5982.M0R
		AS1680/AS1410 KEYBOARD DARFON SLOVENIA	TBD
		AS1680/AS1410 KEYBOARD DARFON CROATIA	TBD
HEATSINK			
	N/A	NORTH BRIDGE PLATE	60.4E113.001
MISCELLANEOUS			
	N/A	LCD SCREW RUBBER	47.4C505.001
	N/A	LCD SCREW RUBBER	47.4C506.001
	N/A	LOGO PLATE PANEL	31.45I06.001
	N/a	LOGO PLATE BEAEL	31.4C509.001
PCMCIA SLOT/PC CARD SLOT			
	N/A	PCMCIA SLOT	21.H0056.001
SPEAKER			
	N/A	SPEAKER LEFT/RIGHT	23.40153.001
SCREW			
	N/A	SCREW	34.00015.081
	N/A	SCREW	86.00059.220
	N/A	SCREW	86.00D01.230

Aspire 3610 FRU List

	N/A	SCREW	86.00D02.230
	N/A	SCREW	86.9A323.6R0
	11	SCREW	86.9A323.8R0
	N/A	SCREW	86.9A352.3R0
	12	SCREW	86.9A352.4R0
	N/A	SCREW	86.9A353.4R0
	14	SCREW	86.9A353.6R0
	15	SCREW	86.9A353.8R0
	N/A	SCREW	86.9A523.3R0
	N/A	SCREW	86.9A524.4R0
	N/A	SCREW	86.9A552.3R0
	16	SCREW	86.9A552.4R0
	17	SCREW	86.9A553.3R0

A

AC Adapter 28
 AFLASH Utility 43
 Audio 20

B

Battery 27
 BIOS 20

- package 20
- ROM size 20
- ROM type 20
- vendor 20
- Version 20

 BIOS Supports protocol 20
 BIOS Utility 32

- Navigating 33
- Onboard Device Configuration 38
- Startup Configuration 37
- System Security 42

 Board Layout

- Bottom View 6, 86
- Top View 5, 84

 brightness

- hotkeys 16

C

Cache

- controller 20
- size 21

 caps lock

- on indicator 12

 CardBus 26
 Chipsets 20
 contrast

- hotkeys 16

 Controllers 20
 Core logic 20
 CPU

- core voltage 20
- I/O voltage 20
- package 20
- type 20

D

DIMM

- Combinations 21

 Disassembly

Battery Pack 49
 Procedure Flowchart 48

Display 2
 display

- hotkeys 16

 Display Standby Mode 29
 DVD-ROM Interface 23, 24

E

Environmental Requirements 29
 Error Symptom-to-Spare Part Index 71
 External CD-ROM Drive Check 67

F

Features 1
 Flash Utility 43
 Floppy Disk Drive Interface 22
 FRU (Field Replaceable Unit) List 88

H

Hard disk 23
 Hard Disk Standby Mode 29
 Hardware Specifications and Configurations 20
 HDD 23
 Hibernation Mode 29
 Hibernation mode

- hotkey 16

 Hot Keys 15

I

Indicators 12
 Intermittent Problems 82

J

Jumper and Connector Locations 84

- Top View 84

K

Keyboard 20, 27
 Keyboard or Auxiliary Input Device Check 67

L

L2 cache 20

M

Mechanical Specification 30

media access

on indicator 12

Memory Check 68

Model Definition 101

Modem 22

N

Notebook Manager

hotkey 16

num lock

on indicator 12

O

Online Support Information 110

P

Panel

Bottom 11

right 10

PC Card 12, 26

PCMCIA 26

Power Management 29

Power System Check 68

Battery Pack 70

Power Adapter 69

R

Removing the Battery Pack 50

S

Second Level Cache 20

speakers

hotkey 16

Standby Mode 29

System Check Procedures 67

System Diagnostic Diskette 43

System Memory 21

System Utilities 32

System Utility Diskette 43

T

Temperature 29

Test Compatible Components 104

Touchpad 20

touchpad

hotkey 16

Touchpad Check 70

Troubleshooting 66

U

Undetermined Problems 83

USB 26

utility

BIOS 32

V

Video 25

Resolutions 26

Video controller 20

