

## SIPMOS® Small-Signal Transistor

- N channel
- Enhancement mode
- Logic Level
- $V_{GS(th)} = 0.8...2.0V$

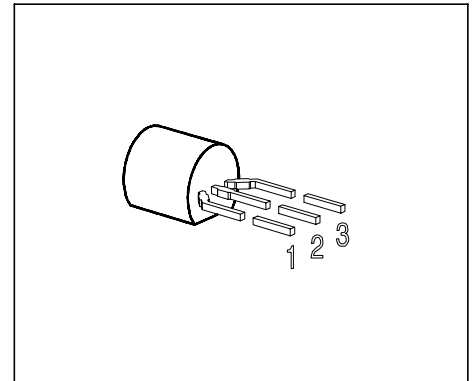

|       |       |       |
|-------|-------|-------|
| Pin 1 | Pin 2 | Pin 3 |
| G     | D     | S     |

| Type    | $V_{DS}$ | $I_D$ | $R_{DS(on)}$ | Package | Marking |
|---------|----------|-------|--------------|---------|---------|
| BSS 295 | 50 V     | 1.4 A | 0.3 $\Omega$ | TO-92   | SS 295  |

| Type    | Ordering Code | Tape and Reel Information |
|---------|---------------|---------------------------|
| BSS 295 | Q67000-S238   | E6288                     |
| BSS 295 | Q67000-S105   | E6325                     |

### Maximum Ratings

| Parameter   | Symbol      | Values   | Unit |
|---|-------------|----------|------|
| Drain source voltage  | $V_{DS}$    | 50       | V    |
| Drain-gate voltage<br>$R_{GS} = 20 \text{ k}\Omega$           | $V_{DGR}$   | 50       |      |
| Gate source voltage   | $V_{GS}$    | $\pm 14$ |      |
| Gate-source peak voltage, aperiodic                           | $V_{gs}$    | $\pm 20$ |      |
| Continuous drain current<br>$T_A = 24 \text{ }^\circ\text{C}$ | $I_D$       | 1.4      | A    |
| DC drain current, pulsed<br>$T_A = 25 \text{ }^\circ\text{C}$ | $I_{Dpuls}$ | 5.6      |      |
| Power dissipation<br>$T_A = 25 \text{ }^\circ\text{C}$        | $P_{tot}$   | 1        | W    |

## Maximum Ratings

| Parameter   | Symbol     | Values        | Unit |
|---|------------|---------------|------|
| Chip or operating temperature                         | $T_j$      | -55 ... + 150 | °C   |
| Storage temperature                                   | $T_{stg}$  | -55 ... + 150 |      |
| Thermal resistance, chip to ambient air <sup>1)</sup> | $R_{thJA}$ | ≤ 125         | K/W  |
| DIN humidity category, DIN 40 040                     |            | E             |      |
| IEC climatic category, DIN IEC 68-1                   |            | 55 / 150 / 56 |      |

## Electrical Characteristics, at $T_j = 25^\circ\text{C}$ , unless otherwise specified

| Parameter | Symbol | Values |      |      | Unit |
|-----------|--------|--------|------|------|------|
|           |        | min.   | typ. | max. |      |

## Static Characteristics

|   |               |     |      |     |    |
|---|---------------|-----|------|-----|----|
| Drain- source breakdown voltage<br>$V_{GS} = 0 \text{ V}$ , $I_D = 0.25 \text{ mA}$ , $T_j = 25 \text{ }^\circ\text{C}$ | $V_{(BR)DSS}$ | 50  | -    | -   | V  |
| Gate threshold voltage<br>$V_{GS} = V_{DS}$ , $I_D = 1 \text{ mA}$  | $V_{GS(th)}$  | 0.8 | 1.4  | 2   |    |
| Zero gate voltage drain current<br>$V_{DS} = 50 \text{ V}$ , $V_{GS} = 0 \text{ V}$ , $T_j = 25 \text{ }^\circ\text{C}$ | $I_{DSS}$     | -   | 0.1  | 1   | μA |
| $V_{DS} = 50 \text{ V}$ , $V_{GS} = 0 \text{ V}$ , $T_j = 125 \text{ }^\circ\text{C}$                                   |               | -   | 8    | 50  |    |
| $V_{DS} = 30 \text{ V}$ , $V_{GS} = 0 \text{ V}$ , $T_j = 25 \text{ }^\circ\text{C}$                                    |               | -   | -    | 100 | nA |
| Gate-source leakage current<br>$V_{GS} = 20 \text{ V}$ , $V_{DS} = 0 \text{ V}$   | $I_{GSS}$     | -   | 10   | 100 | nA |
| Drain-Source on-state resistance<br>$V_{GS} = 10 \text{ V}$ , $I_D = 1.4 \text{ A}$                                     | $R_{DS(on)}$  | -   | 0.25 | 0.3 | Ω  |
| $V_{GS} = 4.5 \text{ V}$ , $I_D = 1.4 \text{ A}$  |               | -   | 0.45 | 0.5 |    |

### Electrical Characteristics, at $T_j = 25^\circ\text{C}$ , unless otherwise specified

| Parameter | Symbol | Values |      |      | Unit |
|-----------|--------|--------|------|------|------|
|           |        | min.   | typ. | max. |      |

### Dynamic Characteristics

|  |              |     |     |     |    |
|--|--------------|-----|-----|-----|----|
| Transconductance<br>$V_{DS} \geq 2 * I_D * R_{DS(on)max}, I_D = 1.4 \text{ A}$                                   | $g_{fs}$     | 0.5 | 1.6 | -   | S  |
| Input capacitance<br>$V_{GS} = 0 \text{ V}, V_{DS} = 25 \text{ V}, f = 1 \text{ MHz}$                            | $C_{iss}$    | -   | 320 | 425 | pF |
| Output capacitance<br>$V_{GS} = 0 \text{ V}, V_{DS} = 25 \text{ V}, f = 1 \text{ MHz}$                           | $C_{oss}$    | -   | 110 | 170 |    |
| Reverse transfer capacitance<br>$V_{GS} = 0 \text{ V}, V_{DS} = 25 \text{ V}, f = 1 \text{ MHz}$                 | $C_{rss}$    | -   | 50  | 75  |    |
| Turn-on delay time<br>$V_{DD} = 30 \text{ V}, V_{GS} = 10 \text{ V}, I_D = 0.29 \text{ A}$<br>$R_G = 50 \Omega$  | $t_{d(on)}$  | -   | 8   | 12  | ns |
| Rise time<br>$V_{DD} = 30 \text{ V}, V_{GS} = 10 \text{ V}, I_D = 0.29 \text{ A}$<br>$R_G = 50 \Omega$           | $t_r$        | -   | 20  | 30  |    |
| Turn-off delay time<br>$V_{DD} = 30 \text{ V}, V_{GS} = 10 \text{ V}, I_D = 0.29 \text{ A}$<br>$R_G = 50 \Omega$ | $t_{d(off)}$ | -   | 120 | 160 |    |
| Fall time<br>$V_{DD} = 30 \text{ V}, V_{GS} = 10 \text{ V}, I_D = 0.29 \text{ A}$<br>$R_G = 50 \Omega$           | $t_f$        | -   | 85  | 115 |    |

**Electrical Characteristics, at  $T_j = 25^\circ\text{C}$ , unless otherwise specified**

| Parameter | Symbol | Values |      |      | Unit |
|-----------|--------|--------|------|------|------|
|           |        | min.   | typ. | max. |      |

**Reverse Diode**

|  |          |   |   |     |   |
|--|----------|---|---|-----|---|
| Inverse diode continuous forward current<br>$T_A = 25^\circ\text{C}$       | $I_S$    | - | - | 1.4 | A |
| Inverse diode direct current, pulsed<br>$T_A = 25^\circ\text{C}$           | $I_{SM}$ | - | - | 5.6 |   |
| Inverse diode forward voltage<br>$V_{GS} = 0\text{ V}, I_F = 2.8\text{ A}$ | $V_{SD}$ | - | 1 | 1.5 | V |

### Power dissipation

$$P_{\text{tot}} = f(T_A)$$

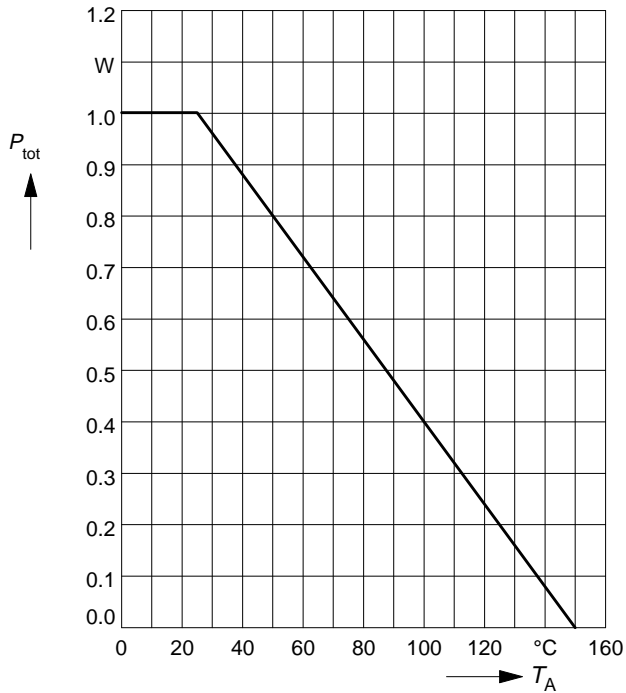

### Drain current

$$I_D = f(T_A)$$

parameter:  $V_{GS} \geq 10 \text{ V}$

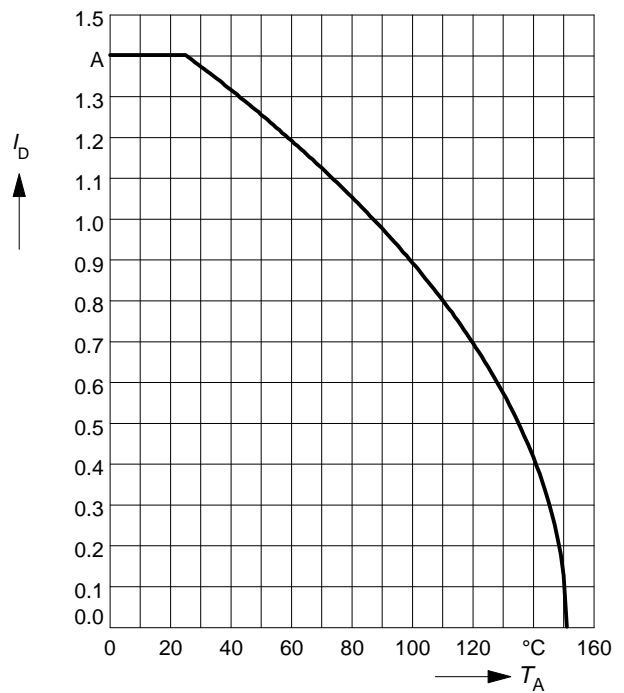

### Safe operating area $I_D = f(V_{DS})$

parameter:  $D = 0.01$ ,  $T_C = 25^\circ\text{C}$

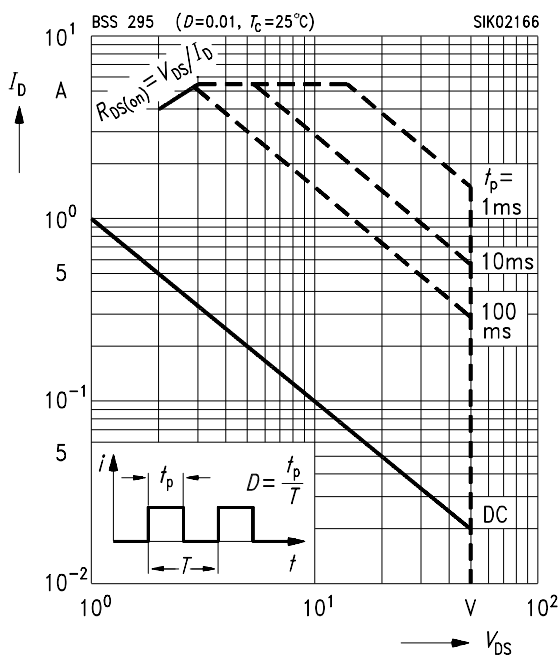

### Drain-source breakdown voltage

$$V_{(BR)DSS} = f(T_j)$$

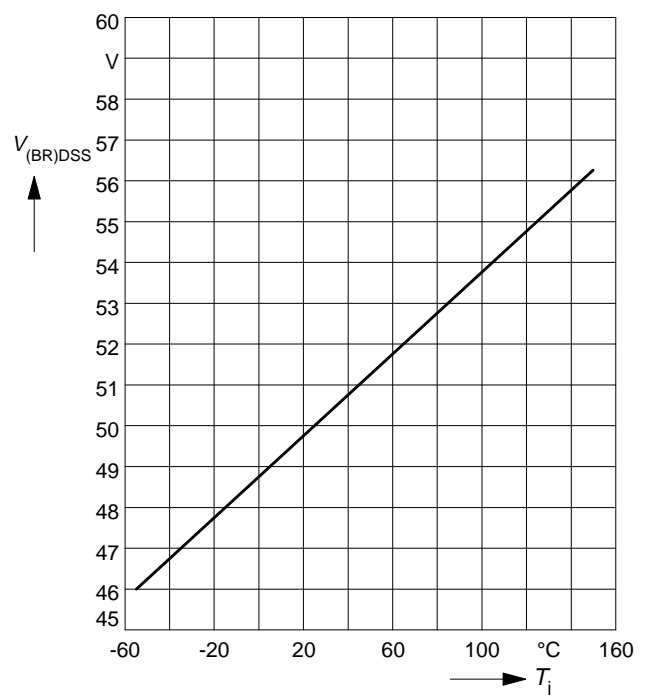

### Typ. output characteristics

$$I_D = f(V_{DS})$$

parameter:  $t_p = 80 \mu s$ ,  $T_j = 25^\circ C$

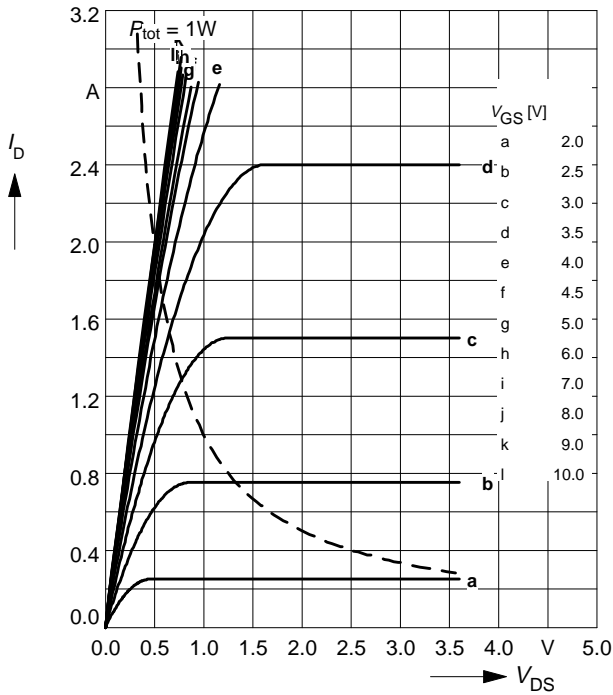

### Typ. drain-source on-resistance

$$R_{DS(on)} = f(I_D)$$

parameter:  $t_p = 80 \mu s$ ,  $T_j = 25^\circ C$

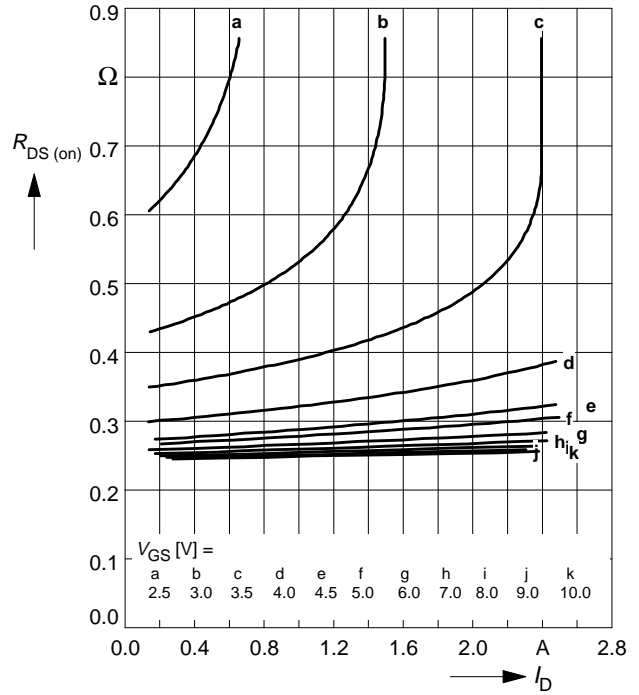

### Typ. transfer characteristics $I_D = f(V_{GS})$

parameter:  $t_p = 80 \mu s$

$V_{DS} \geq 2 \times I_D \times R_{DS(on)max}$

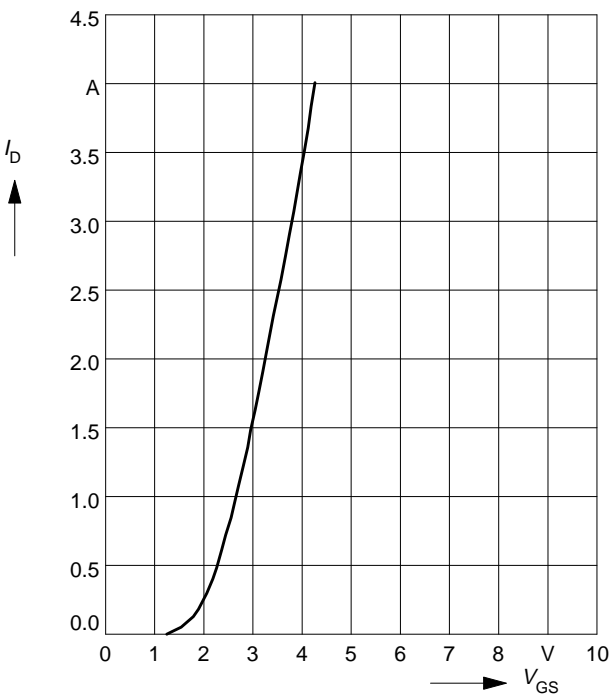

### Typ. forward transconductance $g_{fs} = f(I_D)$

parameter:  $t_p = 80 \mu s$ ,

$V_{DS} \geq 2 \times I_D \times R_{DS(on)max}$

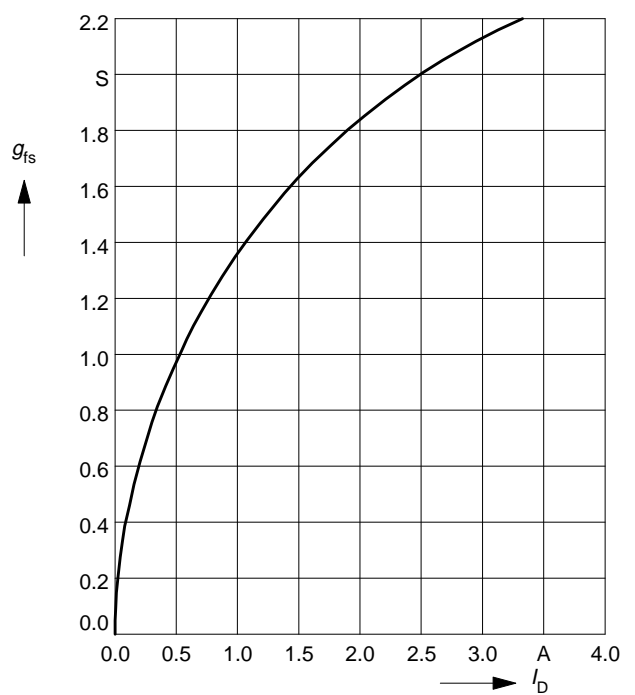

### Drain-source on-resistance

$$R_{DS(on)} = f(T_j)$$

parameter:  $I_D = 1.4 \text{ A}$ ,  $V_{GS} = 10 \text{ V}$

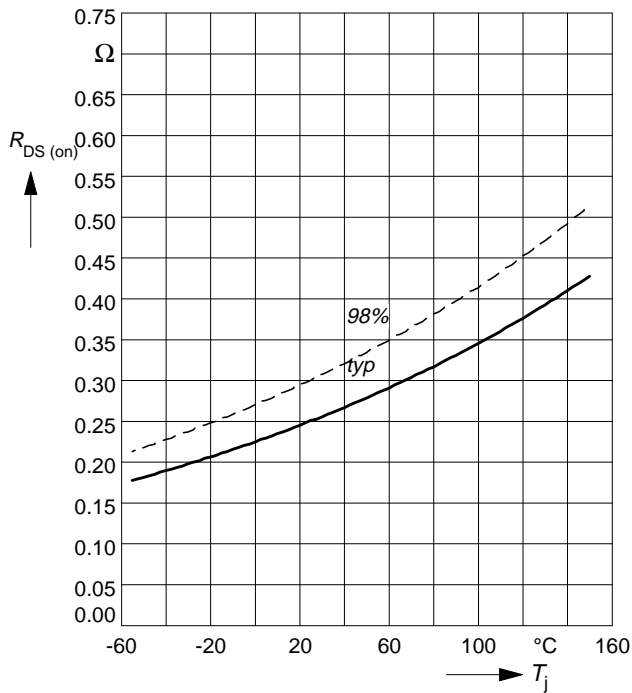

### Gate threshold voltage

$$V_{GS(th)} = f(T_j)$$

parameter:  $V_{GS} = V_{DS}$ ,  $I_D = 1 \text{ mA}$

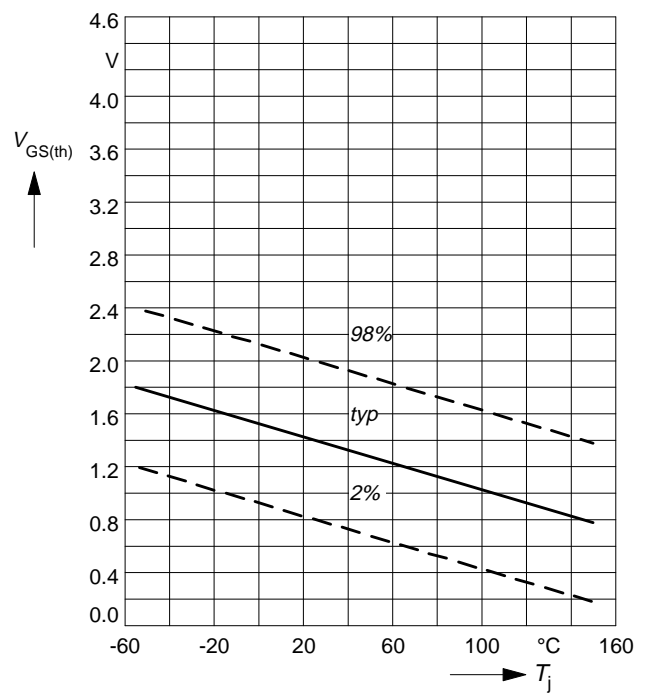

### Typ. capacitances

$$C = f(V_{DS})$$

parameter:  $V_{GS}=0\text{V}$ ,  $f = 1 \text{ MHz}$

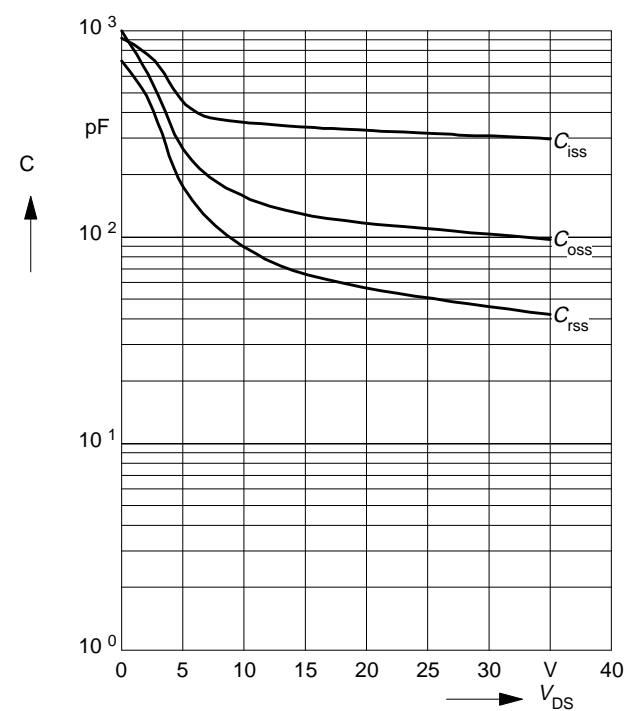

### Forward characteristics of reverse diode

$$I_F = f(V_{SD})$$

parameter:  $T_j, t_p = 80 \mu\text{s}$

