

High-Intensity LED in Plastic T-1³/₄ Package

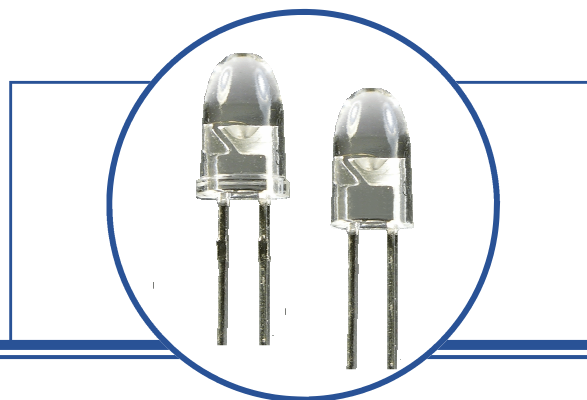

OVLG Series

- Narrow beam angle
- High brightness LED
- Water clear plastic package
- UV resistant epoxy



Each device in the **OVLG Series** is a high intensity LED mounted in a clear plastic T-1³/₄ package. Each device incorporates an integral molded lens that enables a narrow beam angle and provides an even emission pattern. Designed to produce light over a wide range of drive currents, these LEDs are useful in applications that require a higher on-axis brightness than that achievable with standard lamps.

Applications

- Indoor/outdoor applications
- Variable message boards
- Store front signage
- Indicators

Part Number	Material	Emitted Color	Intensity Typ. mcd	Lens Color
OVLGB0C6B9	InGaN	Blue	3800	Water Clear
OVLGC0C6B9		Blue-Green	9800	
OVLGS0C8B9	AlInGaP	Red	8550	
OVLGY0C9B9		Yellow	10300	

AllInGaP Package
Red, Yellow

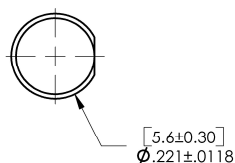

InGaN Package
Blue, Blue-Green

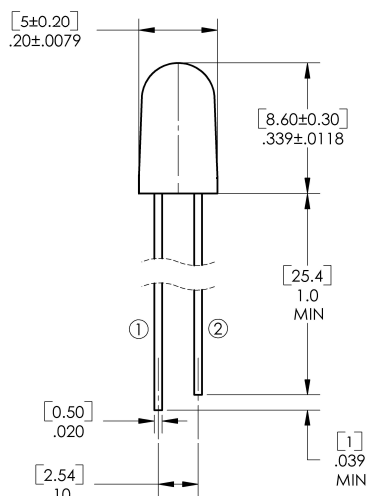
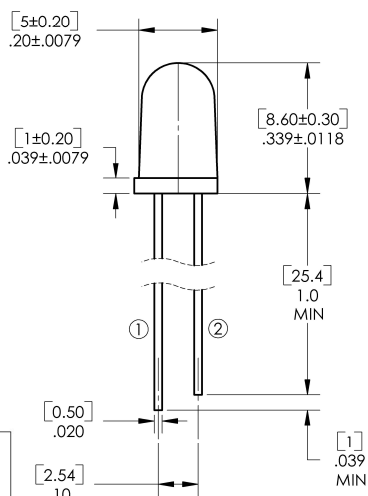
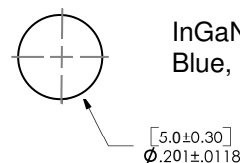

1 ANODE 2 CATHODE
DIMENSIONS ARE IN INCHES
AND [MILLIMETERS]

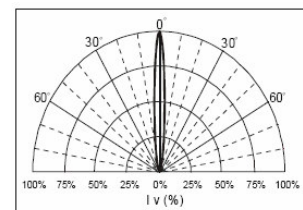

Beam Pattern

DO NOT LOOK DIRECTLY AT LED WITH UNSHIELDED EYES OR DAMAGE TO RETINA MAY OCCUR.



ATTENTION
OBSERVE PRECAUTIONS
ELECTROSTATIC
SENSITIVE DEVICES

OPTEK reserves the right to make changes at any time in order to improve design and to supply the best product possible.

T-1¾ High-Intensity LED

OVLG Series

Absolute Maximum Ratings

T_A = 25°C

Parameter	Red, Yellow	Blue, Blue-Green
DC Forward Current	30mA	20mA
Peak Pulsed Forward Current ¹	100mA	50mA
Power Dissipation	72mW	80mW
Current Linearity vs Ambient Temperature	-0.5mA/°C	-0.2mA/°C
Junction Temperature	125°C	
Reverse Voltage	5V	
Storage Temperature Range	-40° ~ +100 °C	
Operating Temperature Range	-40° ~ +85 °C	
Soldering Temperature ²	260°/5 seconds	

Note:

1. Duty Ratio = 1/10, Pulse Width = 0.1ms
2. 4mm (.157") away from epoxy

Electrical and Optical Characteristics —Blue

T_A = 25°C

SYMBOL	PARAMETER	MIN	TYP	MAX	UNITS	CONDITIONS
I _v	Luminous Intensity	2225	3800	6105	mcd	I _F = 20 mA
V _F	Forward Voltage	2.6	3.4	4.0	V	I _F = 20 mA
I _R	Reverse Current	----	----	50	µA	V _R = 5 V
λ _D	Dominant Wavelength	460	465	475	nm	I _F = 20 mA
Δλ	Spectral Half Width	----	25	----	nm	I _F = 20 mA
2Θ _{1/2} H-H	50% Power Angle	----	6	----	deg	I _F = 20 mA

Electrical and Optical Characteristics —Blue-Green

T_A = 25°C

SYMBOL	PARAMETER	MIN	TYP	MAX	UNITS	CONDITIONS
I _v	Luminous Intensity	6105	9800	16758	mcd	I _F = 20 mA
V _F	Forward Voltage	2.6	3.4	4.0	V	I _F = 20 mA
I _R	Reverse Current	----	----	50	µA	V _R = 5 V
λ _D	Dominant Wavelength	499	505	511	nm	I _F = 20 mA
Δλ	Spectral Half Width	----	25	----	nm	I _F = 20 mA
2Θ _{1/2} H-H	50% Power Angle	----	6	----	deg	I _F = 20 mA

T-1³/₄ High-Intensity LED

OVLG Series

Electrical and Optical Characteristics —Red

T_A = 25°C

SYMBOL	PARAMETER	MIN	TYP	MAX	UNITS	CONDITIONS
I _v	Luminous Intensity	6105	8550	11970	mcd	I _F = 20 mA
V _F	Forward Voltage	1.8	2.0	2.4	V	I _F = 20 mA
I _R	Reverse Current	----	----	10	μA	V _R = 5 V
λ _D	Dominant Wavelength	620	623	630	nm	I _F = 20 mA
Δλ	Spectral Half Width	----	25	----	nm	I _F = 20 mA
2Θ ¹ / ₂ H-H	50% Power Angle	----	6	----	deg	I _F = 20 mA

Electrical and Optical Characteristics —Yellow

T_A = 25°C

SYMBOL	PARAMETER	MIN	TYP	MAX	UNITS	CONDITIONS
I _v	Luminous Intensity	6105	10300	16758	mcd	I _F = 20 mA
V _F	Forward Voltage	1.8	2.0	2.4	V	I _F = 20 mA
I _R	Reverse Current	----	----	10	μA	V _R = 5 V
λ _D	Dominant Wavelength	585	589	595	nm	I _F = 20 mA
Δλ	Spectral Half Width	----	25	----	nm	I _F = 20 mA
2Θ ¹ / ₂ H-H	50% Power Angle	----	6	----	deg	I _F = 20 mA

Standard Bins

Lamps are sorted to luminous intensity (I_v) and dominant wavelength (λ_D) bins shown. Orders may be filled with any or all bins contained as below.

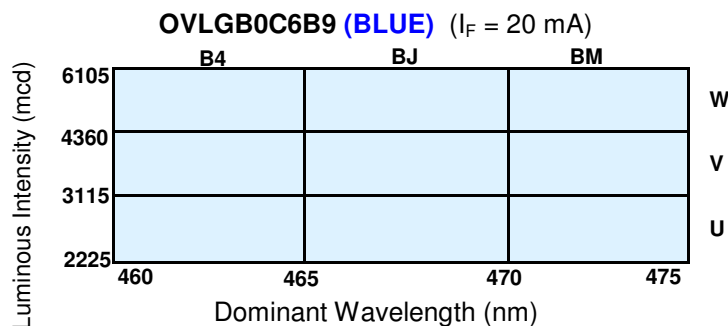

Forward Voltage (V_F)

Rank	H	J	K	L
Voltage (V)	2.6—3.0	3.0—3.3	3.3—3.6	3.6—4.0

Important Notes:

- All ranks will be included per delivery, rank ratio will be based on the chip distribution.
- To designate luminous intensity ranks, please contact OPTEK.

OPTEK reserves the right to make changes at any time in order to improve design and to supply the best product possible.

T-1^{3/4} High-Intensity LED

OVLG Series

Standard Bins

Lamps are sorted to luminous intensity (I_v) and dominant wavelength (λ_D) bins shown. Orders may be filled with any or all bins contained as below.

OVLGC0C6B9 (BLUE-GREEN) ($I_F = 20$ mA)

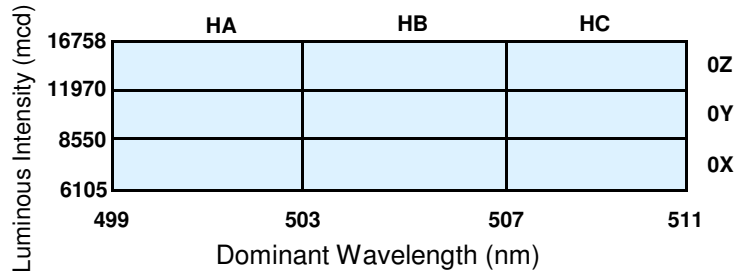

Forward Voltage (V_F)

Rank	H	J	K	L
Voltage (V)	2.6—3.0	3.0—3.3	3.3—3.6	3.6—4.0

OVLGR0C6B9 (RED) ($I_F = 20$ mA)

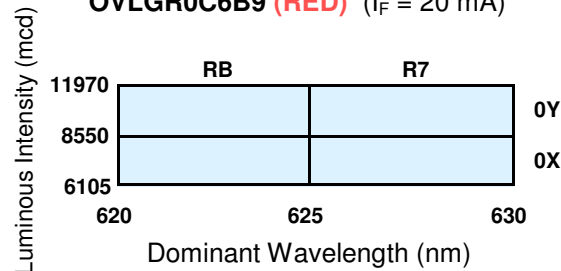

Forward Voltage (V_F)

Rank	G	H	J
Voltage (V)	1.8—2.0	2.0—2.2	2.2—2.4

OVLGY0C6B9 (YELLOW) ($I_F = 20$ mA)

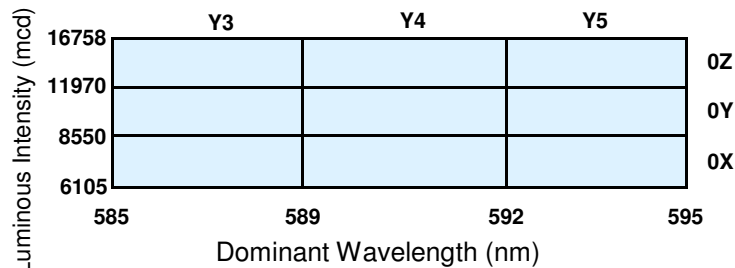

Forward Voltage (V_F)

Rank	G	H	J
Voltage (V)	1.8—2.0	2.0—2.2	2.2—2.4

Important Notes:

1. All ranks will be included per delivery, rank ratio will be based on the chip distribution.
2. To designate luminous intensity ranks, please contact OPTeK.

Typical Electro-Optical Characteristics Curves—Blue

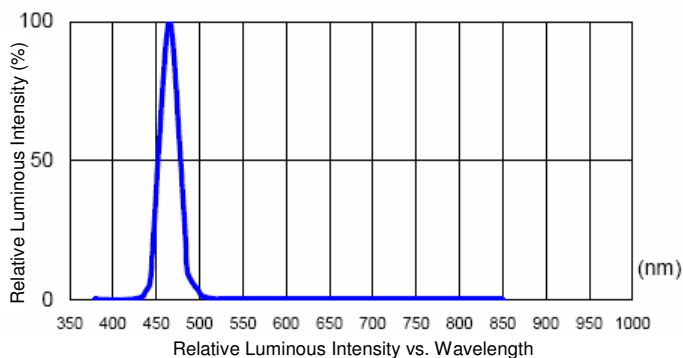
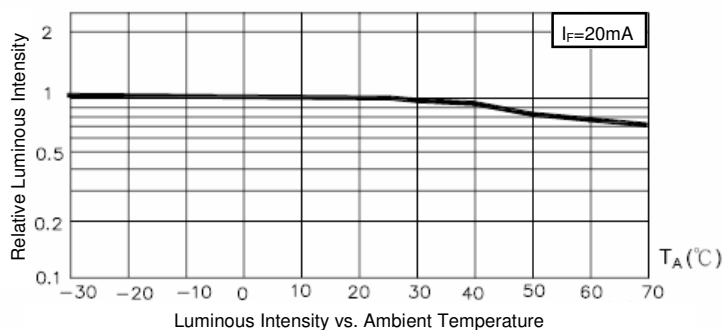
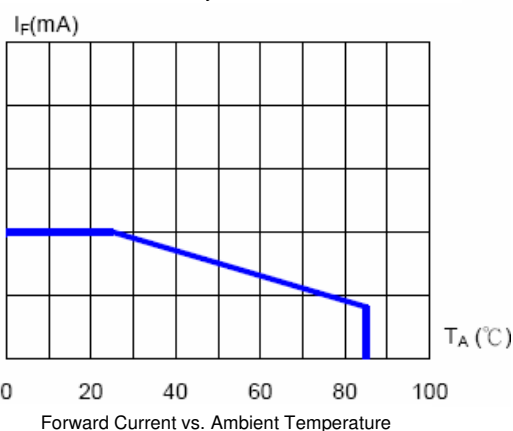
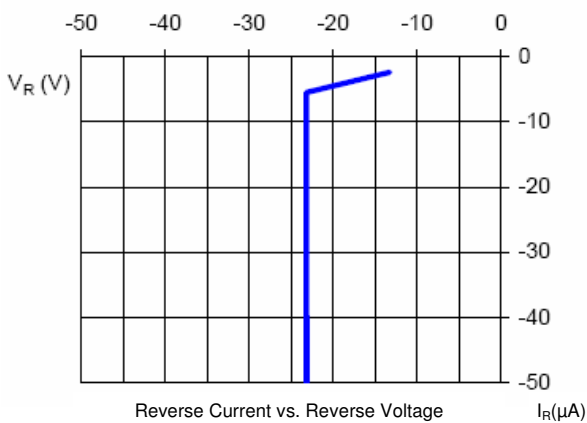
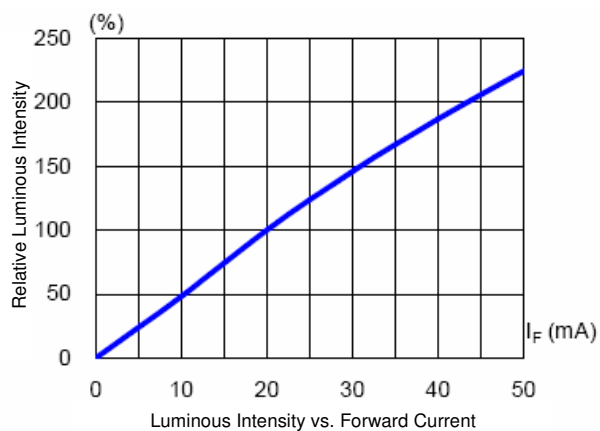
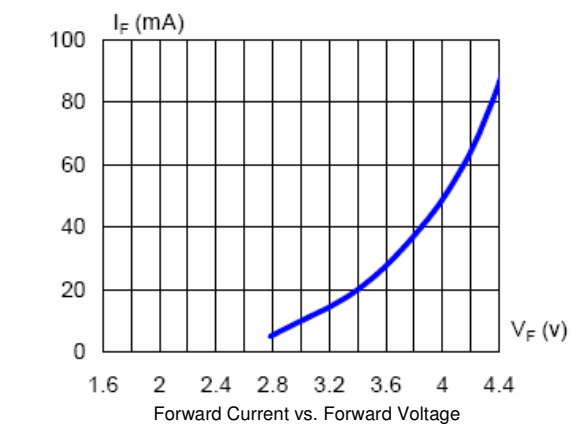

OPTEK reserves the right to make changes at any time in order to improve design and to supply the best product possible.

Typical Electro-Optical Characteristics Curves—Blue-Green

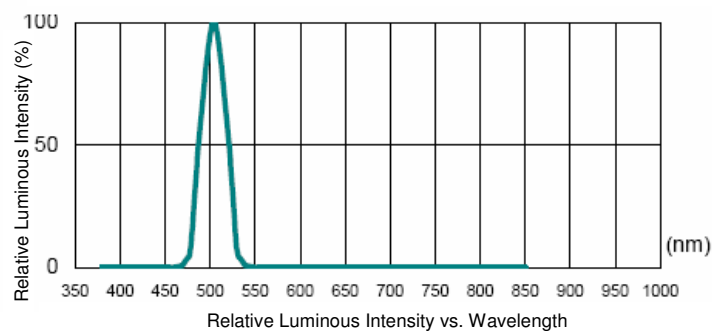
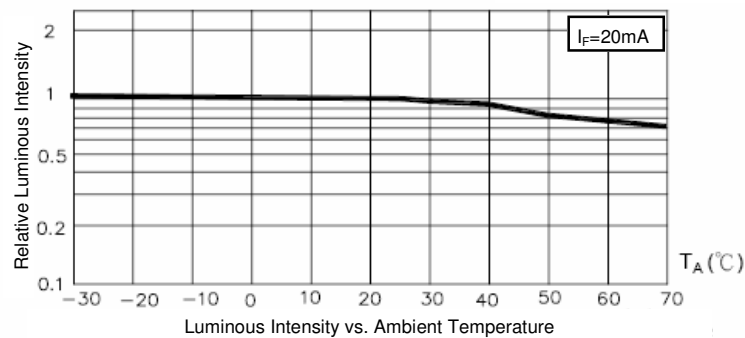
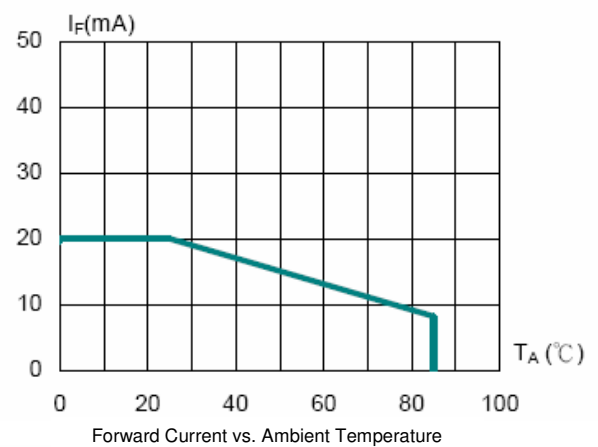
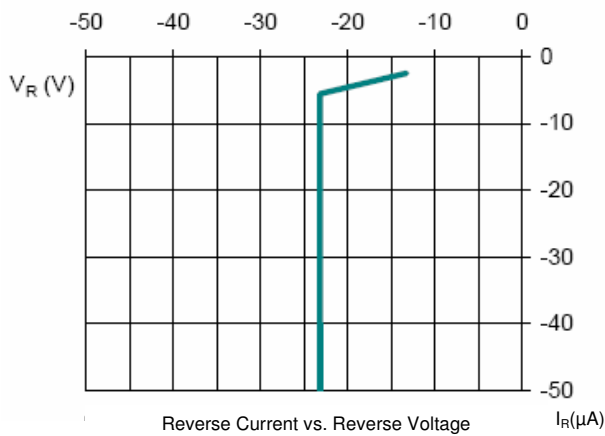
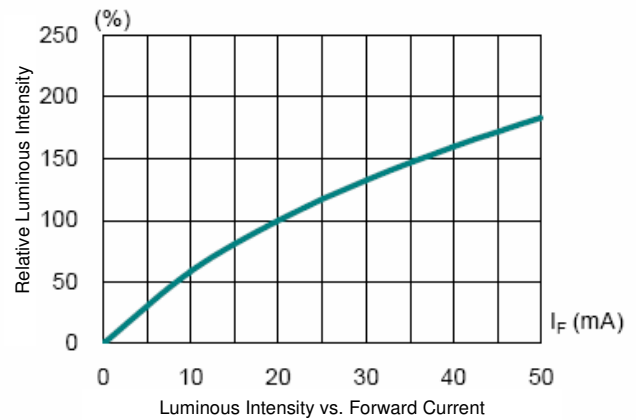
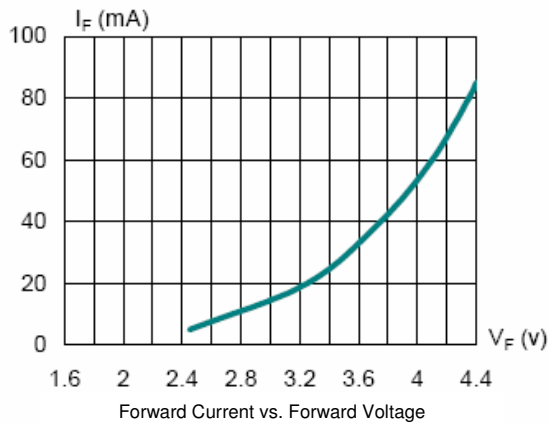

T-1 $\frac{3}{4}$ High-Intensity LED

OVLG Series

Typical Electro-Optical Characteristics Curves—Red

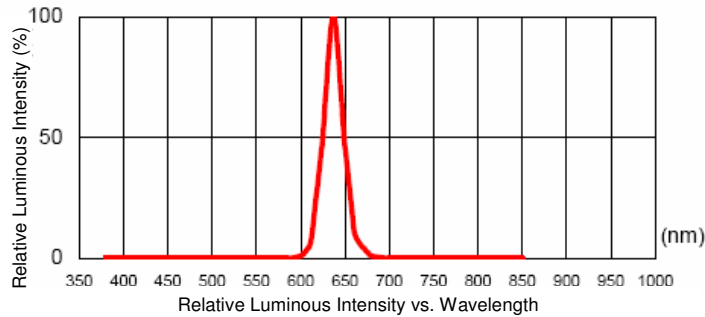
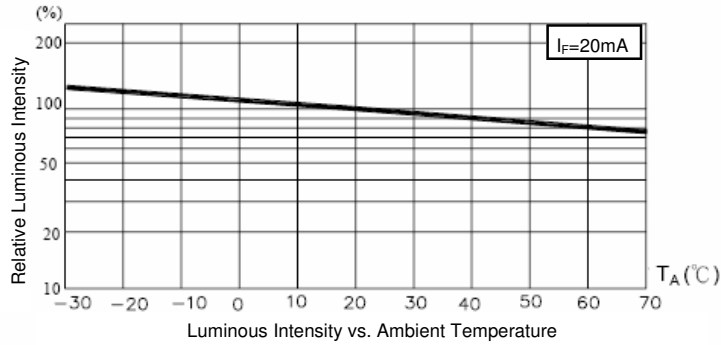
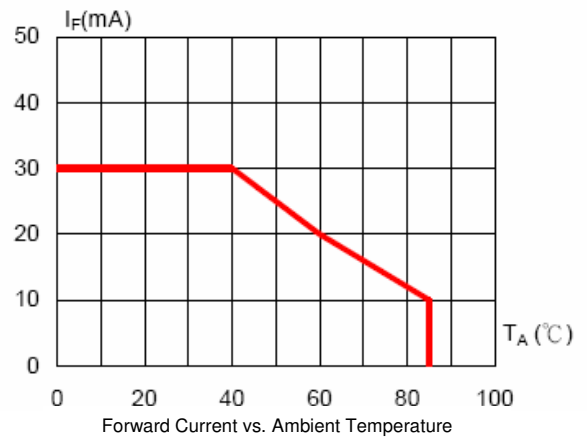
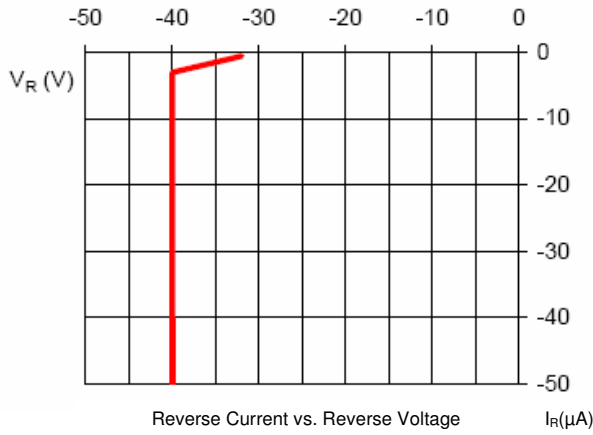
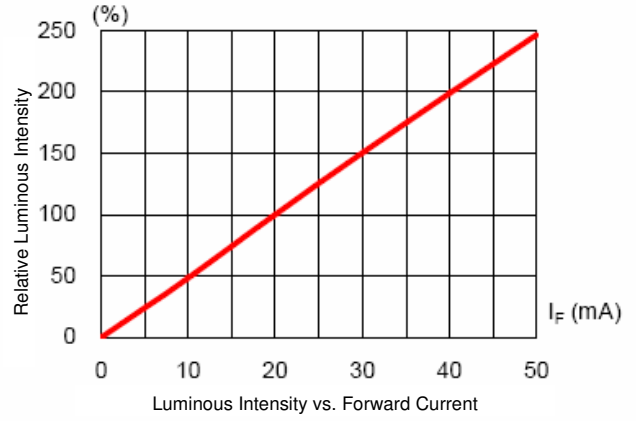
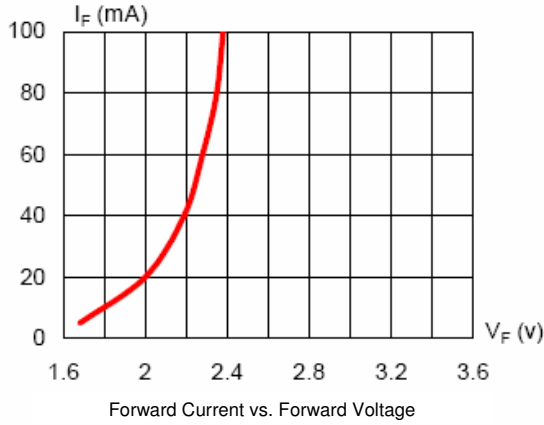

OPTEK reserves the right to make changes at any time in order to improve design and to supply the best product possible.

T-1³/₄ High-Intensity LED

OVLG Series

Typical Electro-Optical Characteristics Curves—Yellow

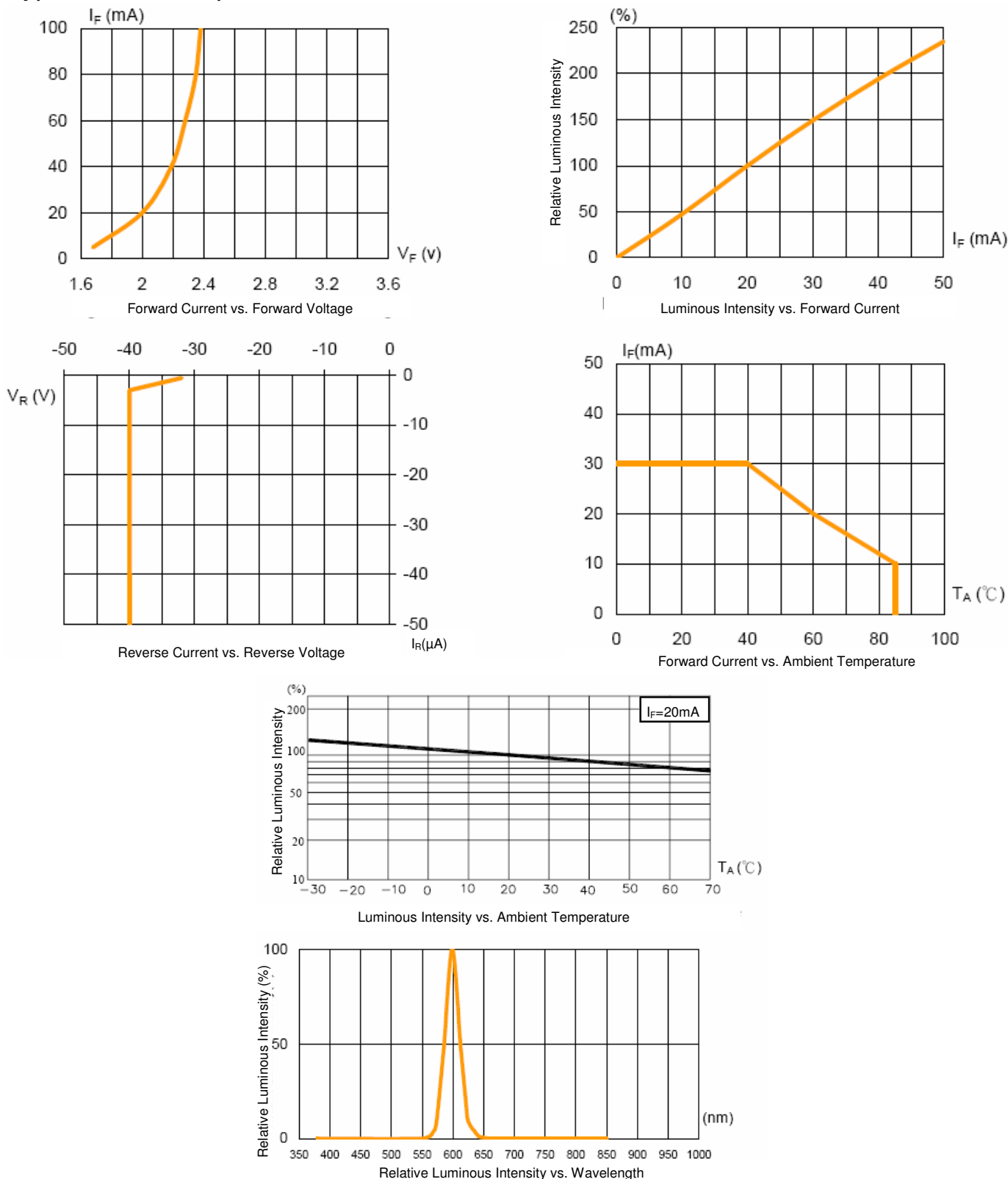

T-1 $\frac{3}{4}$ High-Intensity LED

OVLG Series

Packing Information: Available in bulk or reel

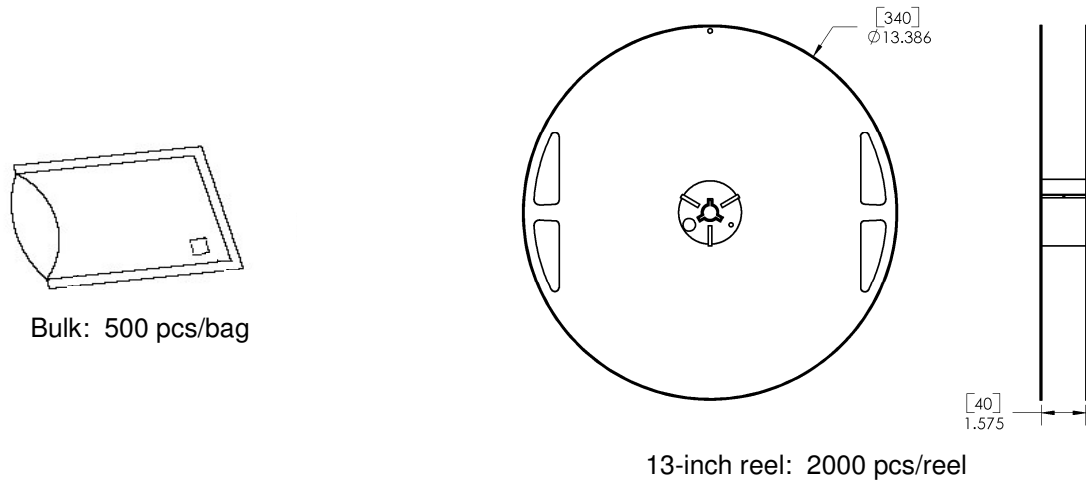

Carrier Tape Dimensions: Loaded quantity 2000 pieces per reel

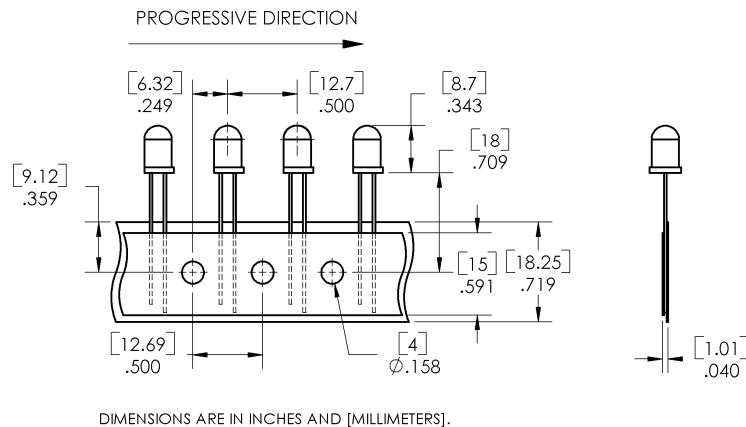

Moisture Resistant Packaging

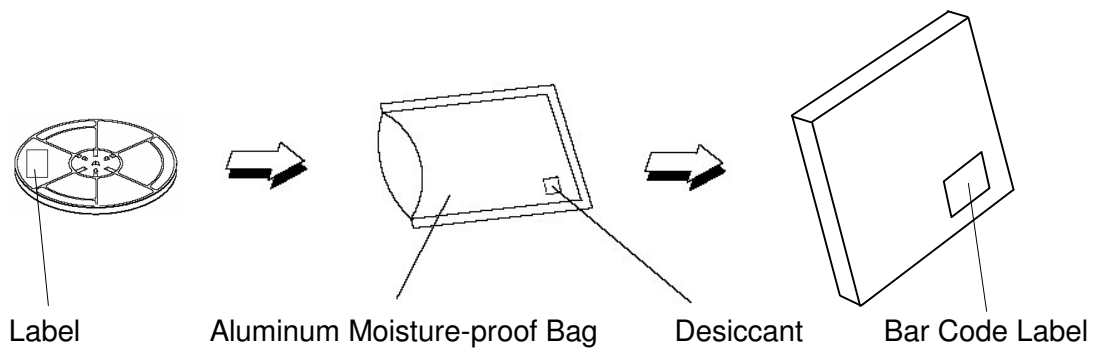

OPTEK reserves the right to make changes at any time in order to improve design and to supply the best product possible.

T-1^{3/4} High-Intensity LED

OVLG Series

Reliability Test

LED lamps are checked by reliability tests based on MIL standards.

1. Test Conditions, Acceptable Criteria & Results

Classification	Test Item	Standard Test Method	Test Conditions	Duration	Unit	Acc / Rej Criteria	Result
Life Test	Operation Life Test (OLT)	MIL-STD-750D Method 1026.3	$T_A=25^{\circ}\text{C}$, $I_F=30\text{mA}$ *	1000 Hrs	100	0 / 1	Pass
Environment Test	High Temperature Storage (HTS)	MIL-STD-750D Method 1032.1	$T_A=100^{\circ}\text{C}$	1000 Hrs	100	0 / 1	Pass
	Low Temperature Storage (LTS)	MIL-STD-750D Method 1032.1	$T_A=-40^{\circ}\text{C}$	1000 Hrs	100	0 / 1	Pass
	Temp. & Humidity with Bias (THB)	MIL-STD-750D Method 103B	$T_A=85^{\circ}\text{C}$, $\text{Rh}=85\%$ $I_F=20\text{mA}$ **	500 Hrs	100	0 / 1	Pass
	Thermal Shock Test (TST)	MIL-STD-750D Method 1056.1	0°C ~ 100°C 2min 2min	100 cycles	100	0 / 1	Pass
	Temperature Cycling Test (TCT)	MIL-STD-750D Method 1051.5	-40°C ~ 25°C ~ 100°C ~ 25°C 30min 5min 30min 5min	100 cycles	100	0 / 1	Pass
Mechanical Test	Solderability	MIL-STD-750D Method 2026.4	$235\pm 5^{\circ}\text{C}$, 5 sec	1 time	20	0 / 1	Pass
	Resistance to Soldering Heat	MIL-STD-750D Method 2031.1	$260\pm 5^{\circ}\text{C}$, 10 sec	1 time	20	0 / 1	Pass
	Lead Integrity	MIL-STD-750D Method 2036.3	Load 2.5N (0.25kgf) 0° ~ 90° ~ 0° , bend	3 times	20	0 / 1	Pass

Remark : (*) $I_F=30\text{mA}$ for AlInGaP chip ; $I_F=20\text{mA}$ for InGaN chip

(**) $I_F=20\text{mA}$ for AlInGaP chip ; $I_F=10\text{mA}$ for InGaN chip

2. Failure Criteria ($T_A=25^{\circ}\text{C}$):

Test Item	Symbol	Test Conditions	Criteria for Judgment	
			Min.	Max.
Luminous Intensity	I_V	$I_F=20\text{mA}$	$\text{LSL}\times 0.7$ **	
Voltage (Forward)	V_F	$I_F=20\text{mA}$		$\text{USL}\times 1.1$ *

(*) USL : Upper Standard Level , (**) LSL : Lower Standard Level