

Title		
Size	Number	Revision
B		
Date:	17/11/2006	Sheet of
File:	D:\Elec\jalim_ext\SchDoc	Drawn By:

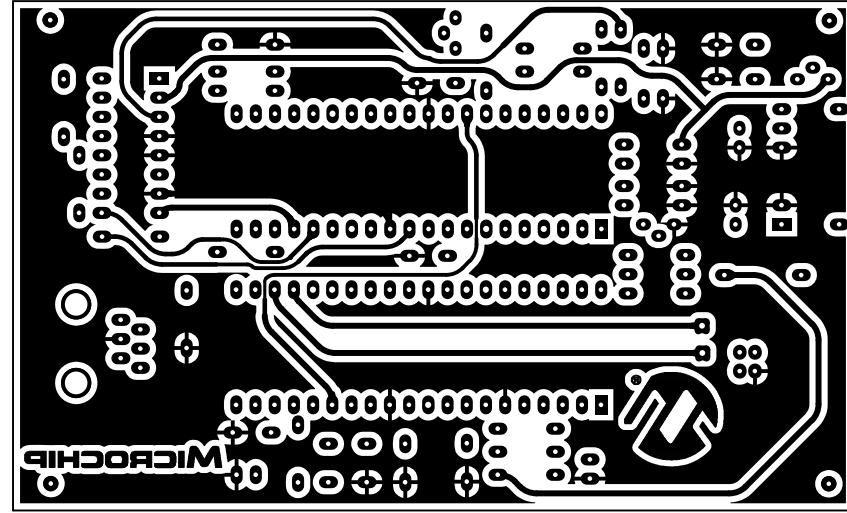

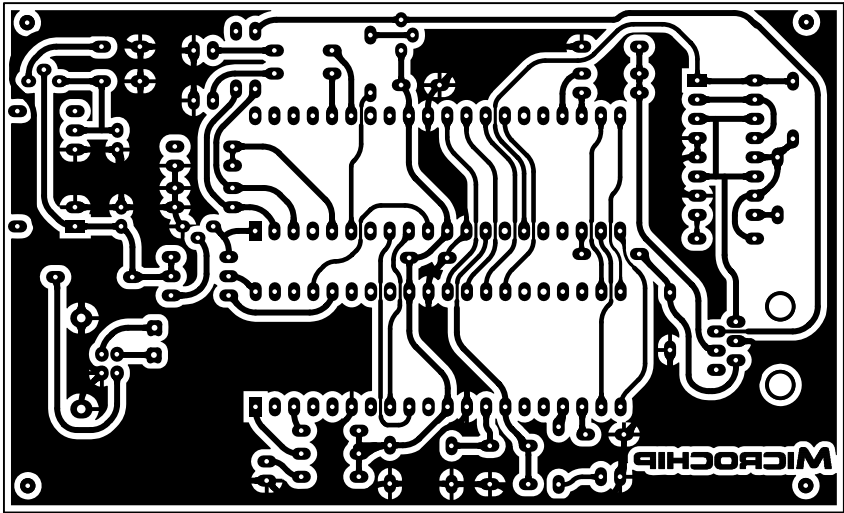

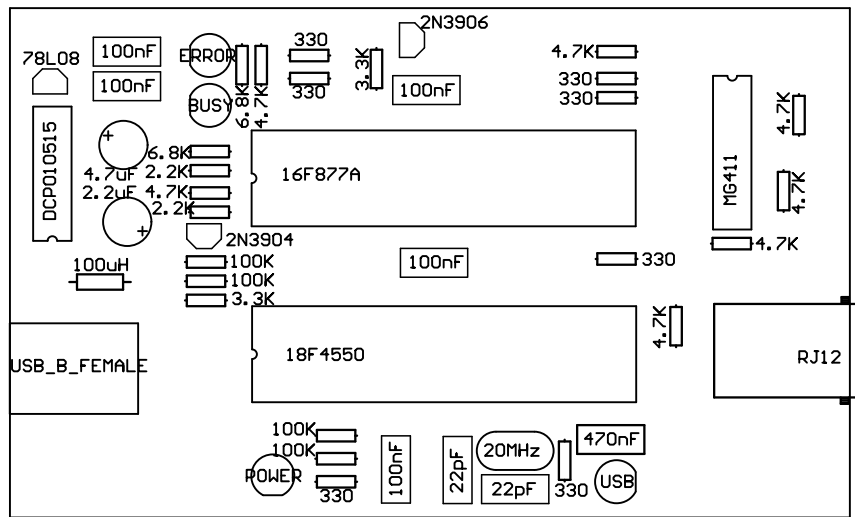

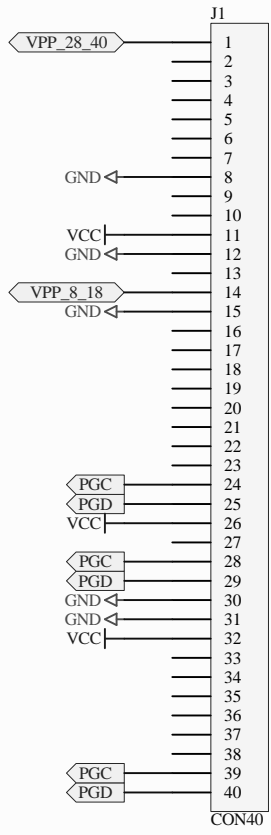
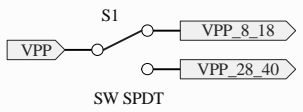
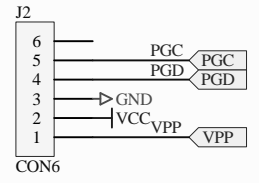
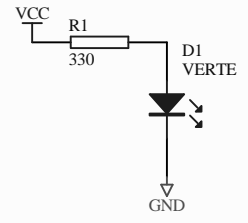

Title Programmer Universal Module			Lycée R POINCARE * * *	
Size: A4	Number: *	Revision: *		
Date: 08/01/2007	Time: 12:55:10	Sheet 1 of 1		

