

AIZ Series Passive 10-Tap DIP/SMD Delay Modules

- Low Profile 14-Pin Package
Two Surface Mount Versions
- Low Distortion LC Network
- 10 Equal Delay Taps, Variety of Footprints
- Fast Rise Time -- $BW \approx 0.35 / t_r$
- Standard Impedances: 50 - 75 - 100 - 200 Ω
- Stable Delay vs. Temperature: 100 ppm/ $^{\circ}C$
- Operating Temperature Range -55 $^{\circ}C$ to +125 $^{\circ}C$

Operating Specifications - Passive Delay Lines

Pulse Overshoot (Pos) 5% to 10%, typical
 Pulse Distortion (S) 3% typical
 Working Voltage 25 VDC maximum
 Dielectric Strength 100VDC minimum
 Insulation Resistance 1,000 M Ω min. @ 100VDC
 Temperature Coefficient 70 ppm/ $^{\circ}C$, typical
 Bandwidth (f_c) 0.35/ t_r approx.
 Operating Temperature Range -55 $^{\circ}$ to +125 $^{\circ}C$
 Storage Temperature Range -65 $^{\circ}$ to +150 $^{\circ}C$

Electrical Specifications at 25 $^{\circ}C$ ^{1,2,3} Note: For SMD Package add "G" of "J" as below to P/N in Table

Delay Tolerances		50 Ohm Part Number	Rise Time (ns)	DCR max. (Ohms)	75 Ohm Part Number	Rise Time (ns)	DCR max. (Ohms)	100 Ohm Part Number	Rise Time (ns)	DCR max. (Ohms)	200 Ohm Part Number	Rise Time (ns)	DCR max. (Ohms)
Total (ns)	Tap-to-Tap (ns)												
5.0 ± 0.5	0.5 ± 0.2	AIZ-55	1.5	0.8	AIZ-57	1.5	0.8	AIZ-51	1.5	0.8	AIZ-52	1.5	0.8
7.5 ± 0.5	0.75 ± 0.3	AIZ-7P55	1.8	0.8	AIZ-7P57	1.8	1.1	AIZ-7P51	1.8	0.8	AIZ-7P52	1.8	0.8
10 ± 1.0	1.0 ± 0.4	AIZ-105	2.0	.80	AIZ-107	2.0	1.1	AIZ-101	2.0	1.2	AIZ-102	2.0	1.7
15 ± 1.0	1.5 ± 0.5	AIZ-155	3.0	1.0	AIZ-157	3.0	1.3	AIZ-151	3.0	1.4	AIZ-152	3.0	1.9
20 ± 1.0	2.0 ± 0.5	AIZ-205	4.0	1.2	AIZ-207	4.0	1.5	AIZ-201	4.0	1.6	AIZ-202	4.0	2.4
25 ± 1.25	2.5 ± 0.5	AIZ-255	5.0	1.3	AIZ-257	5.0	1.6	AIZ-251	5.0	1.8	AIZ-252	5.0	3.4
30 ± 1.5	3.0 ± 0.6	AIZ-305	6.0	1.4	AIZ-307	6.0	1.9	AIZ-301	6.0	2.0	AIZ-302	6.0	3.7
35 ± 1.75	3.5 ± 1.0	AIZ-355	7.0	1.5	AIZ-357	7.0	2.6	AIZ-351	7.0	2.9	AIZ-352	7.0	4.0
40 ± 2.0	4.0 ± 1.0	AIZ-405	8.0	1.6	AIZ-407	8.0	2.9	AIZ-401	8.0	3.1	AIZ-402	8.0	4.3
50 ± 2.5	5.0 ± 1.0	AIZ-505	10.0	1.8	AIZ-507	10.0	3.2	AIZ-501	10.0	3.5	AIZ-502	10.0	5.6
60 ± 3.0	6.0 ± 1.5	AIZ-605	12.0	2.0	AIZ-607	12.0	3.5	AIZ-601	12.0	3.8	AIZ-602	12.0	6.1
75 ± 3.75	7.5 ± 1.5	AIZ-755	15.0	2.9	AIZ-757	15.0	4.5	AIZ-751	15.0	4.8	AIZ-752	15.0	6.8
80 ± 4.0	8.0 ± 1.8	AIZ-805	16.0	3.0	AIZ-807	16.0	4.8	AIZ-801	16.0	5.0	AIZ-802	16.0	7.0
100 ± 5.0	10.0 ± 2.0	AIZ-1005	20.0	3.4	AIZ-1007	20.0	4.9	AIZ-1001	20.0	5.6	AIZ-1002	20.0	8.0
120 ± 6.0	12.0 ± 2.5	AIZ-1205	24.0	3.7	AIZ-1207	24.0	5.5	AIZ-1201	24.0	6.0	AIZ-1202	25.0	12.0
125 ± 6.25	12.5 ± 2.5	AIZ-1255	25.0	3.9	AIZ-1257	25.0	5.6	AIZ-1251	25.0	6.3	AIZ-1252	26.0	12.3
150 ± 7.5	15.0 ± 3.0	AIZ-1505	30.0	4.8	AIZ-1507	30.0	6.3	AIZ-1501	30.0	6.8	AIZ-1502	32.0	13.5

1. Rise Times are measured from 10% to 90% points.
2. Delay Times measured at 50% point of leading edge.
3. Output (100% Tap) terminated to ground through $R_L = Z_0$

OPTIONAL SCHEMATICS: As below, with similar electricals per table these passive delays are available in range of schematic styles (Contact factory for others not shown).

AIZ Style Schematic Most Popular Footprint

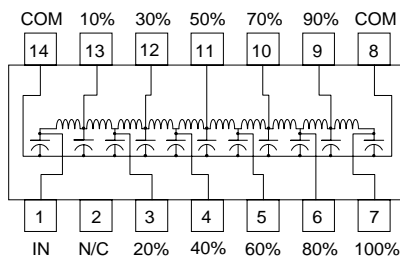

AIY Style Schematic Per table above, substitute AIY for AIZ in P/N

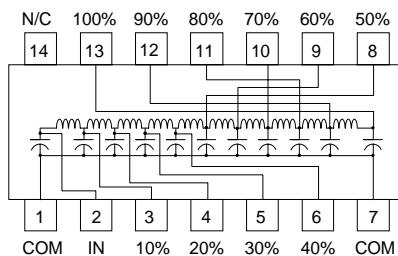

AIU Style Schematic Per table above, substitute AIU for AIZ in P/N

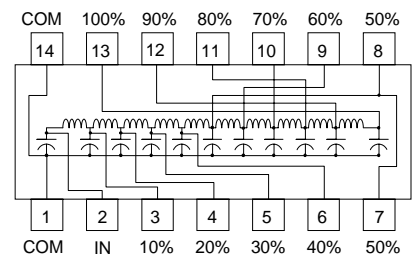

14-PIN PACKAGE OPTIONS: See Drawings on Page 2.
 Available as Thru-hole (default) or SMD versions.
 Gull wing SMD add "G" to end of P/N per table.
 J-Bend SMD add "J" to end of P/N per table.

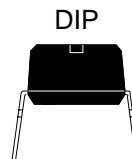

Specifications subject to change without notice.

For other values & Custom Designs, contact factory.

AIZ 9901

14-Pin Low Profile DIP/SMD Package Dimensions in Inches (mm)

14-Pin DIP, "Thru-hole" is Default package style per Table on Page 1.

Example P/N: AIZ-101
AIY-205
AIU-1507

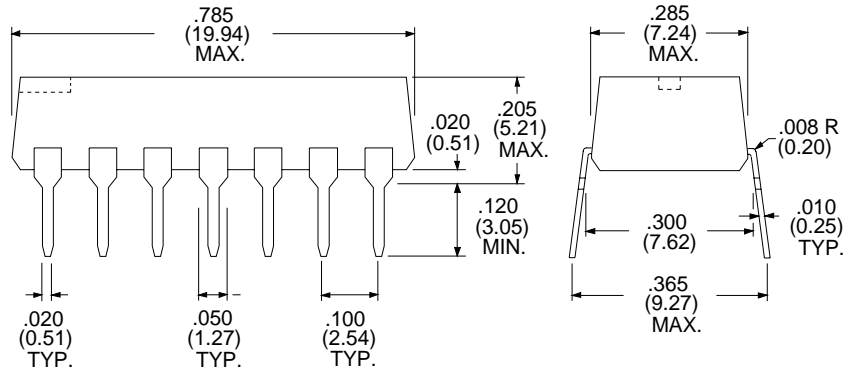

14-Pin Gull wing SMD. To Specify G-SMD, add "G" to end of P/N per Table on Page 1.

Example P/N: AIZ-101G
AIY-205G
AIU-1507G

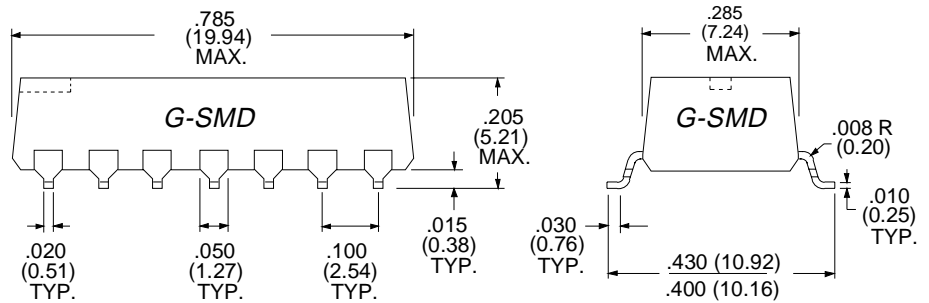

14-Pin J-Bend SMD. To Specify J-SMD, add "J" to end of P/N per Table on Page 1.

Example P/N: AIZ-101J
AIY-205J
AIU-1507J

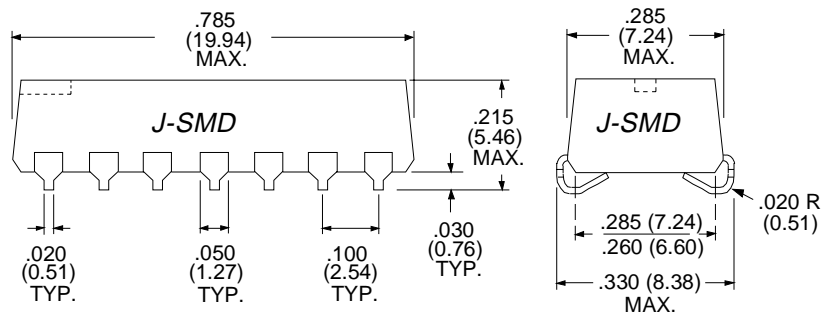

OPTIONAL SCHEMATICS: As below, with similar electricals per table these passive delays are available in range of schematic styles (Contact factory for other 14-Pin Schematic Styles not shown).

AIZ Style Schematic
Most Popular Footprint

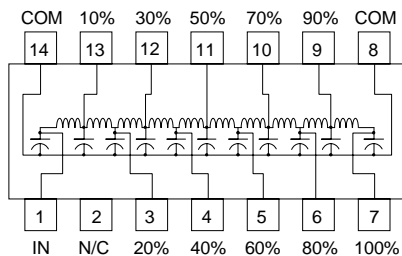

AIY Style Schematic
Per table above, substitute AIY for AIZ in P/N

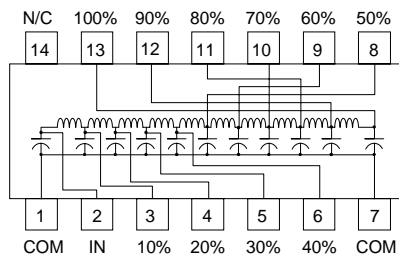

AIU Style Schematic
Per table above, substitute AIU for AIZ in P/N

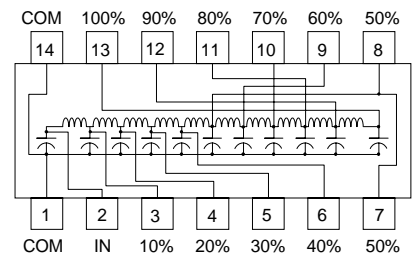

Specifications subject to change without notice.

For other values & Custom Designs, contact factory.

AIZ 9901