

Features

- Schottky Diode Embedded, Saving Cost and Space
- Low Start-up Voltage (0.9V)
- High Efficiency up to 88%
- Low Quiescent Current
- Low Ripple and Noise
- Available Output Voltage: 2.0V, 2.7V, 2.8V, 3.0V, 3.3V, 3.8V and 5.0V
- Space Saving Packages: SOT-89, SOT-23
- Pb-Free Package

Applications

- Pagers
- Cameras
- Wireless Microphones
- Pocket Organizers
- Battery Backup Suppliers
- Portable Instruments

General Description

The PAM2400 is a high efficiency step-up DC/DC converter, delivering a fixed output voltage of 2.0V, 2.7V, 2.8V, 3.0V, 3.3V, 3.8V or 5.0V. The device starts up with an input voltage as low as 0.9V at 1mA load. The Pulse Frequency Modulation (PFM) scheme provides optimized performance for applications with light load and low input voltages.

The PAM2400 employs a built-in synchronous rectifier, instead of requiring an external Schottky diode, so that to improve system efficiency and save system cost and PCB area.

The internal PFM control circuit operates at constant switching frequency of 100KHz. Only three external components are required. The space saving SOT-89 and SOT-23 packages make the PAM2400 ideal for space conscious applications.

Typical Application

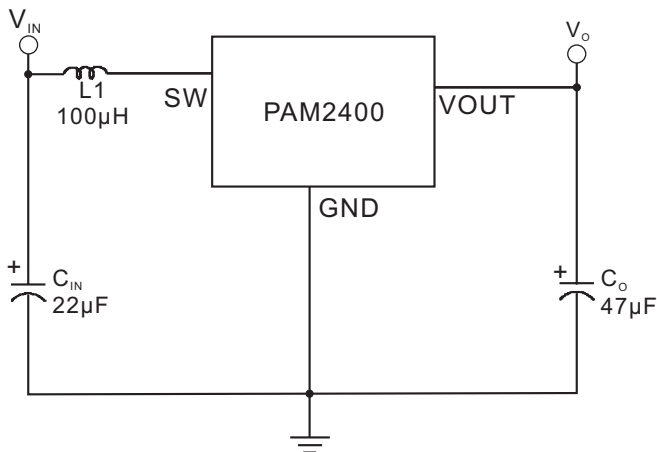

Block Diagram

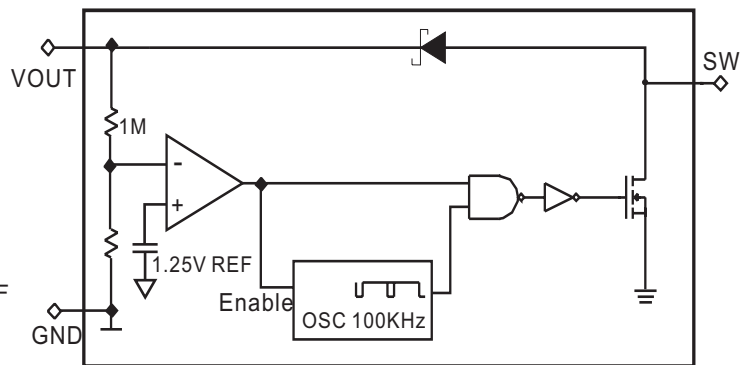

Pin Configuration & Marking Information

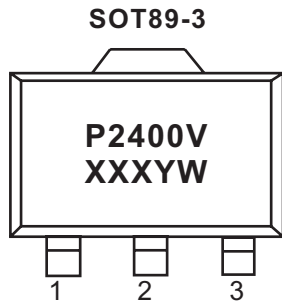

V: Voltage Code
 X: Internal Code
 Y: Year
 W: Week

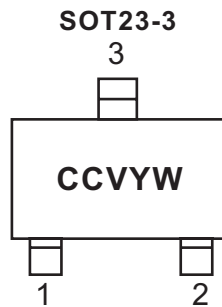

CC: Product Code of PAM2400
 V: Voltage Code
 Y: Year
 W: Week

Pin Number	Name	Function
1	GND	Ground
2	VOUT	Output
3	SW	Switch Pin

Absolute Maximum Ratings

These are stress ratings only and functional operation is not implied. Exposure to absolute maximum ratings for prolonged time periods may affect device reliability. All voltages are with respect to ground.

Supply Voltage.....	6.0V	Operating Temperature Range.....	-40°C to 85°C
SW pin Voltage.....	6.0V	Storage Temperature Range.....	-65°C to 150°C
SW pin Switch Current.....	0.4A	Lead Temperature (Soldering 5 Sec.).....	300°C

Thermal Information

Parameter	Symbol	Package	Maximum	Unit
Thermal Resistance (Junction to Case)	θ_{JC}	SOT89-3	45	°C/W
		SOT-23	130	
Thermal Resistance (Junction to Ambient)	θ_{JA}	SOT89-3	160	°C/W
		SOT-23	250	
Internal Power Dissipation	P_D	SOT89-3	550	mW
		SOT-23	400	



Electrical Characteristic

$C_{IN}=22\mu F, C_O=47\mu F, T_A=25^\circ C$, unless otherwise noted.

Parameter	Symbol	Test Conditions	MIN	TYP	MAX	UNIX
Output Voltage Accuracy		$V_{IN}=1.5V, I_O=1mA$	-3		+3	%
Input Voltage	V_{IN}				5.5	V
Start-Up Voltage	V_{START}	$I_O=1mA$		0.9	1.0	V
Hold-on Voltage	V_{HOLD}	$I_O=0mA, V_{IN}=2V$ to 0V		0.4	0.6	V
Supply Current (Vo pin)	I_{DD1}	$V_O=V_O \times 1.05$		8.5	12	μA
	I_{DD2}	$V_O=V_O \times 0.95$		33		μA
No-Load Input Current	I_{IN}	$I_O=0mA,$ $V_{IN}=1.5V$		19		μA
				23		
				25		
				26		
				29		
				34		
				45		
SW Leakage Current		$V_{SW}=5V, V_{IN}=V_O+0.5V$			1.0	μA
SW Switch-On Resistance	R_{ON}	$I_{sw}=50mA$		1.0		Ω
Oscillator Duty Cycle	DC	$V_{IN}=V_O \times 90\%$	70	80	90	%
Oscillator Frequency	f_{OSC}	Current Limit Appears	70	100	130	kHz
Efficiency (Note 2)	η	Peak value		85		%

Note 1: V_O means the nominal output voltage

Note 2: Refer to "Efficiency vs Output Current" curve

Typical Performance Characteristics

$C_{IN}=22\mu F, C_O=47\mu F, T_A=25^\circ C$, unless otherwise noted.

$V_O=2.0V$

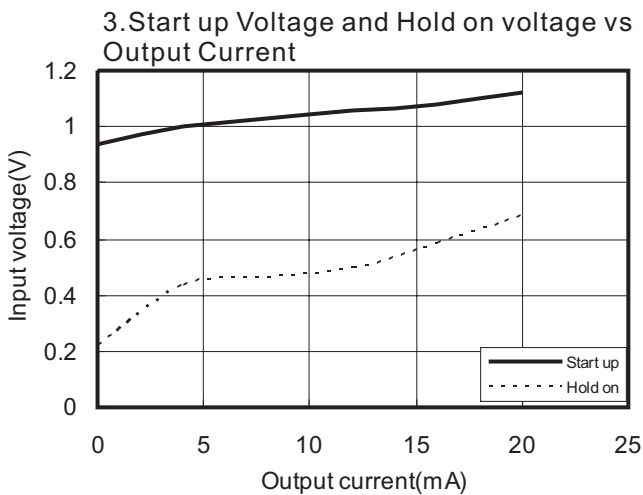
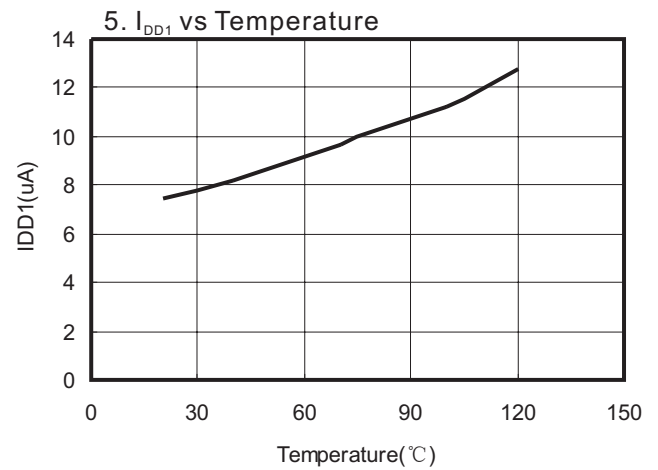
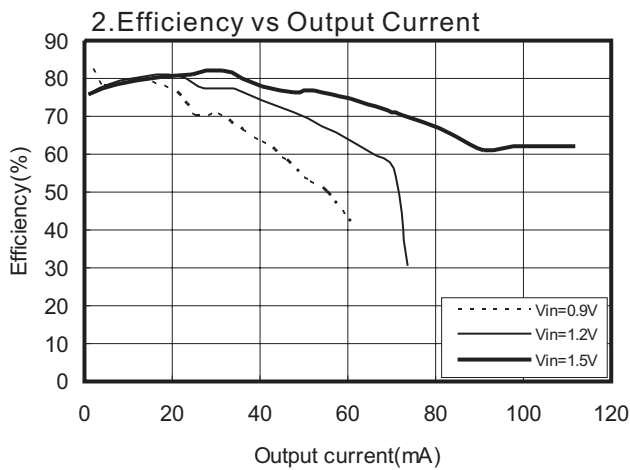
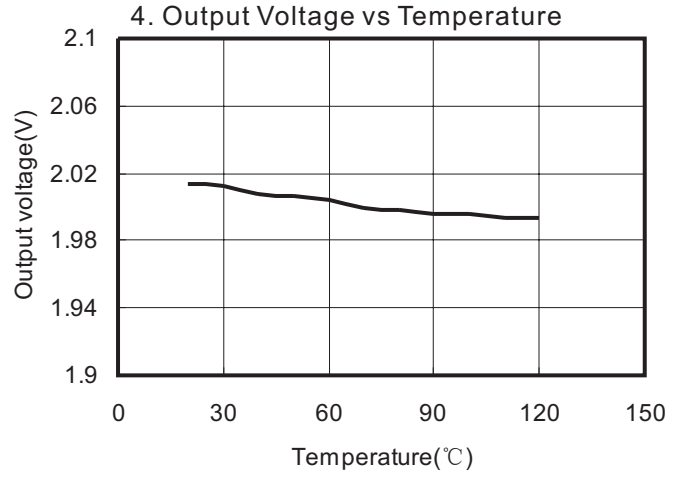
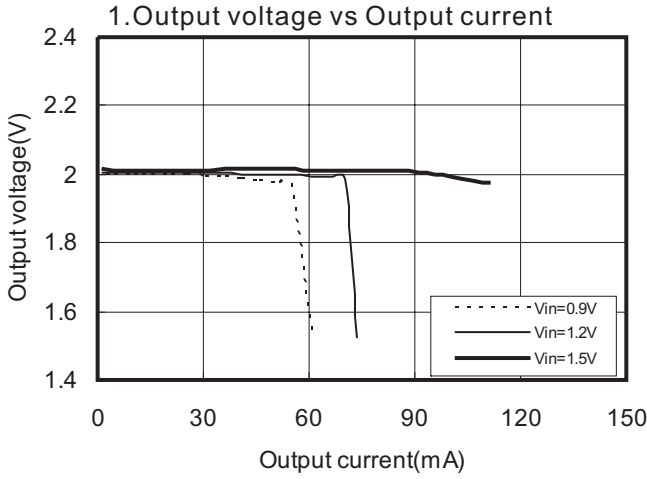

Typical Performance Characteristics (continued)

$C_{IN}=22\mu F, C_O=47\mu F, T_A=25^\circ C$, unless otherwise noted.

$V_O=2.7V$

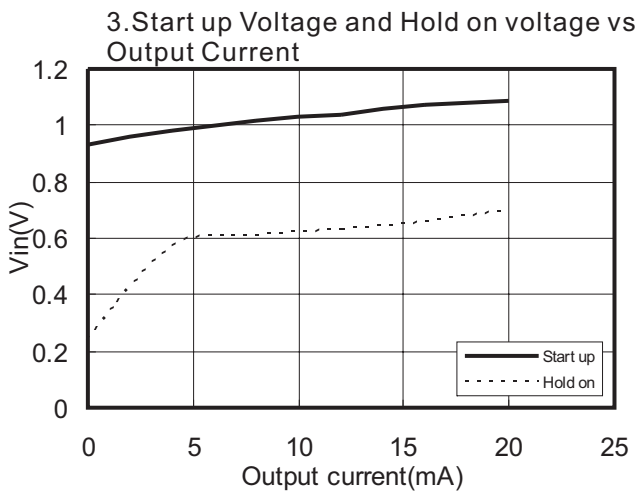
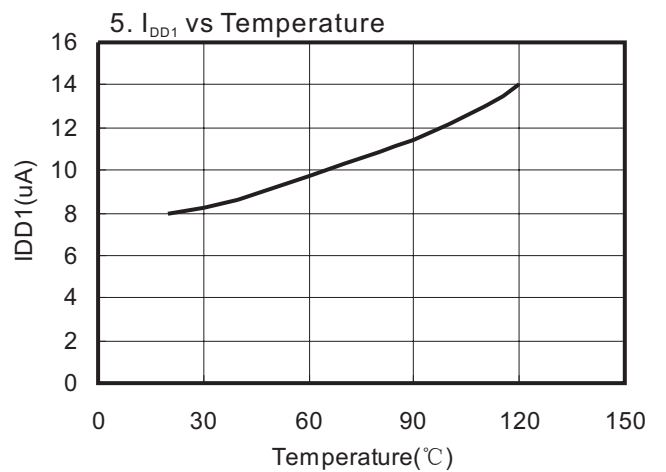
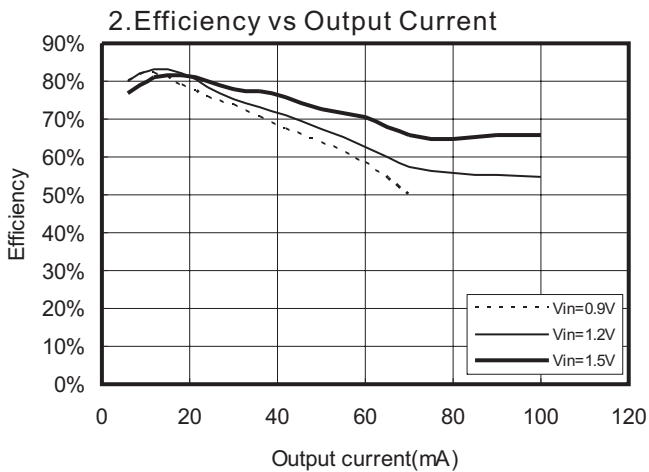
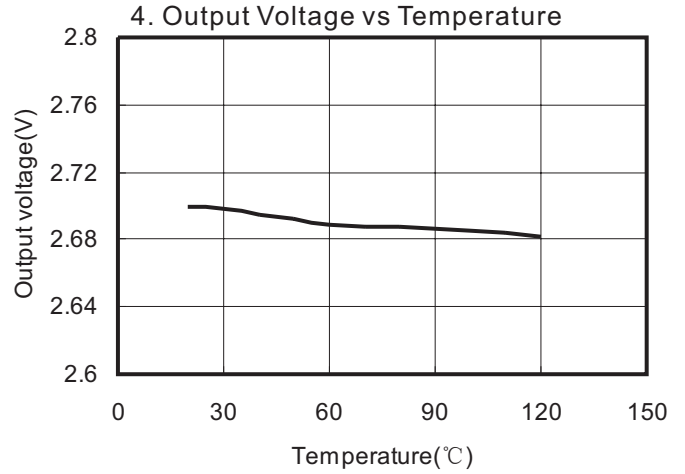
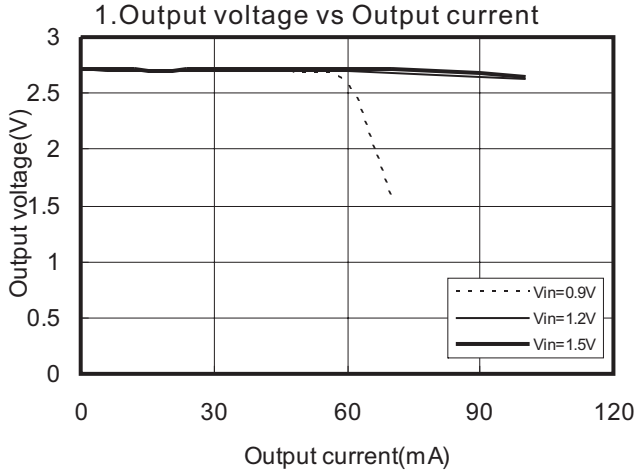

Typical Performance Characteristics (continued)

$C_{IN}=22\mu F, C_o=47\mu F, T_A=25^\circ C$, unless otherwise noted.

$V_o=2.8V$

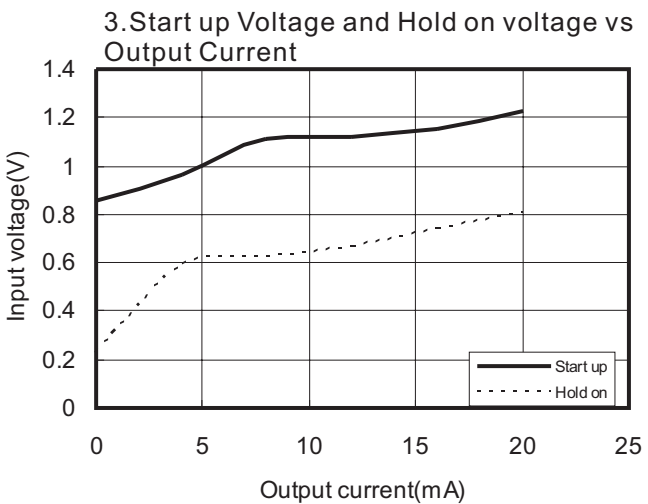
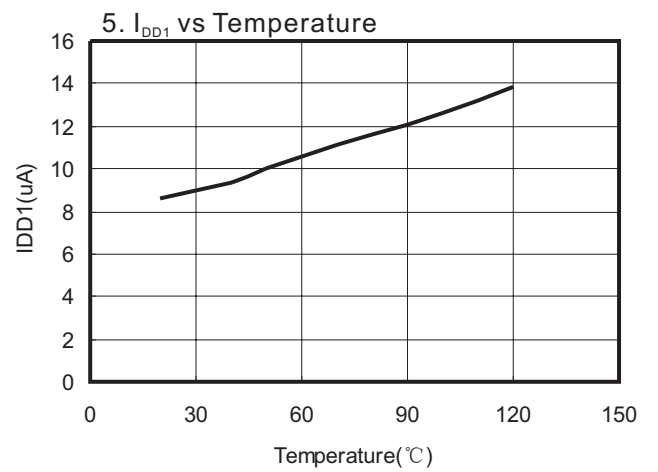
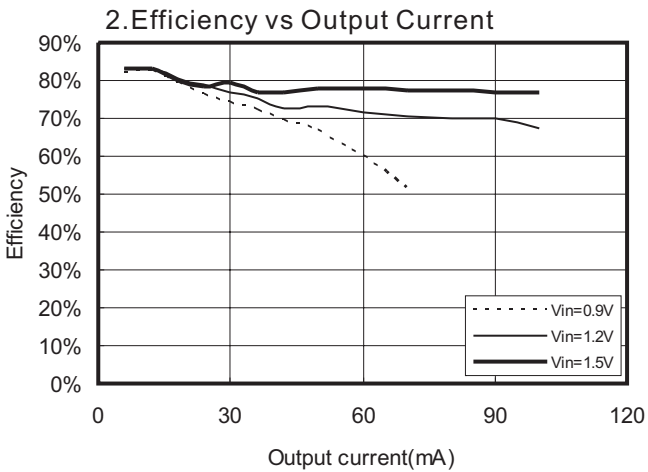
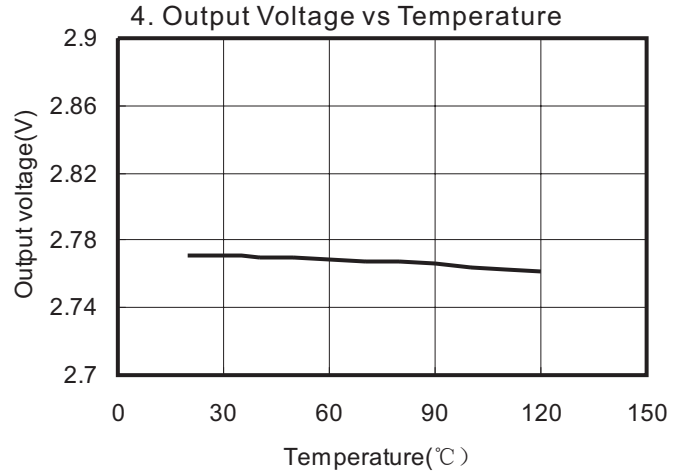
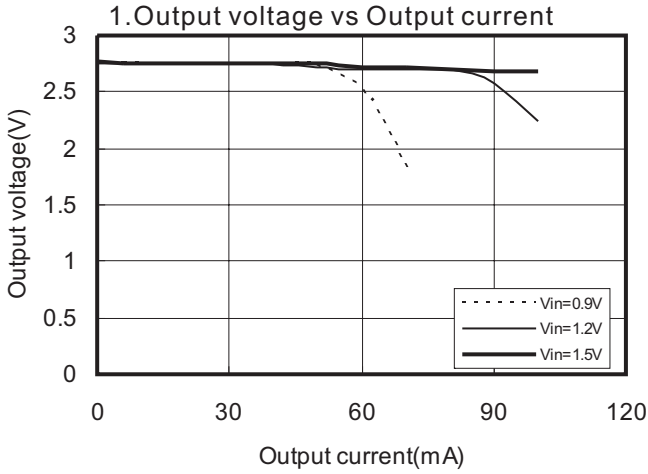

Typical Performance Characteristics (continued)

$C_{IN}=22\mu F, C_O=47\mu F, T_A=25^\circ C$, unless otherwise noted.

$V_O=3.0V$

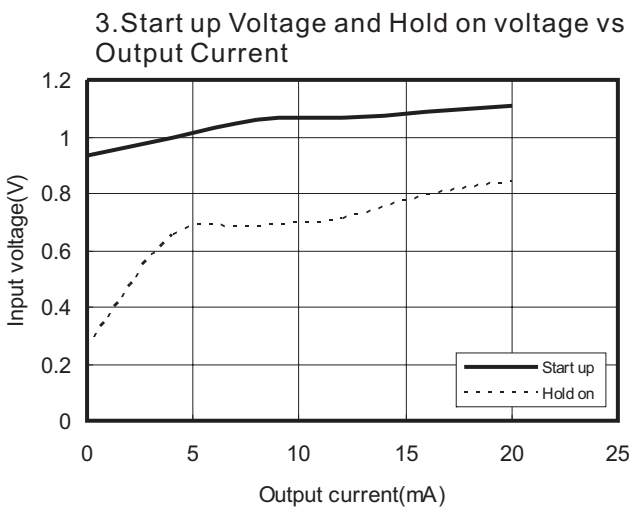
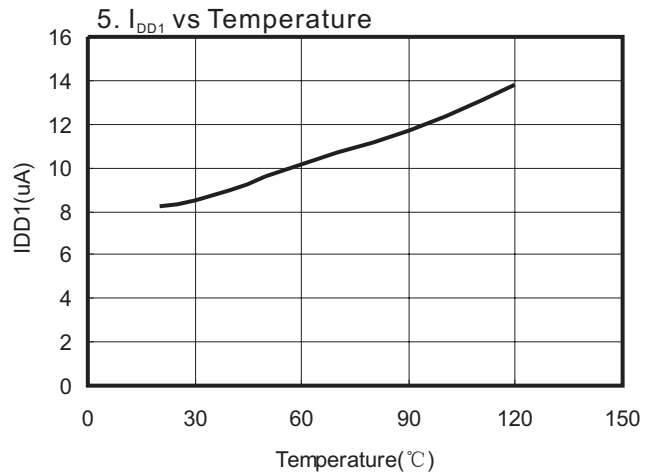
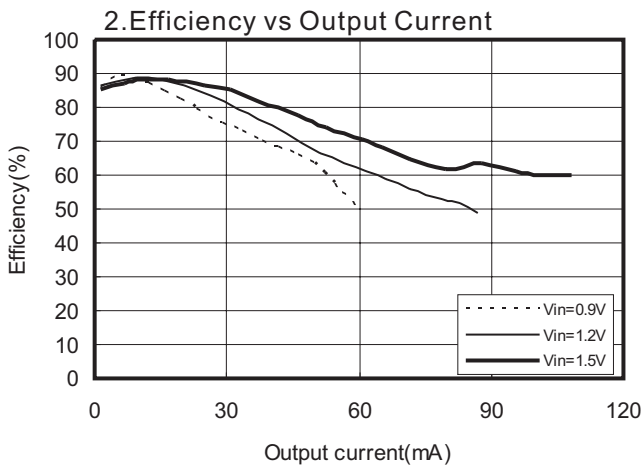
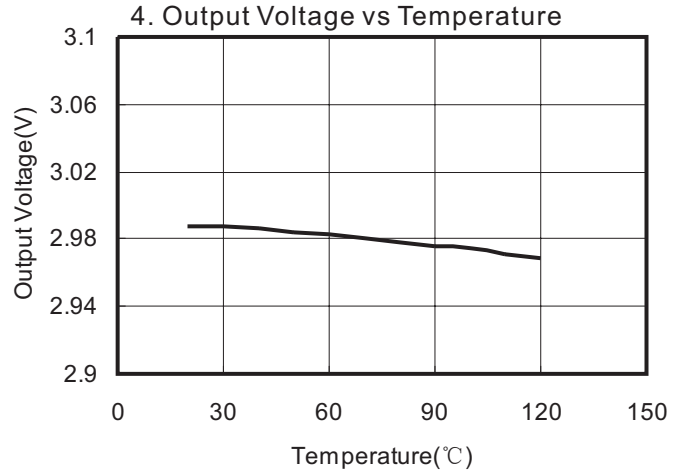
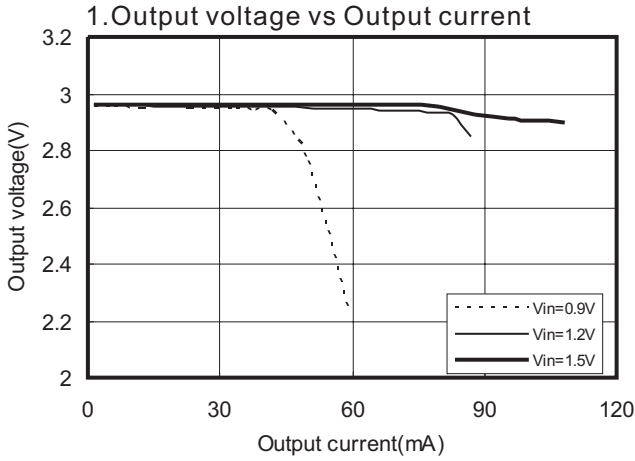

Typical Performance Characteristics (continued)

$C_{IN}=22\mu F, C_O=47\mu F, T_A=25^\circ C$, unless otherwise noted.

$V_O=3.3V$

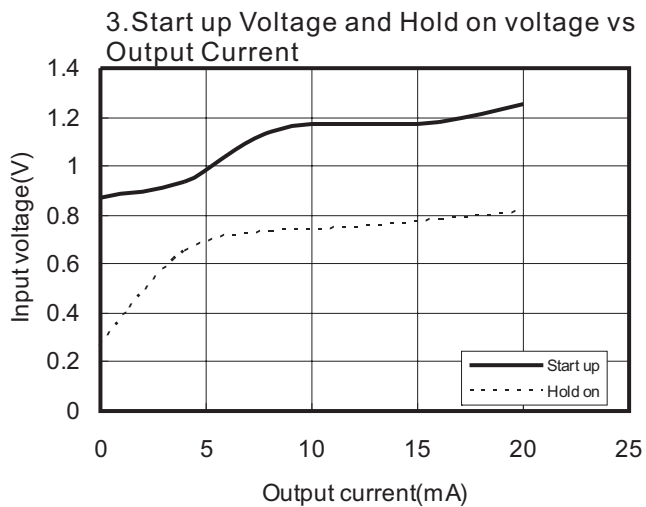
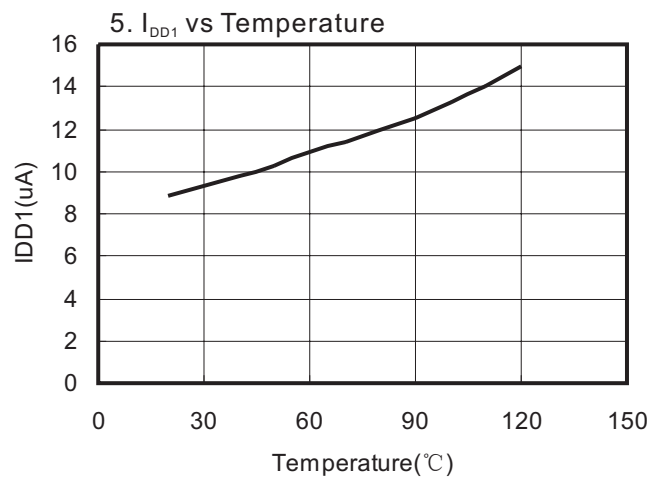
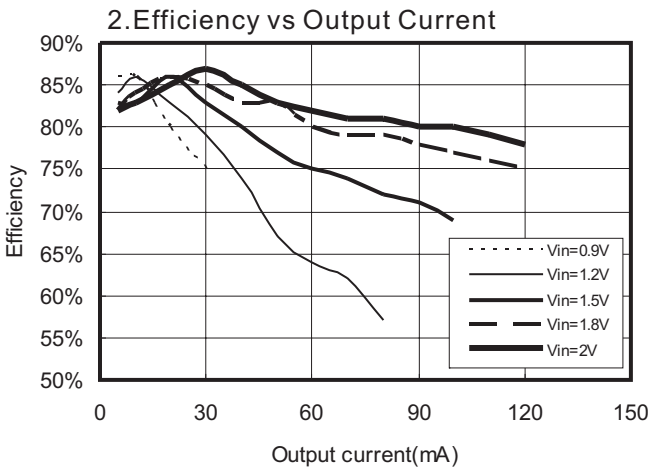
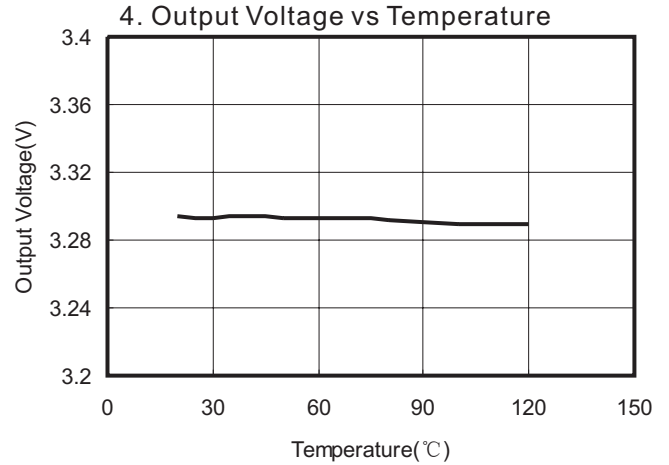
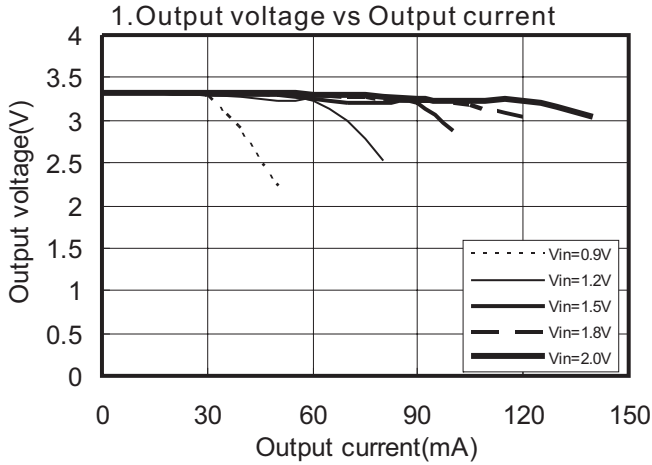

Typical Performance Characteristics (continued)

$C_{IN}=22\mu F, C_O=47\mu F, T_A=25^\circ C$, unless otherwise noted.

$V_o=3.8V$

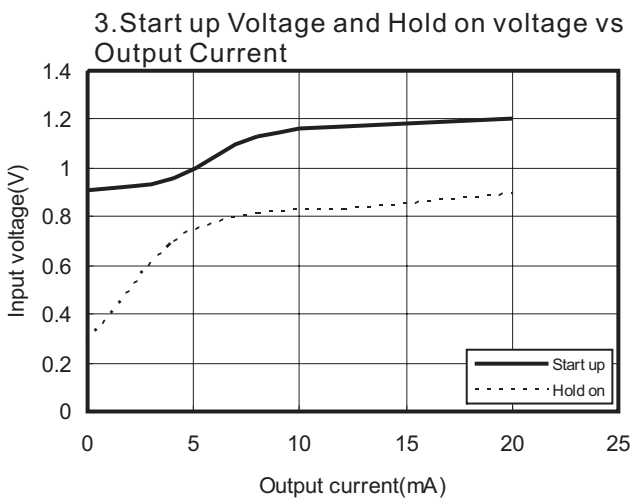
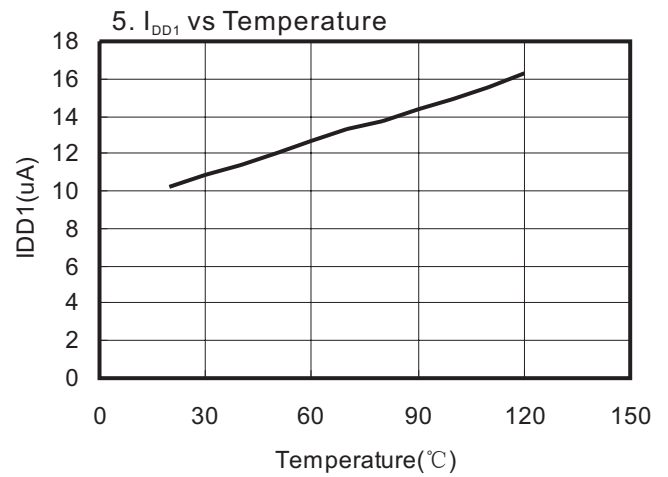
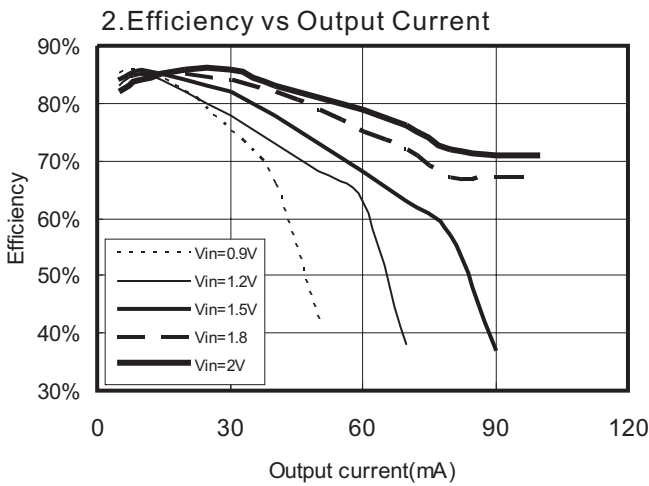
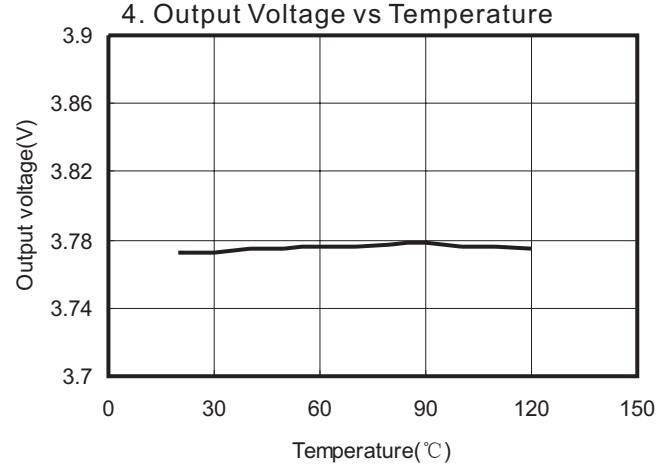
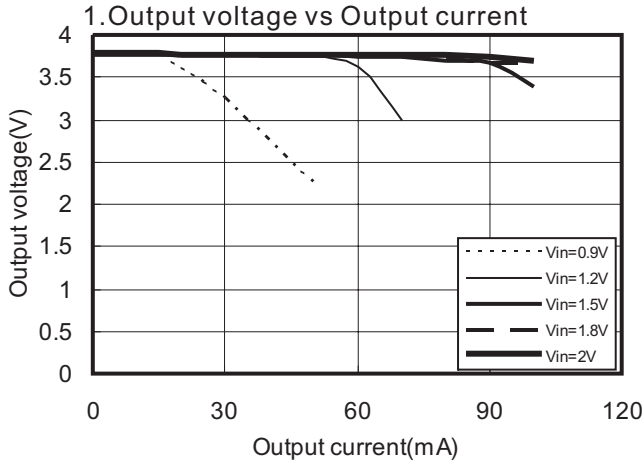

Typical Performance Characteristics (continued)

$C_{IN}=22\mu F, C_O=47\mu F, T_A=25^\circ C$, unless otherwise noted.

$V_O=5.0V$

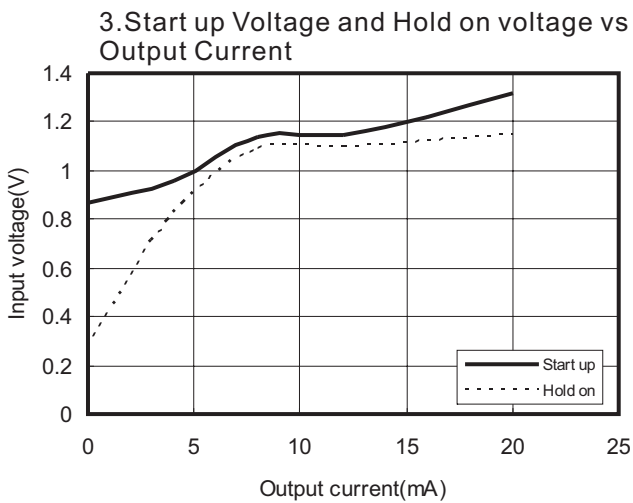
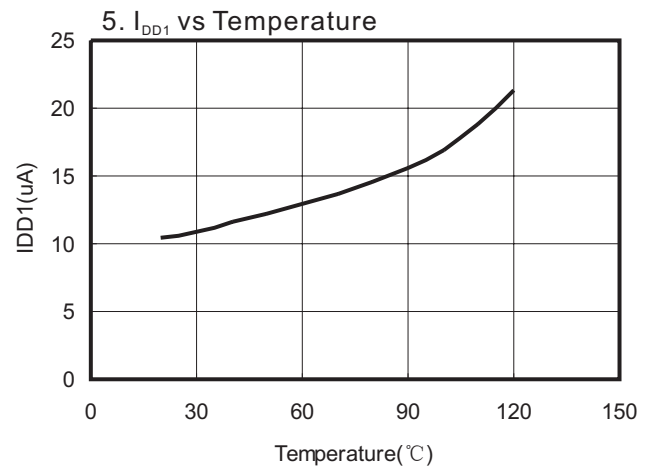
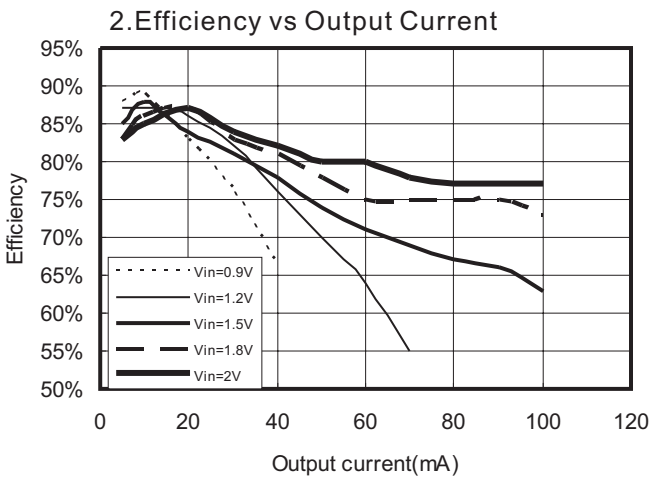
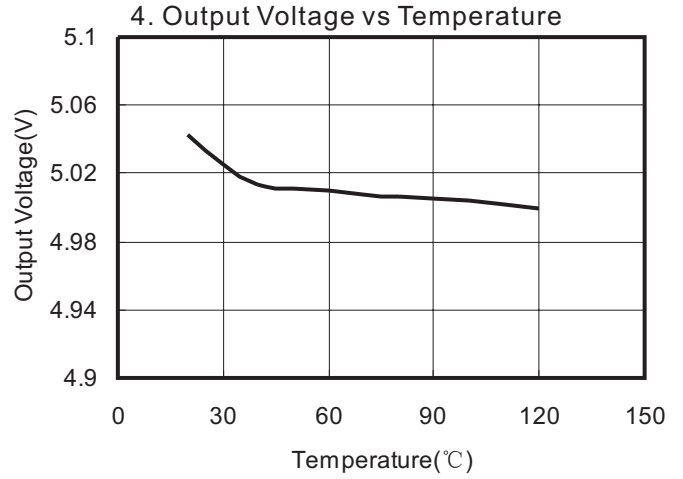
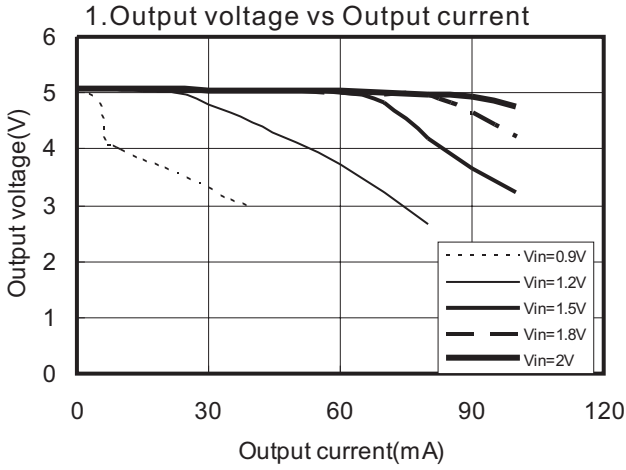

Application Information

Inductor Selection

To select an inductor for PAM2400 applications, it should be noted that the inductors current saturation rating should be larger than the possible peak inductor current to ensure proper operation, and it should have low DCR (DC resistance). Using an inductor with the saturation current lower than the possible peak indicator current can cause a dramatic drop in the inductance and severely decay the maximum output current levels. An inductor is chosen based on desired ripple current. Larger inductors result in lower ripple currents, and smaller ones higher ripple. A 100uH inductor will be a suitable choice for most PAM2400 applications. The following equation can also help to get a good approximate value for the inductor.

$$L = V_{IN} * D / (\Delta I_L * f)$$

$$D \text{ (Duty Cycle)} = 1 - V_{IN} / V_{OUT}$$

ΔI_L (Ripple Current) in the Inductor, i.e., 20% to 40% of the maximum inductor current(I_p).

F (Switching Frequency)=100K.

Output and Input Capacitor Selection

Input Capacitor

An input capacitor of minimum 22µF is recommended to reduce input ripple and switching noise for normal operating conditions. A larger capacitor with lower ESR (Equivalent Series Resistance) may be needed if the application requires very low input ripple. Usually ceramic capacitors are a good choice for applications. Note that the input capacitor should be located as close as possible to the IC.

Output Capacitor

A minimum 47µF output capacitor is recommended and may-be a larger one is better. The total output voltage ripple has two components, the capacitive ripple caused by the charging and discharging on the output capacitor, and the ohmic ripple due to the capacitor's equivalent series resistance (ESR):

$$V_{RIPPLE} = V_{RIPPLE(C)} + V_{RIPPLE(ESR)}$$

$$V_{RIPPLE(C)} \approx 1/2 * (L / (C_{(OUT)} * ((V_{OUT(MAX)} - V_{IN(MIN)})))) * (I_{PEAK}^2 - I_{OUT}^2)$$

$$\text{And } V_{RIPPLE(ESR)} = I_{PEAK} * R_{ESR(COUT)}$$

Where I_{peak} is the peak inductor current.

Multilayer ceramic capacitors are a good choice as they have extremely low ESR and are available in small footprints. Capacitance and ESR variation vs temperature should be considered for best performance in applications with wide operating temperature ranges.

Component Power Dissipation

Operating in discontinuous mode, power loss in the winding resistance of the inductor is approximately equal to

$$PDL = 2/3(T_{ON}/L) * R_D * ((V_{OUT} + V_F) / V_{OUT}) * P_{OUT}$$

The power dissipated in a switch loss is

$$PD_{sw} = 2/3(T_{ON}/L) * R_{ON} * ((V_{OUT} + V_D - V_{IN}) / V_{OUT}) * (P_{OUT})$$

The power dissipated in rectifier diode(Internal Diode) is

$$PD_d = V_D * I_{OUT}$$

Where $P_{OUT} = V_{OUT} * I_{OUT}$, R_D =Inductor DCR, V_D =Diode drop

PC Board Layout considerations

Careful PC board layout is important for minimizing ground bounce and noise. Keep the IC's GND pin and the ground leads of input and output capacitors as close as possible. In addition, connect L1 and SW with short and wide connections.



PAM2400

3-Pin Synchronous Step-Up DC/DC Converter

Ordering Information

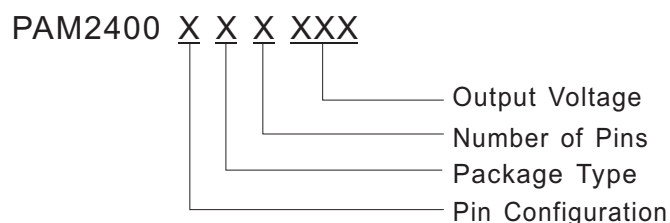

Pin Configuration	Package Type	Number of Pins	Output Voltage
A Type	A: SOT-23-3 C: SOT-89-3	A: 3	200: 2.0V 270: 2.7V 280: 2.8V 300: 3.0V 330: 3.3V 380: 3.8V 500: 5.0V
1. GND			
2. VOUT			
3. SW			

Part Number	Output Voltage	Marking	Package Type	MOQ
PAM2400AAA200	2.0V	CCGYW	SOT-23-3	3,000Unites/Tape&Reel
PAM2400ACA200	2.0V	P2400G XXXYW	SOT-89-3	1,000Unites/Tape&Reel
PAM2400AAA270	2.7V	CCHYW	SOT-23-3	3,000Unites/Tape&Reel
PAM2400ACA270	2.7V	P2400H XXXYW	SOT-89-3	1,000Unites/Tape&Reel
PAM2400AAA280	2.8V	CCRYW	SOT-23-3	3,000Unites/Tape&Reel
PAM2400ACA280	2.8V	P2400R XXXYW	SOT-89-3	1,000Unites/Tape&Reel
PAM2400AAA300	3.0V	CCCYW	SOT-23-3	3,000Unites/Tape&Reel
PAM2400ACA300	3.0V	P2400C XXXYW	SOT-89-3	1,000Unites/Tape&Reel
PAM2400AAA330	3.3V	CCDYW	SOT-23-3	3,000Unites/Tape&Reel
PAM2400ACA330	3.3V	P2400D XXXYW	SOT-89-3	1,000Unites/Tape&Reel
PAM2400AAA380	3.8V	CCEYW	SOT-23-3	3,000Unites/Tape&Reel
PAM2400ACA380	3.8V	P2400E XXXYW	SOT-89-3	1,000Unites/Tape&Reel
PAM2400AAA500	5.0V	CCFYW	SOT-23-3	3,000Unites/Tape&Reel
PAM2400ACA500	5.0V	P2400F XXXYW	SOT-89-3	1,000Unites/Tape&Reel

Outline Dimension

SOT89-3

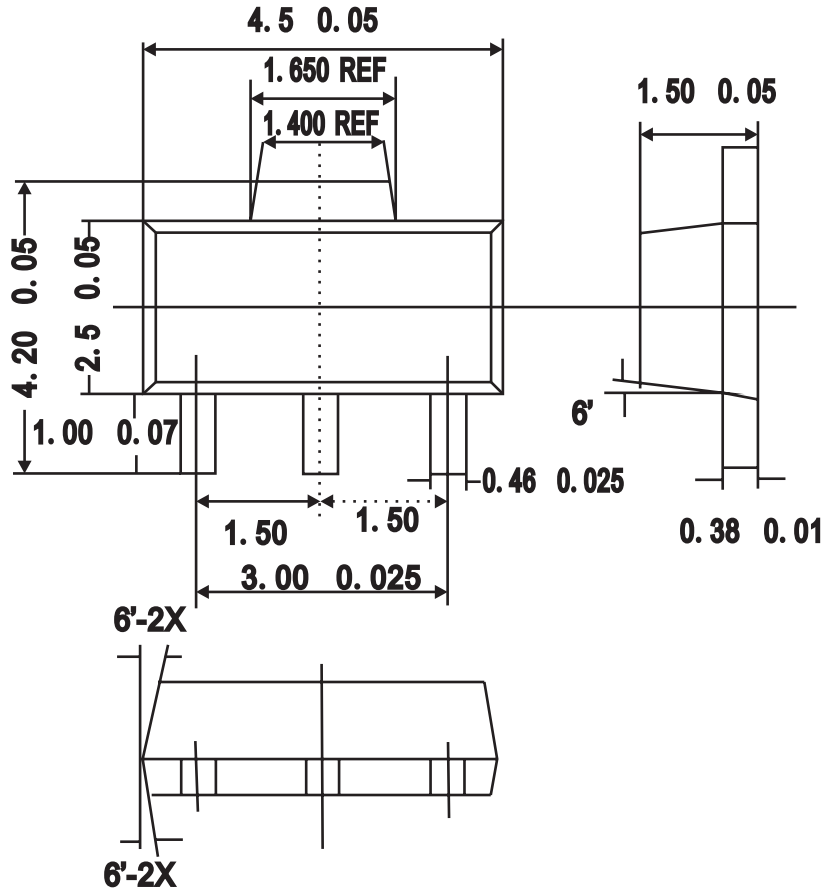

(Unit: mm)

Outline Dimension

SOT23-3

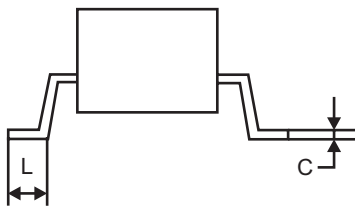
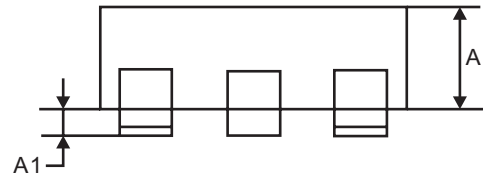
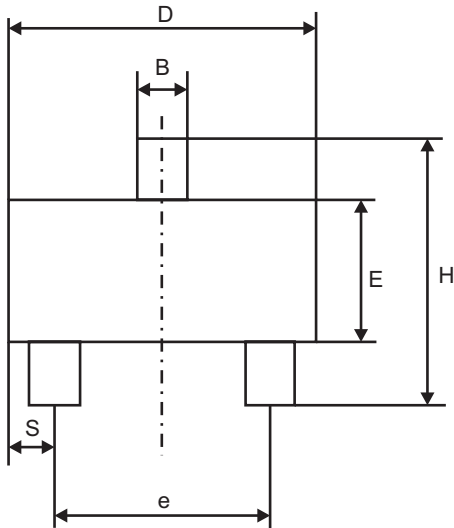

Dim	Millimeters		
	Min.	Typ.	Max.
A	1.00	1.15	1.30
A1	0.00	0.05	0.10
B	0.35	0.43	0.51
C	0.10	0.175	0.25
D	2.70	2.90	3.10
E	1.40	1.60	1.80
e	1.90BSC		
H	2.40	2.70	3.00
L	0.37		