

High-performance video signal Switcher Series

**Video Drivers with Built-in****Low Voltage operation Single Video Switchers**

High-performance System video Driver Series

**Video Drivers with Built-in****Input Selection SW**

BH76330FVM, BH76331FVM, BH76360FV, BH76361FV

High-performance video signal Switcher Series

**Wide Band****Low Voltage operation Single Video Switchers**

BH76332FVM, BH76333FVM, BH76362FV, BH76363FV

No.09065EAT01

## INDEX

**Video Drivers with Built-in****Low Voltage operation Single Video Switchers**

BH76330FVM (3input 1output Video Switch) . . . . . P2

BH76331FVM (3input 1output Video Switch) . . . . . P2

BH76360FV (6input 1output Video Switch) . . . . . P17

BH76361FV (6input 1output Video Switch) . . . . . P17

**Wide Band****Low Voltage operation Single Video Switchers**

BH76332FVM (3input 1output Video Switch) . . . . . P2

BH76333FVM (3input 1output Video Switch) . . . . . P2

BH76362FV (6input 1output Video Switch) . . . . . P17

BH76363FV (6input 1output Video Switch) . . . . . P17

## Line-up of products with built-in video amplifier and video driver

# 3-input, 1-output video switch

## BH76330FVM, BH76331FVM, BH76332FVM, BH76333FVM

### ● General

BH76330FVM, BH76331FVM, BH76332FVM, and BH76333FVM are video signal switching ICs, each with three inputs and one circuit input, which feature wide dynamic range and frequency response. Since these ICs can be used with low voltage starting at VCC = 2.8 V, they are applicable not only in stationary devices but also in mobile devices.

This product line-up supports a broad range of input signals, depending on whether or not a 6-dB video amplifier and video driver are included and what combination of sync tip clamp type and bias (resistor termination) type inputs are used.

### ● Features

- 1) Able to use a wide range of power supply voltage, from 2.8 V to 5.5 V
- 2) Wide output dynamic range
- 3) Excellent frequency response  
(BH76330FVM and BH76331FVM: 100 kHz/10 MHz 0 dB [Typ.], BH76332FVM and BH76333FVM: 100 kHz/30 MHz 0 dB [Typ.])
- 4) No crosstalk between channels (Typ. -65 dB, f = 4.43 MHz)
- 5) Built-in standby function, circuit current during standby is 0 μA (Typ.)
- 6) Sync tip clamp input (BH76330FVM, BH76332FVM)
- 7) Bias input (Zin = 150 kΩ) (BH76331FVM, BH76333FVM)
- 8) 6-dB amp and 75Ω driver are built in (BH76330FVM, BH76331FVM)
- 9) Enables two load drivers [when using output coupling capacitor] (BH76330FVM, BH76331FVM)
- 10) Able to be used without output coupling capacitor (BH76330FVM)
- 11) MSOP8 compact package

### ● Applications

Input switching in car navigation systems, TVs, DVD systems, etc.

### ● Line-up

	BH76330FVM	BH76331FVM	BH76332FVM	BH76333FVM
Supply voltage	2.8 V to 5.5 V			
Amp gain	6 dB		-0.1 dB	
Video driver	Included		-	
Frequency response	100 kHz/10 MHz, 0 dB (Typ.)		100 kHz/30 MHz, 0 dB (Typ.)	
Input type	Sync tip clamp	Bias (Zin = 150 kΩ)	Sync tip clamp	Bias (Zin = 150 kΩ)

### ● Absolute maximum ratings (Ta = 25°C)

Parameter	Symbol	Limits	Unit
Supply voltage	VCC	7.0	V
Power dissipation	Pd	470 *1	mW
Input voltage range	VIN	0 to VCC+0.2	V
Operating temperature range	Topr	-40 to +85	°C
Storage temperature range	Tstg	-55 to +125	°C

\*1 When used while Ta = 25°C, 4.7 mW is dissipated per 1°C  
Mounted on 70 mm x 70 mm x 1.6 mm glass epoxy board

### ● Operation range (Ta = 25°C)

Parameter	Symbol	Min.	Typ.	Max	Unit
Supply voltage	VCC	2.8	5.0	5.5	V

● Electrical characteristics 1 (unless otherwise specified, Ta = 25°C, VCC = 5 V)

Parameter	Symbol	Typ.				Unit	Conditions
		76330	76331	76332	76333		
Circuit current 1	ICC1	10		9		mA	When no signal
Circuit current 2	ICC2	0.0				μA	During standby
Circuit current 3	ICC3-1	11		10		mA	During output of color bar signal
	ICC3-2	17	—				During output of color bar signal (no C in output)
Maximum output level	VOM	4.6		3.8	3.4	Vpp	f = 10 kHz, THD = 1%
Voltage gain	Gv	6.0		-0.1		dB	Vin = 1.0 Vpp, f = 100 kHz
Frequency response	GF1	0		—		dB	Vin = 1.0 Vpp, f = 10 MHz/100 kHz
	GF2	—		0		dB	Vin = 1.0 Vpp, f = 30 MHz/100 kHz
Crosstalk between channels	CT	-65				dB	Vin = 1.0 Vpp, f = 4.43 MHz
Mute attenuation	MT	-65				dB	Vin = 1.0 Vpp, f = 4.43 MHz
CTL pin switch level	VTHH	1.2 Min				V	High level threshold voltage
	VTHL	0.45 Max				V	Low level threshold voltage
CTL pin inflow current	ITHH	50 Max				μA	CTL pin = 2.0 V applied
Input impedance	Zin	—	150	—	150	kΩ	
Differential gain	DG	0.3				%	Vin = 1.0 Vpp
Differential phase	Dp-1	0.7		0.3		deg.	Standard stair step signal
	Dp-2	0.0	—				Same condition as above (no C in output)
Y-related S/N	SNY	+75		+78		dB	Vin = 1.0 Vpp, bandwidth: 100 k to 6 MHz 100% white video signal
C-related S/N [AM]	SNCA	+75				dB	Vin = 1.0 Vpp, bandwidth: 100 to 500 kHz
C-related S/N [PM]	SNCP	+65					100% chroma voltage signal

● Electrical characteristics 2 (unless otherwise specified, Ta = 25°C, VCC = 3 V)

Parameter	Symbol	Typ.				Unit	Conditions
		76330	76331	76332	76333		
Circuit current 1	ICC1	8.5		8.0		mA	When no signal
Circuit current 2	ICC2	0.0				μA	During standby
Circuit current 3	ICC3-1	9.5		9.0		mA	During output of color bar signal
	ICC3-2	15.5	—				During output of color bar signal (no C in output)
Maximum output level	VOM	2.7	2.8	1.8	1.9	Vpp	f = 10 kHz, THD = 1%
Voltage gain	Gv	6.0		-0.1		dB	Vin = 1.0 Vpp, f = 100 kHz
Frequency response	GF1	0		—		dB	Vin = 1.0 Vpp, f = 10 MHz/100 kHz
	GF2	—		0		dB	Vin = 1.0 Vpp, f = 30 MHz/100 kHz
Crosstalk between channels	CT	-65				dB	Vin = 1.0 Vpp, f = 4.43 MHz
Mute attenuation	MT	-65				dB	Vin = 1.0 Vpp, f = 4.43 MHz
CTL pin switch level	VTHH	1.2 Min				V	High level threshold voltage
	VTHL	0.45 Max				V	Low level threshold voltage
CTL pin inflow current	ITHH	50 Max				μA	CTL pin = 2.0 V applied
Input impedance	Zin	—	150	—	150	kΩ	
Differential gain	DG	0.3	0.7	0.3		%	Vin = 1.0 Vpp
Differential phase	Dp-1	1.0		0.3		deg.	Standard stair step signal
	Dp-2	0.5	—				Same condition as above (no C in output)
Y-related S/N	SNY	+75		+78		dB	Vin = 1.0 Vpp, bandwidth: 100 k to 6 MHz 100% white video signal
C-related S/N [AM]	SNCA	+75				dB	Vin = 1.0 Vpp, bandwidth: 100 to 500 kHz
C-related S/N [PM]	SNCP	+65					100% chroma video signal

(Note) Re: ICC3, VOM, Gv, GF, CT, MT, DG, Dp, SNY, SNCA, and SNCP parameters

BH76330FVM and BH76331FVM: RL = 150 Ω

BH76332FVM and BH76333FVM: RL = 10 kΩ

● Control pin settings

	CTL	
	A	B
STBY	L(OPEN)	L(OPEN)
IN1	L(OPEN)	H
IN2	H	L(OPEN)
IN3	H	H

● Block diagram

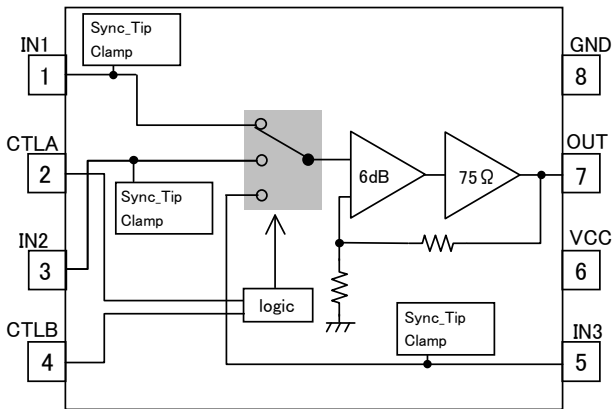

Fig.1 BH76330FV

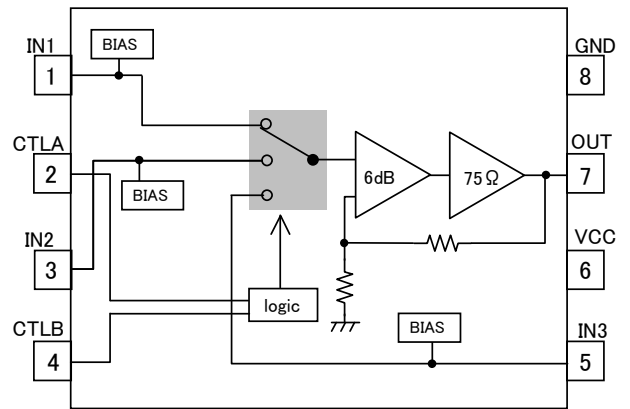

Fig.2 BH76331FV

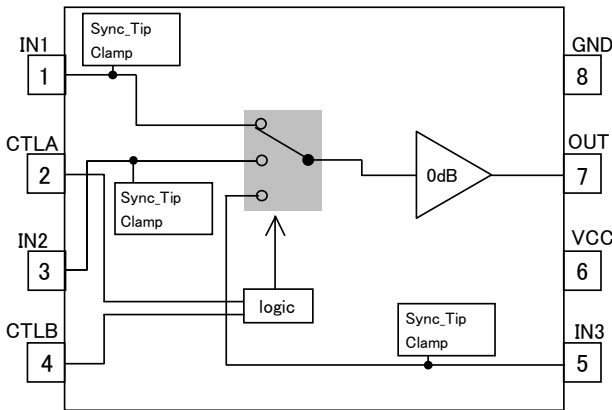

Fig.3 BH76332FV

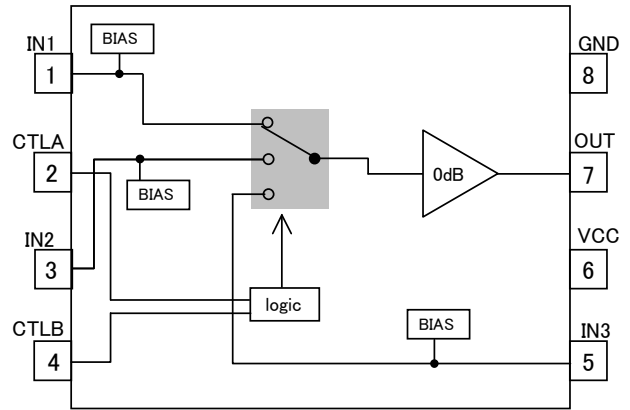

Fig.4 BH76333FV

● I/O equivalent circuit diagrams

Input pins

Sync tip clamp input BH76330FVM/BH76332FVM			Bias input BH76331FVM/BH76333FVM		
Pin No.	Name	Equivalent circuit	Pin No.	Name	Equivalent circuit
1 3 5	IN1 IN2 IN3		1 3 5	IN1 IN2 IN3	
Video signal input pin is used for sync tip clamp input. • DC potential BH76330FVM: 1.5 V      BH76332FVM: 1.0 V			Video signal input pin is used for bias type input. Input impedance is 150 kΩ. • DC potential BH76331FVM: 3.1 V      BH76333FVM: 2.5 V		

Control pins

Pin No.	Name	Equivalent circuit
2 4	CTLA CTLB	
Switches operation mode [active or standby] and input pin. Threshold level is 0.45 V to 1.2 V.		

Output pin

With video driver BH76330FVM/BH76331FVM			Without video driver BH76332FVM/BH76333FVM		
Pin No.	Name	Equivalent circuit	Pin No.	Name	Equivalent circuit
7	OUT		7	OUT	
Video signal output pin. Able to drive loads up to 75 Ω (dual drive). • DC potential BH76330FVM: 0.16 V      BH76331FVM: 2.5 V			Video signal output pin. • DC potential BH76332FVM: 0.3 V      BH76333FVM: 1.8 V		

Note 1) The above DC potential is only when VCC = 5 V. This value is a reference value and is not guaranteed.

Note 2) Numerical values shown in these figures are design values, and compliance to standards is not guaranteed.

● Test Circuit Diagrams

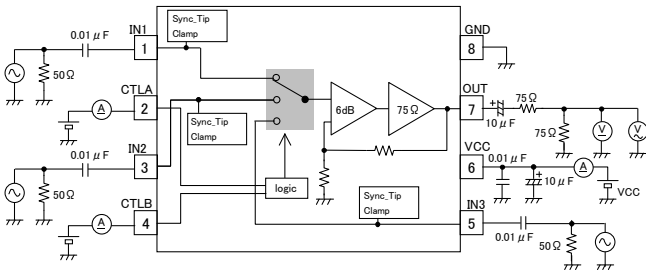

Fig. 5 BH76330FV/BH76331FV Test Circuit Diagram

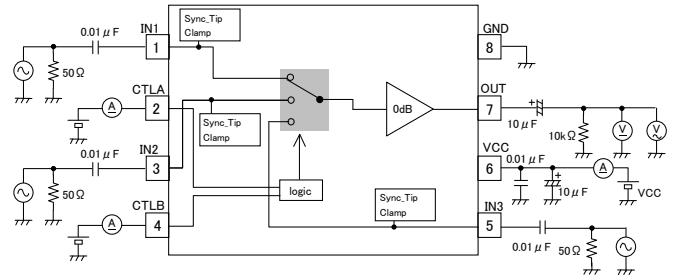

Fig. 6 BH76332FV/BH76333FV Test Circuit Diagram

Test circuit diagrams are used for shipment inspections, and differ from application circuits.

● Application circuit examples

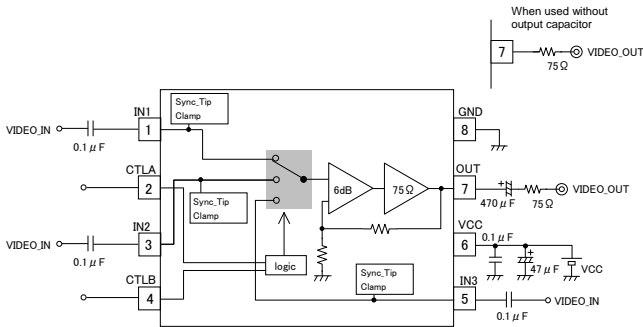

Fig. 7 BH76330FV

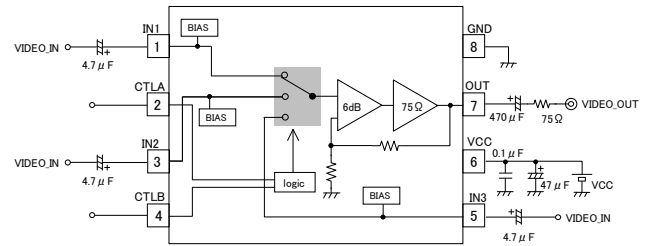

Fig. 8 BH76331FV

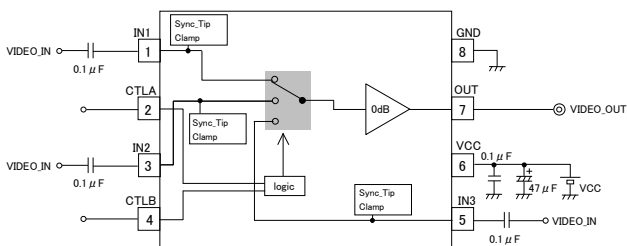

Fig. 9 BH76332FV

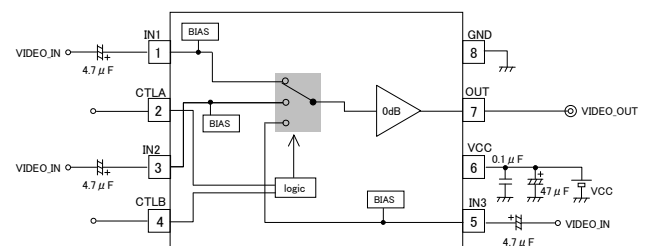

Fig. 10 BH76333FV

See pages 6/16 to 10/16 for description of how to determine the capacity of I/O coupling capacitors.

● Cautions for selection and use of application parts

When using this IC by itself ①

Input type	Input impedance Z <sub>in</sub>	Capacity of input coupling capacitor (recommended value)	Capacity of output coupling capacitor (recommended value)
Sync_Tip_Clamp	10 MΩ	0.1 μF	470 μF to 1000 μF
Bias	150 kΩ	4.7 μF	

Method for determining capacity of input coupling capacitor

The HPF is comprised of an input coupling capacitor and the internal input impedance Z<sub>in</sub> of the IC. Since the fc value of this HPF is determined using the following equation (a), the above recommended capacity for the input capacitor is derived. Usually, the cutoff frequency fc is several Hz.

$$f_c = 1 / (2\pi \times C \times Z_{in}) \dots (a)$$

When evaluating the sag characteristics and determining the capacity of the capacitor during video signal input, a horizontal stripe signal called "H bar" (shown in Fig. 10) is suitable, and this type of signal is used instead of a color bar signal to evaluate characteristics and determine capacity.



Fig.11 Example of Screen with Obvious Sag (H-bar Signal)

Method for determining capacity of output coupling capacitor

The output pins of models with a 75Ω driver [BH76330FVM and BH76331FVM] have an HPF comprised of an output coupling capacitor and load resistance R<sub>L</sub> (= 150Ω). When fc is set to approximately 1 Hz or 2 Hz, the capacity of the output coupling capacitor needs to be approximately 470 μF to 1000 μF.

As for models without the 75Ω driver, an HPF is similarly comprised using the capacity of the output coupling capacitor and the input impedance of the IC connected at the next stage, and the capacitance required for the output coupling capacitor should be estimated using equation (a).

When this IC is used as a standalone device ②

In models that include a 75Ω driver [BH76330FVM and BH76331FVM], up to two monitors (loads) can be connected (a connection example is shown in Fig. 12). When there are multiple loads, the number of output coupling capacitors must be increased or a larger capacitance must be used, based on the table shown below.

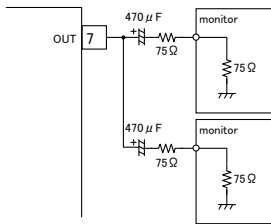

Fig. 12 (a) Application Circuit Example 1 (Two Drives)

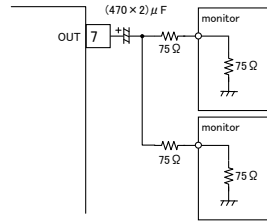

Fig. 12 (b) Application Circuit Example 2 (Two Drives)

Application circuit example	No. of output capacitors	Capacitance per output capacitor (recommended values)
Fig. 12 (a)	No. of drives required	470 μF to 1000 μF (same as with one drive)
Fig. 12 (b)	1	(No. of drive × 470 μF to 1000) uF

When this IC is used as a standalone device ③

The BH76330FVM is the only model that can be used without an output coupling capacitor.

This use method not only enables reductions in board space and part-related costs, but it is able to improve the sag characteristics by improving low-range frequency response. However, when the output coupling capacitor is omitted, a direct current flows to the connected set, so the specifications of the connected set should be noted carefully before starting use.

Note also that only one load can be connected when the output coupling capacitor is omitted.

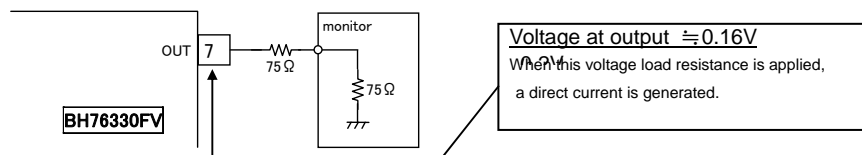

Fig.13 Application Example without Output Coupling Capacitor

When using several of these ICs ①

When several of these ICs are used, it enables applications in which separate images are output to the car navigation system's front and rear monitors.

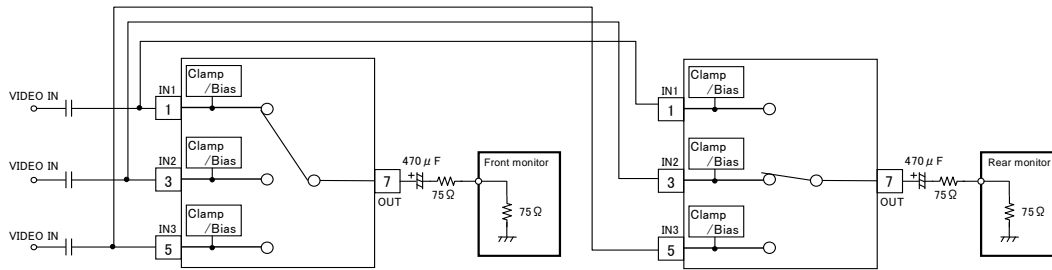

Fig.14 Application Example when Using Several ICs

When several ICs are used at the same time, the number of parallel connections of input impedance equals the number of ICs being used, which reduces the input impedance. This also raises the  $f_c$  value of the HPF formed at the input pin block, so the capacitance of the input coupling capacitor must be increased according to equation (a). The recommended values for calculation results are listed in the table below.

When a clamp is used as the input type, the original input impedance becomes much greater, and if two or three are used at the same time there is no need to change the capacitance of the input coupling capacitor.

Input type	Input impedance per IC	Number of ICs used	Total input impedance	Capacitance of input coupling capacitor (recommended values)
Sync_Tip_Clamp	Approx. 10 MΩ	2	Approx. 5 MΩ	0.1 μF
		3	Approx. 3 MΩ	0.1 μF
Bias	150 kΩ	2	75 kΩ	6.8 μF~
		3	50 kΩ	10 μF~

When using several of these ICs ②

When three bias input type models (BH76331FVM or BH76333FVM) are used in parallel, they can be used for RGB signal switching applications. Likewise, when one clamp input type model (BH76330FVM or BH76332FVM) is connected in parallel with two bias input type models (a total of three ICs used in parallel), they can be used for component signal switching applications. The same method can be used to determine the capacitance of I/O coupling capacitors of these applications.

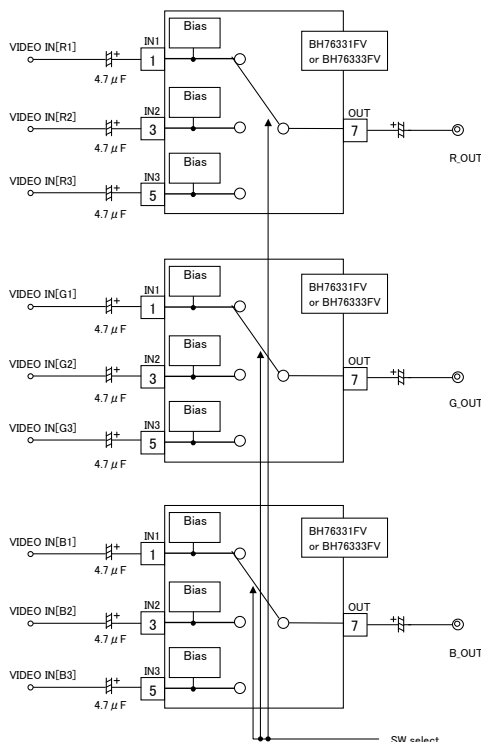

Fig. 15 (a). RGB Signal Switching Application Example (using three bias input type models in parallel)

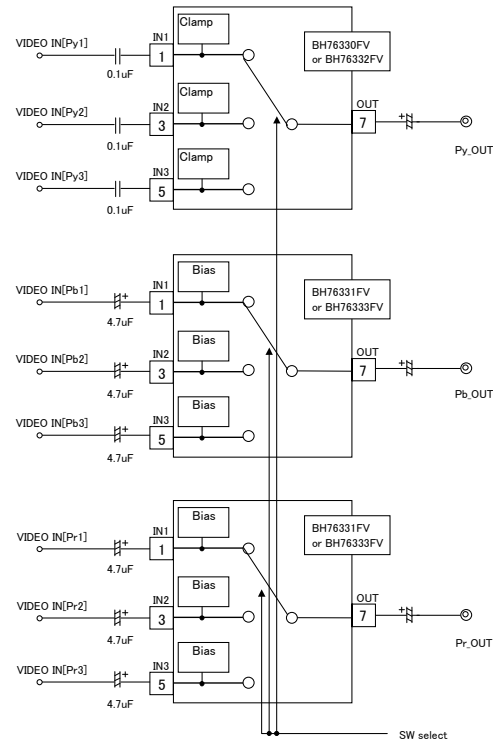

Fig. 15 (b). Component Signal Switching Application Example (using one clamp input type model and two bias input type models in parallel)



● Cautions for use

1. The numerical values and data shown here are typical design values, not guaranteed values.
2. The application circuit examples show recommended circuits, but characteristics should be checked carefully before using these circuits. If any external part constants are modified before use, factors such as variation in all external parts and ROHM LSI ICs, including not only static characteristics but also transient characteristics, should be fully considered to set an ample margin.
3. Absolute maximum ratings  
If the absolute maximum ratings for applied voltage and/or operation temperature are exceeded, LSI damage may result. Therefore, do not apply voltage or use in a temperature that exceeds these absolute maximum ratings. If it is possible that absolute maximum ratings will be exceeded, use a physical safety device such as a fuse and make sure that no conditions that might exceed the absolute maximum ratings will be applied to the LSI IC.
4. GND potential  
Regardless of the operation mode, the voltage of the GND pin should be at least the minimum voltage. Actually check whether or not the voltage at each pin, including transient phenomena, is less than the GND pin voltage.
5. Thermal design  
The thermal design should be done using an ample margin that takes into consideration the allowable dissipation under actual use conditions.
6. Shorts between pins and mounting errors  
When mounting LSI ICs onto the circuit board, make sure each LSI's orientation and position is correct. The ICs may become damaged if they are not mounted correctly when the power is turned on. Similarly, damage may also result if a short occurs, such as when a foreign object is positioned between pins in an IC, or between a pin and a power supply or GND connection.
7. Operation in strong electromagnetic field  
When used within a strong electromagnetic field, evaluate carefully to avoid the risk of operation faults.
8. Place the power supply's decoupling capacitor as close as possible to the VCC pin (PIN 6) and GND pin (PIN 8).
9. With a clamp input type model (BH76330FVM or BH76332FVM), if any unused input pins are left open they will oscillate, so unused input pins should instead be connected to GND via a capacitor or else directly connected to VCC.
10. With models that do not include a 75Ω driver (BH76332FVM or BH76333FVM), in some cases the capacitance added to the set board may cause the peak frequency response to occur at a high frequency. To lower the peak frequency, connect in series resistors having resistance of several dozen Ω to several hundred Ω as close as possible to the output pin.

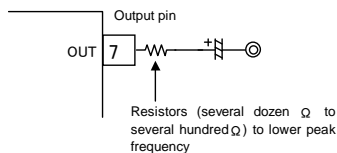

Fig.16 Positions where Resistors are Inserted to Lower Peak Frequency Response in BH76332FV or BH76333FV

11. Frequency response in models that do not include a 75-Ω driver (BH76332FVM and BH76333FVM) was measured as 100 kHz/30 MHz: 0 dB (Typ.) in the application circuit examples (shown in Fig. 9 and Fig. 10), and when resistance of about 1 or 2 kΩ is applied from the IC's output pin to GND, this frequency response can be improved (the lower limit of the applied resistance should be 1 kΩ). In such cases, gain is reduced, since the output voltage is divided by the added resistance and the output resistance of the IC.

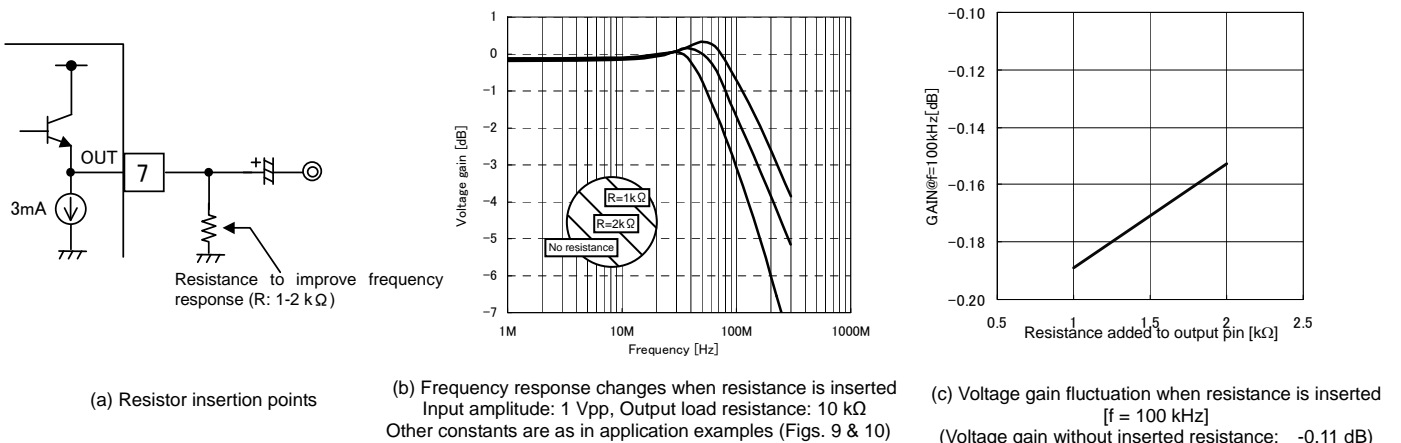

Fig.17 Result of Resistance Inserted to Improve BH76332FVM/BH76333FVM Frequency Response

12. With clamp input type models (BH76330FVM and BH76332FVM), if the termination impedance of the video input pin becomes higher, sync contractions or oscillation-related problems may occur. Evaluate temperature and other characteristics carefully and use at 1 kΩ or less.

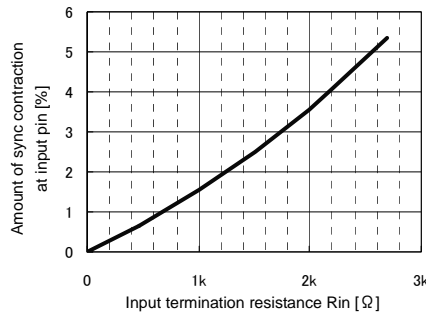

Fig. 18. Relation between Input Pin Termination Impedance and Amount of Sync Contraction

● Evaluation board pattern diagram and circuit diagram

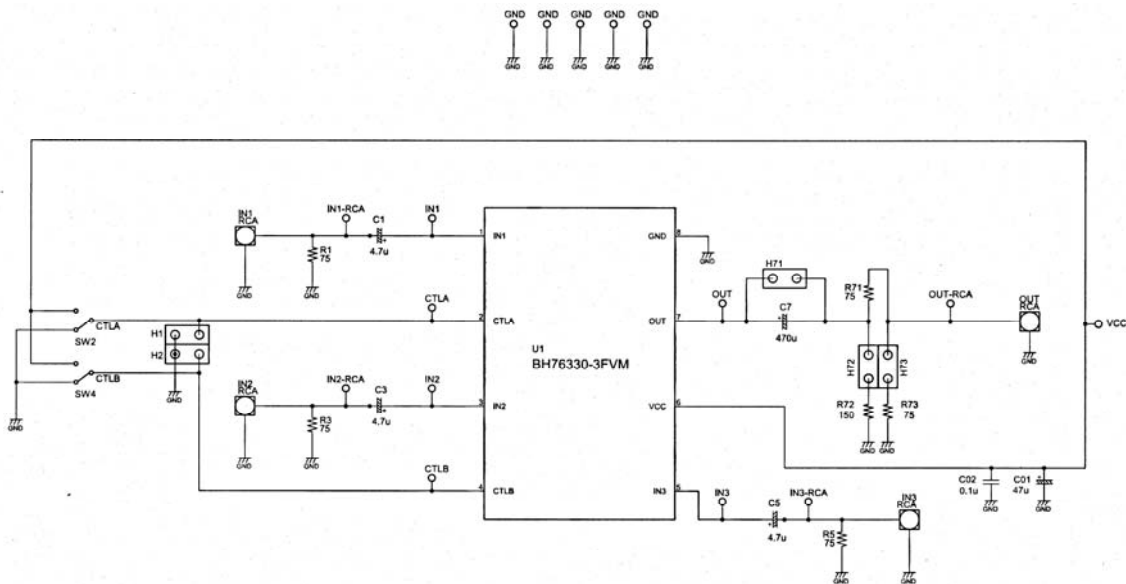

Fig. 19. Evaluation Board Circuit Diagram

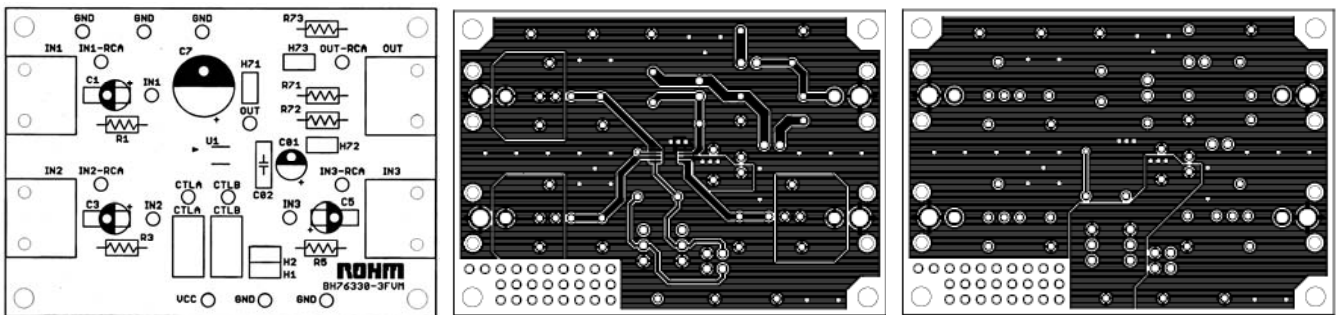
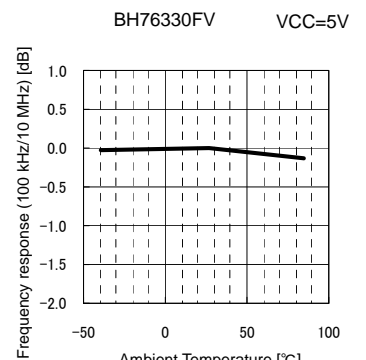
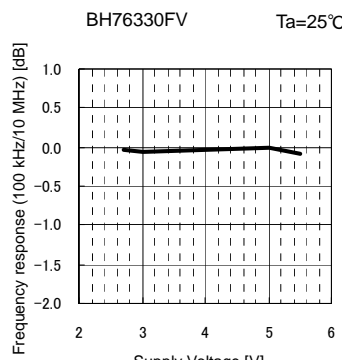
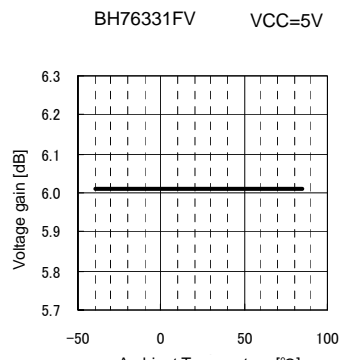
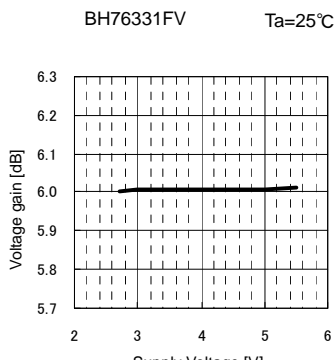
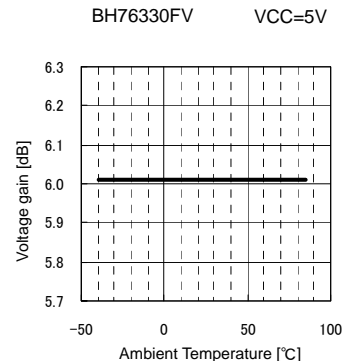
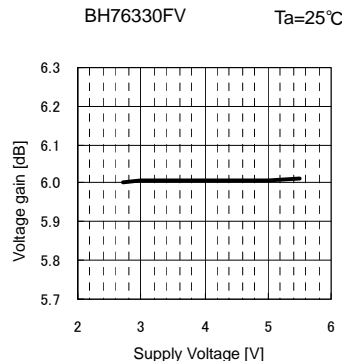
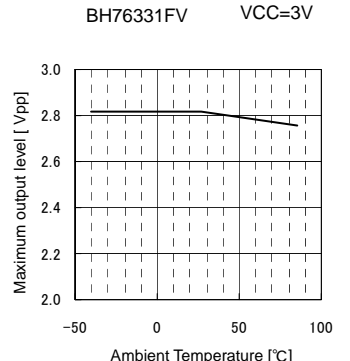
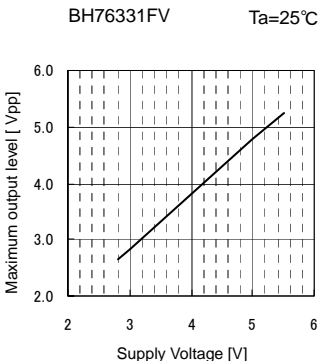
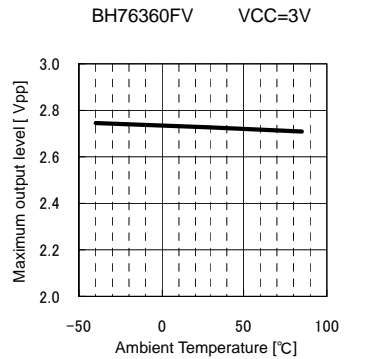
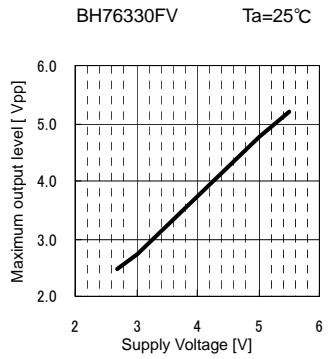
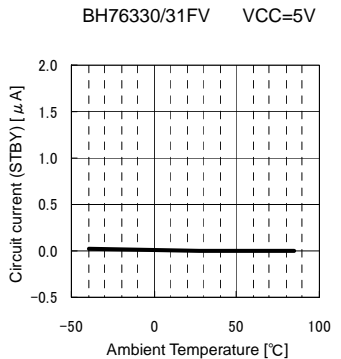
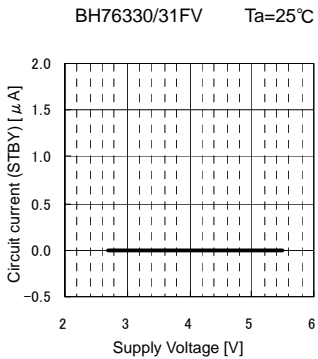
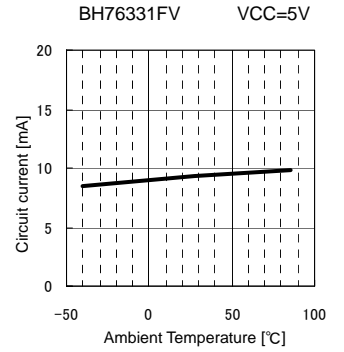
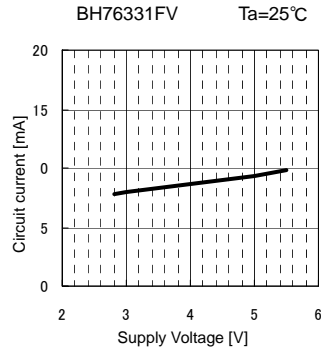
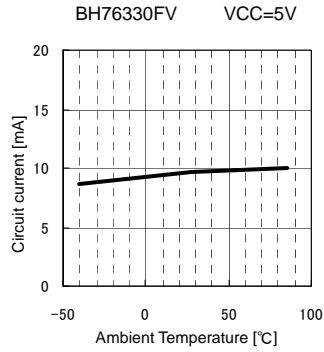
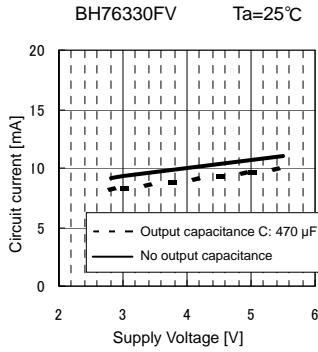

Fig. 20. Evaluation Board Pattern Diagram

Parts list

Symbol	Function	Recommended value	Comments
R1 R3 R5	Input terminating resistor	75 Ω	—
C1 C3 C5	Input coupling capacitor	See pages 6/16 to 7/16 to determine	B characteristics recommended
R71	Output resistor	75 Ω	—
C7	Output coupling capacitor	See pages 6/16 to 7/16 to determine	B characteristics recommended
C01	Decoupling capacitor	10 μF	B characteristics recommended
C02		0.1 μF	

● Reference data (1) BH76330FVM/BH76331FVM [unless otherwise specified, output capacitance C: 470  $\mu$ F,  $R_L = 150 \Omega$ ]



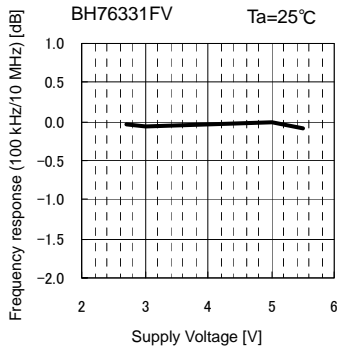

Fig.37  $G_F$  vs. Supply Voltage

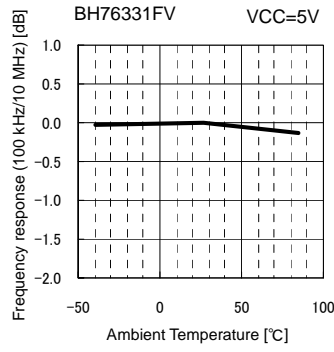

Fig.38  $G_F$  vs. Ambient Temperature

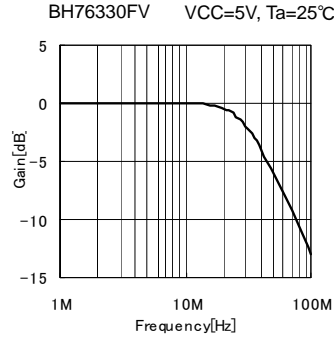

Fig.39 Frequency Response

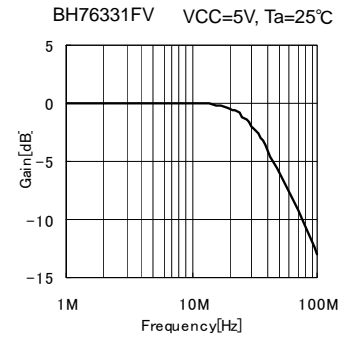

Fig.40 Frequency Response

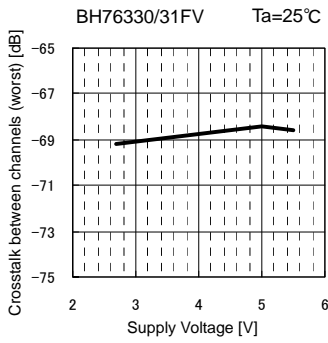

Fig.41 CT(worst) vs. Supply Voltage

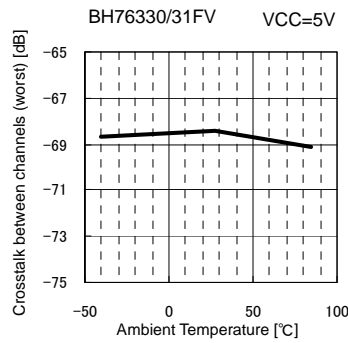

Fig.42 CT(worst) vs. Ambient Temperature

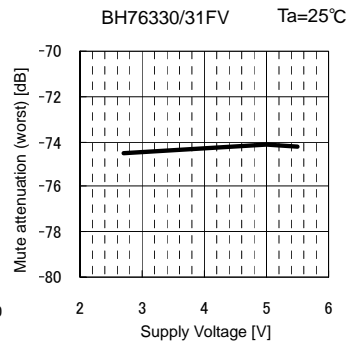

Fig.43 MT(worst) vs. Supply Voltage

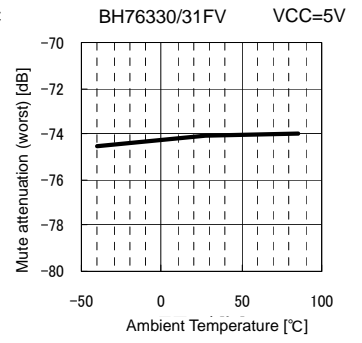

Fig.44 MT(worst) vs. Ambient Temperature

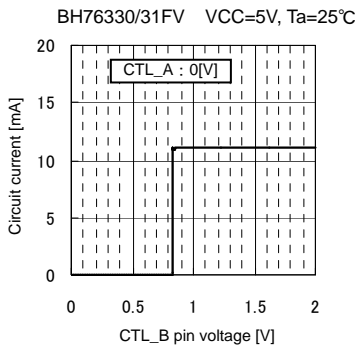

Fig.45 CTLb pin voltage vs Circuit Current (CLT threshold)

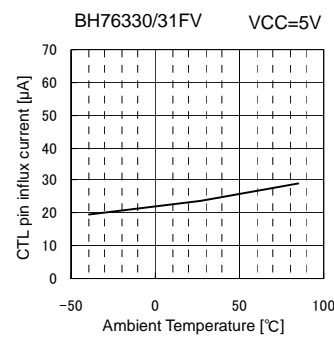

Fig.46  $I_{THH}$  vs. Ambient Temperature (Voltage applied to CTL pin = 2V)

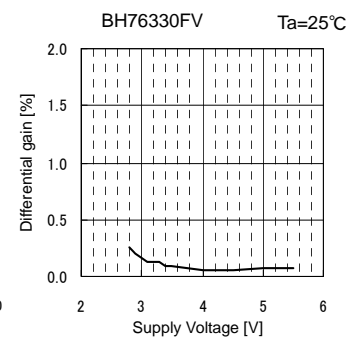

Fig.47 DG vs. Supply Voltage

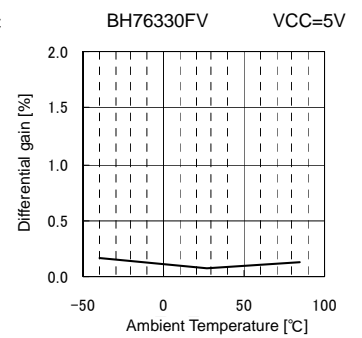

Fig.48 DG vs. Ambient Temperature

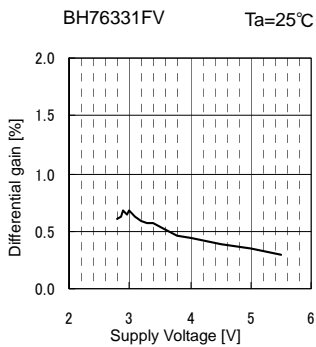

Fig.49 DG vs. Supply Voltage

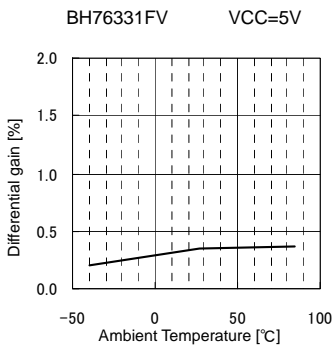

Fig.50 DG vs. Ambient Temperature

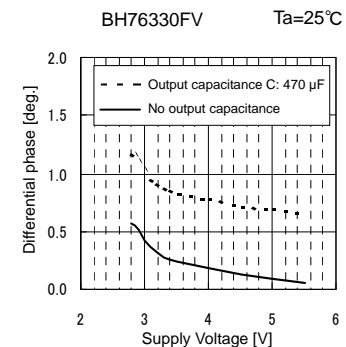

Fig.51 DP vs. Supply Voltage

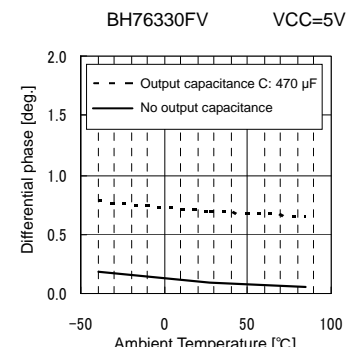

Fig.52 DP vs. Ambient Temperature

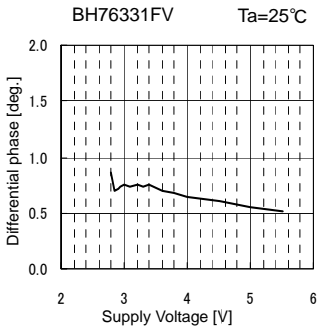

Fig.53 DP vs. Supply Voltage

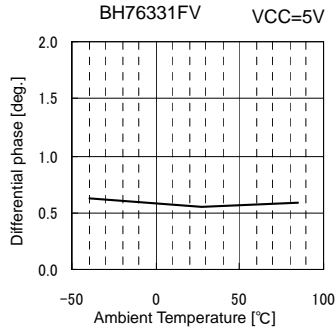

Fig.54 DP vs. Ambient Temperature

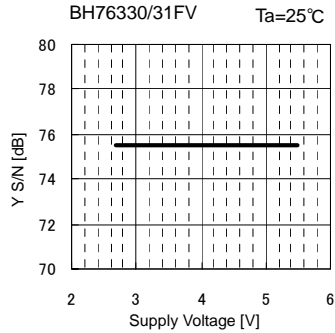

Fig.55 SN<sub>γ</sub> vs. Supply Voltage

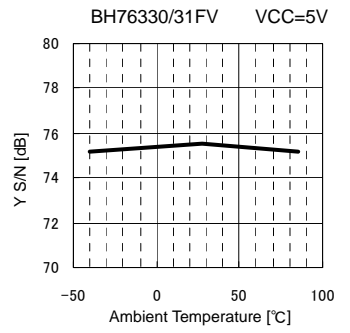

Fig.56 SN<sub>γ</sub> vs. Ambient Temperature

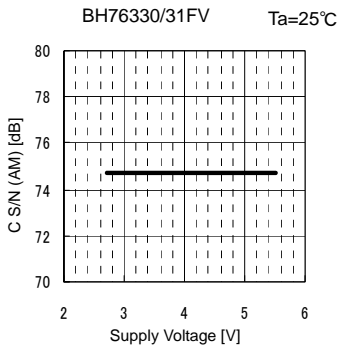

Fig.57 SN<sub>CA</sub> vs. Supply Voltage

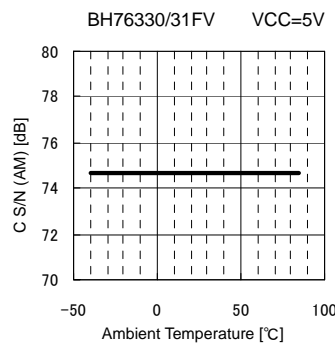

Fig.58 SN<sub>CA</sub> vs. Ambient Temperature

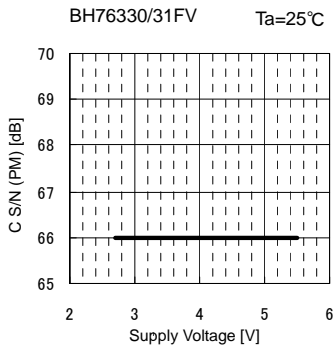

Fig.59 SN<sub>CP</sub> vs. Supply Voltage

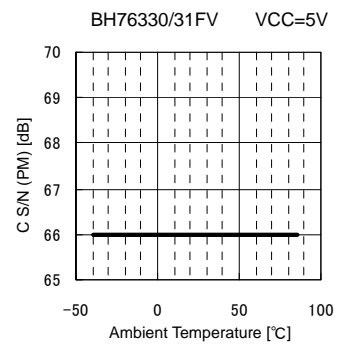

Fig.60 SN<sub>CP</sub> vs. Ambient Temperature

● Reference data (2) BH76332FVM/BH76333FVM [unless otherwise specified, output capacitance C: 470 μF, RL = 10 kΩ]

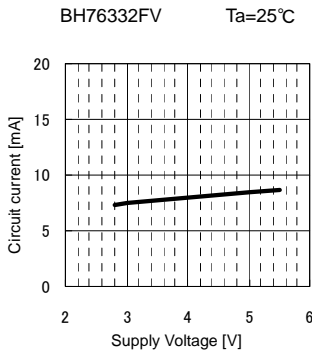

Fig.61 ICC1 vs. Supply Voltage

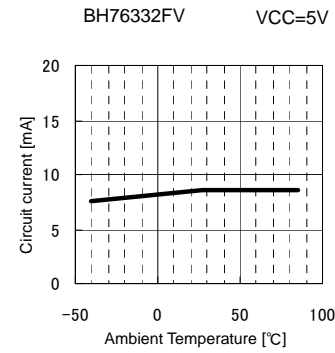

Fig.62 ICC1 vs. Ambient Temperature

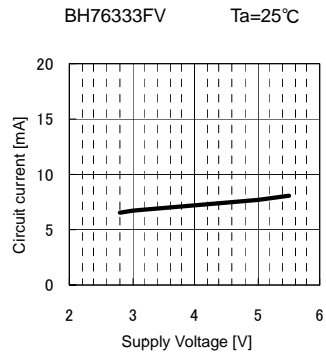

Fig.63 ICC1 vs. Supply Voltage

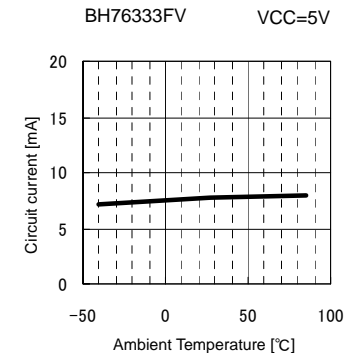

Fig.64 ICC1 vs. Ambient Temperature

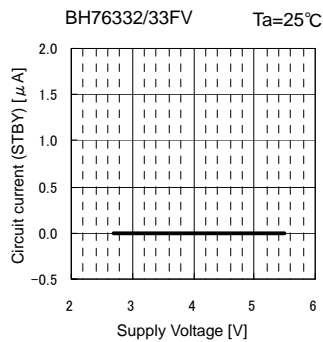

Fig.65 ICC2 vs. Supply Voltage

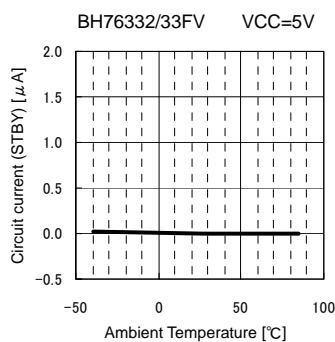

Fig.66 ICC2 vs. Ambient Temperature

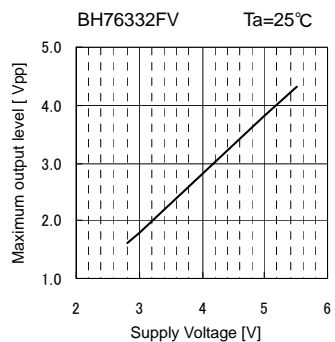

Fig.67 Vom vs. Supply Voltage

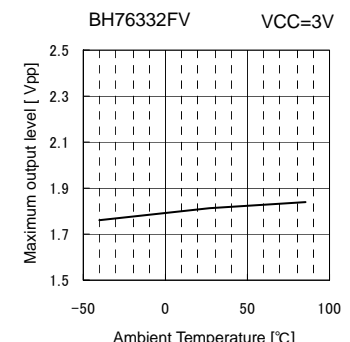

Fig.68 Vom vs. Ambient Temperature

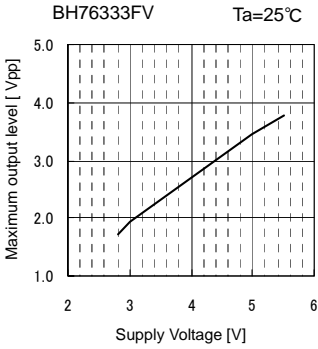

Fig.69 Vom vs. Supply Voltage

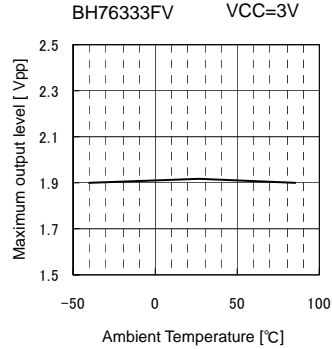

Fig.70 Vom vs. Ambient Temperature

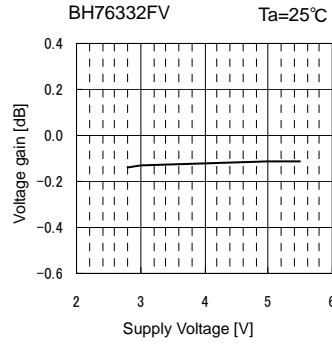

Fig.71 G<sub>v</sub> vs. Supply Voltage

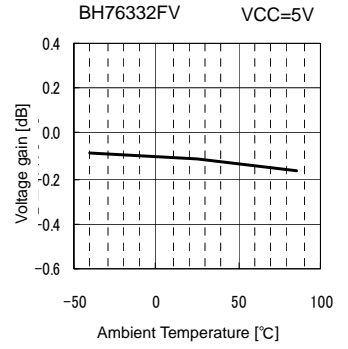

Fig.72 G<sub>v</sub> vs. Ambient Temperature

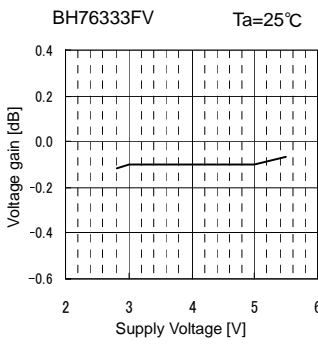

Fig.73 G<sub>v</sub> vs. Supply Voltage

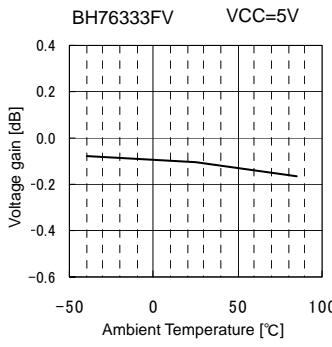

Fig.74 G<sub>v</sub> vs. Ambient Temperature

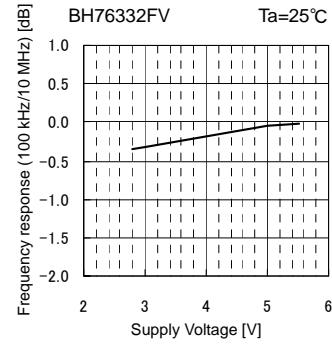

Fig.75 G<sub>f</sub> vs. Supply Voltage

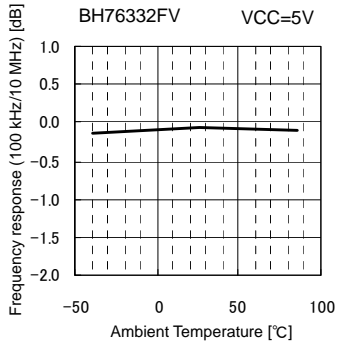

Fig.76 G<sub>f</sub> vs. Ambient Temperature

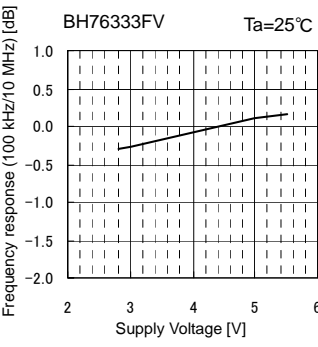

Fig.77 G<sub>f</sub> vs. Supply Voltage

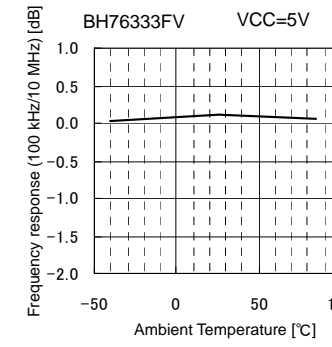

Fig.78 G<sub>f</sub> vs. Ambient Temperature

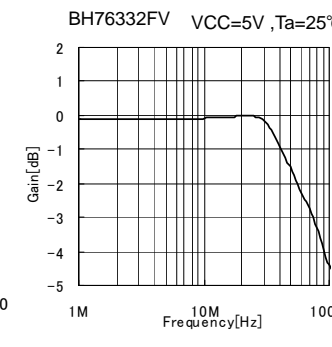

Fig.79 Frequency Response

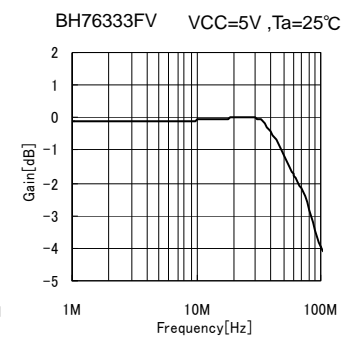

Fig.80 Frequency Response

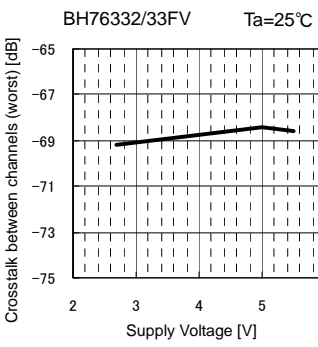

Fig.81 CT(worst) vs. Supply Voltage

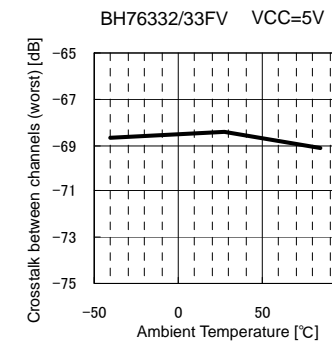

Fig.82 CT(worst) vs. Ambient Temperature

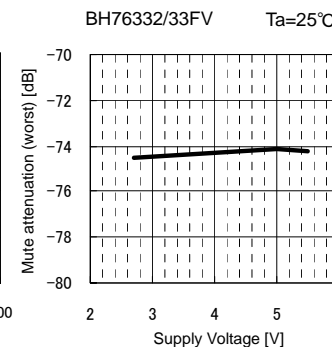

Fig.83 MT(worst) vs. Supply Voltage

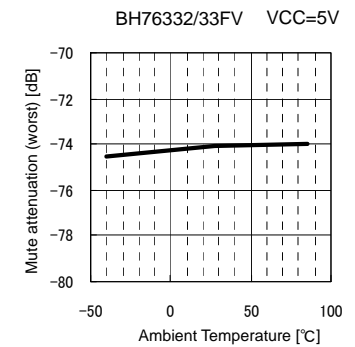

Fig.84 MT(worst) vs. Ambient Temperature

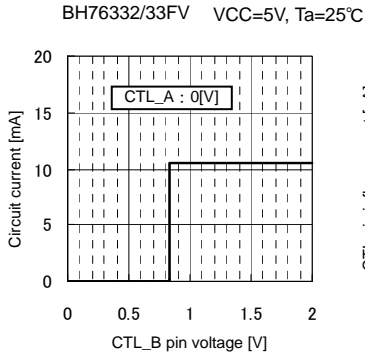

Fig.85 CTLb pin voltage vs Circuit Current (CLT threshold)

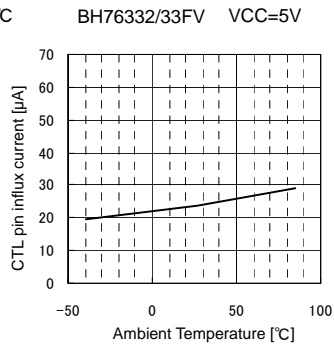

Fig.86  $I_{TH}$  vs. Ambient Temperature (Voltage applied to CTL pin = 2V)

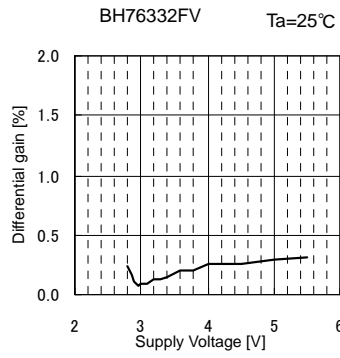

Fig.87 DG vs. Supply Voltage

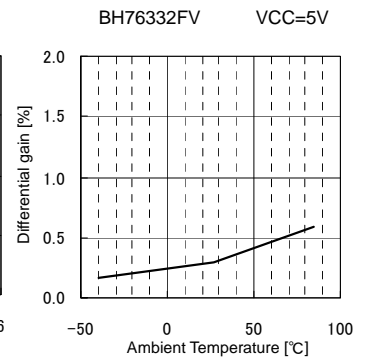

Fig.88 DG vs. Ambient Temperature

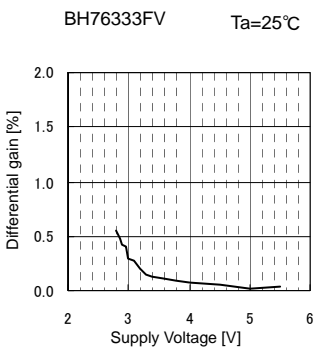

Fig.89 DG vs. Supply Voltage

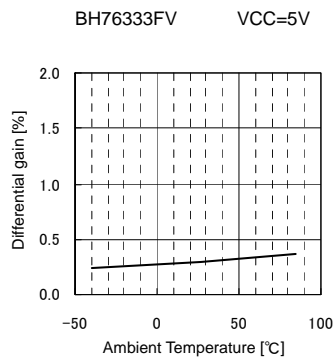

Fig.90 DG vs. Ambient Temperature

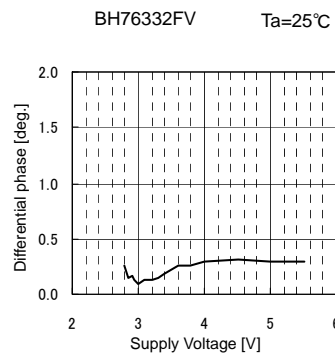

Fig.91 DP vs. Supply Voltage

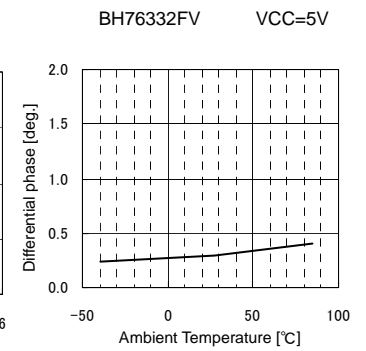

Fig.92 DP vs. Ambient Temperature

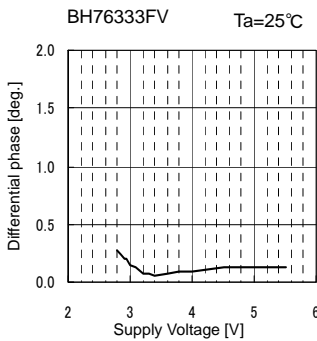

Fig.93 DP vs. Supply Voltage

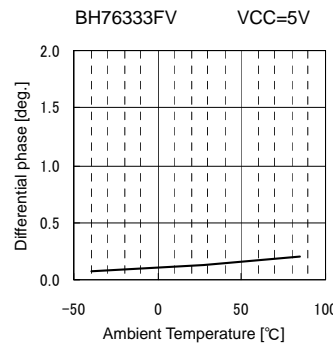

Fig.94 DP vs. Ambient Temperature

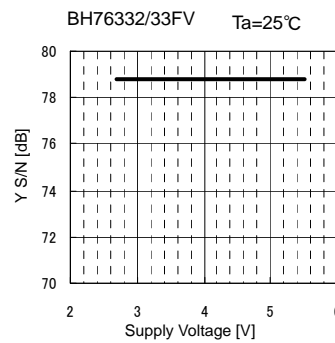

Fig.95  $SN_{\gamma}$  vs. Supply Voltage

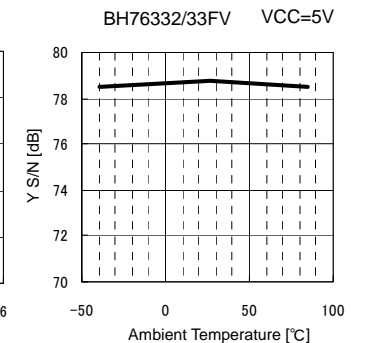

Fig.96  $SN_{\gamma}$  vs. Ambient Temperature

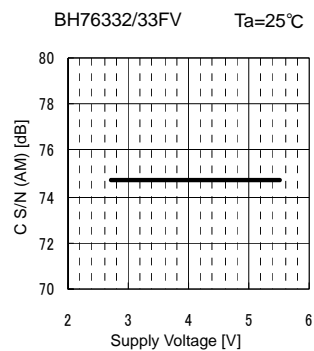

Fig.97  $SN_{CA}$  vs. Supply Voltage

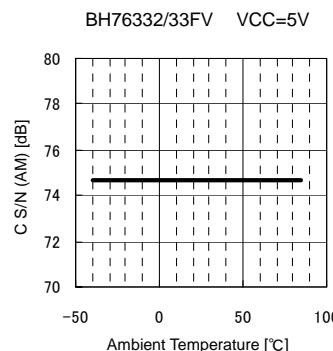

Fig.98  $SN_{CA}$  vs. Ambient Temperature

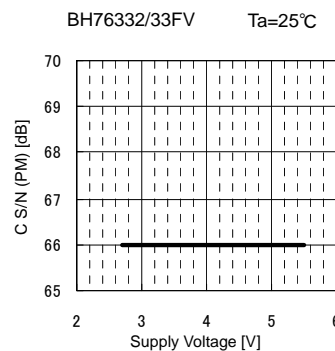

Fig.99  $SN_{CP}$  vs. Supply Voltage

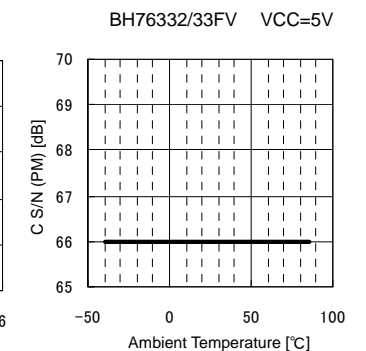

Fig.100  $SN_{CP}$  vs. Ambient Temperature



● External dimensions and label codes

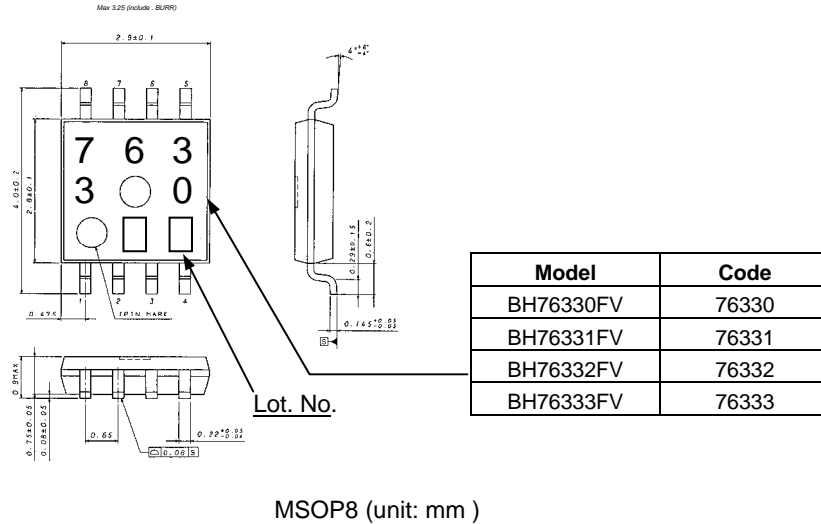

Fig. 101 External Dimensions of BH7633xFVM Series Package

● When used with 6-input, 1-output video switch BH7636xFV

Fig. 14 above shows an application example in which two of these ICs are used. When the similar IC models BH7636xFV and BH7633xFVM are used at the same time, the type of configuration shown below can be combined. In such cases, input coupling capacitors can be used, as in the application example in Fig. 14.

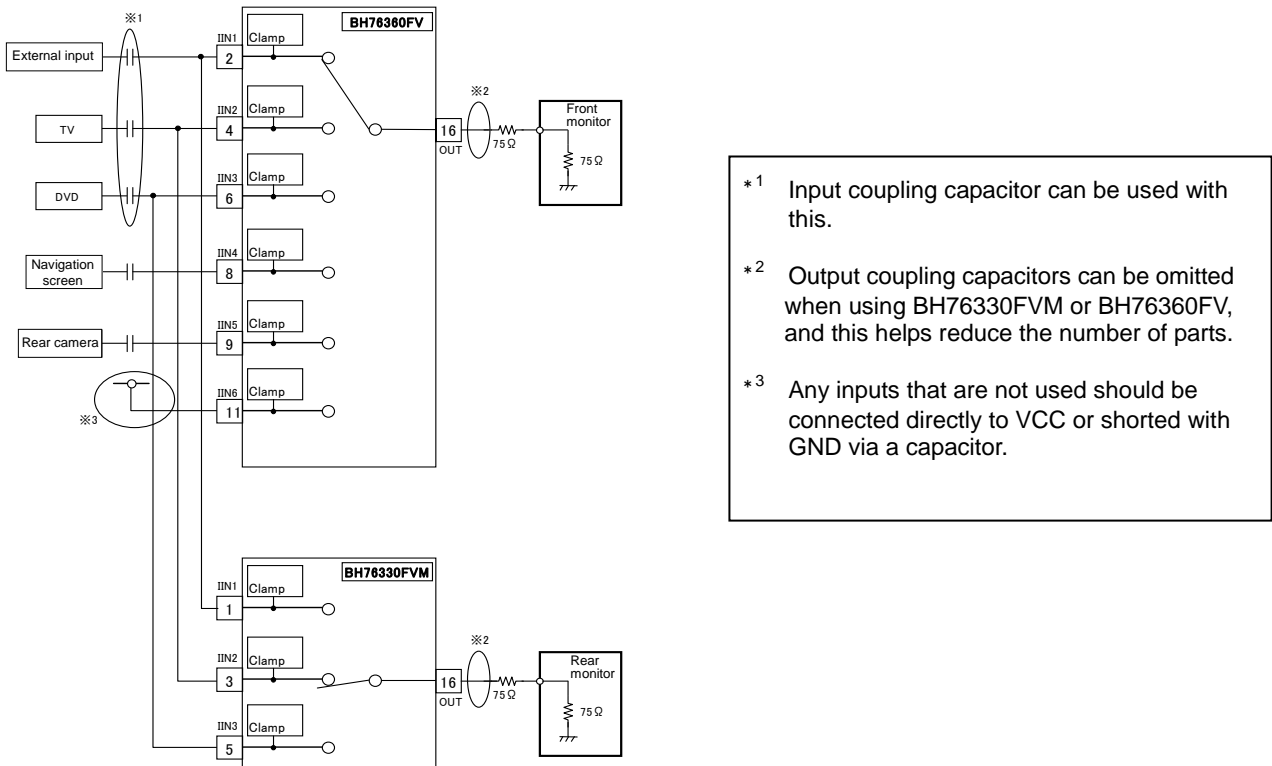

Fig. 102 Application Example in which BH76330FVM and BH76360FV Are Used Concurrently

For details of BH7636xFV, see the BH7636xFV Series Application Notes.



Line-up of products with built-in video amplifier and video driver

# 6-input, 1-output video switch

BH76360FV, BH76361FV, BH76362FV, BH76363FV

●General

BH76360FV, BH76361FV, BH76362FV, and BH76363FV are video signal switching ICs, each with six inputs and one circuit input, which feature wide dynamic range and frequency response. Since these ICs can be used with low voltage starting at VCC = 2.8 V, they are applicable not only in stationary devices but also in mobile devices.

This product line-up supports a broad range of input signals, depending on whether or not a 6-dB video amplifier and video driver are included and what combination of sync tip clamp type and bias (resistor termination) type inputs are used.

●Features

- 1) Able to use a wide range of power supply voltage, from 2.8 V to 5.5 V
- 2) Wide output dynamic range
- 3) Excellent frequency response  
(BH76360FV, BH76361FV : 100kHz/10MHz 0dB[Typ.], BH76362FV, BH76363FV : 100kHz/30MHz 0dB[Typ.])
- 4) No crosstalk between channels (Typ.-65dB, f=4.43MHz)
- 5) Built-in mute function (Typ.-65dB, f=4.43MHz)
- 6) Built-in standby function, circuit current during standby is 0 μA (Typ.)
- 7) Sync tip clamp input (BH76360FV, BH76362FV)
- 8) Bias input (Zin=150kΩ) (BH76361FV, BH76363FV)
- 9) 6-dB amp and 75Ω driver are built in (BH76360FV, BH76361FV)
- 10) Enables two load drivers [when using output coupling capacitor] (BH76360FV, BH76361FV)
- 11) Able to be used without output coupling capacitor (BH76360FV)
- 12) SSOP-B16 compact package

●Applications

Input switching in car navigation systems, TVs, DVD systems, etc.

●Line-up

	BH76360FV	BH76361FV	BH76362FV	BH76363FV
Supply voltage	2.8 V to 5.5 V			
Amp gain	6dB		-0.1dB	
Video driver	Included		-	
Frequency response	100kHz/10MHz 0dB (Typ.)		100kHz/30MHz 0dB (Typ.)	
Input type	Sync tip clamp	Bias (Zin = 150 kΩ)	Sync tip clamp	Bias (Zin = 150 kΩ)

●Absolute maximum ratings (Ta = 25°C)

Parameter	Symbol	Limits	Unit
Supply voltage	VCC	7.0	V
Power dissipation	Pd	450 *1	mW
Input voltage range	V <sub>IN</sub>	0 to VCC+0.2	V
Operating temperature range	Topr	-40 to +85	°C
Storage temperature range	Tstg	-55 to +125	°C

\*1 When used while Ta = 25°C, 4.7 mW is dissipated per 1°C Mounted on 70 mm x 70 mm x 1.6 mm glass epoxy board

●Operation range (Ta = 25°C)

Parameter	Symbol	Min.	Typ.	Max	Unit
Supply voltage	VCC	2.8	5.0	5.5	V

●Electrical characteristics 1 (unless otherwise specified, Ta=25°C, VCC=5V)

Parameter	Symbol	Typ.				Unit	Conditions
		76360	76361	76362	76363		
Circuit current 1	ICC1	12		11		mA	When no signal
Circuit current 2	ICC2	0.0				uA	During standby
Circuit current 3	ICC3-1	13		12		mA	During output of color bar signal
	ICC3-2	19	—				During output of color bar signal (no C in output)
Maximum output level	VOM	4.6		3.8	3.4	Vpp	f=10kHz, THD=1%
Voltage gain	G <sub>V</sub>	6.0		-0.1		dB	Vin=1.0Vpp, f=100kHz
Frequency response	G <sub>F1</sub>	0		—		dB	Vin=1.0Vpp, f=10MHz/100kHz
	G <sub>F2</sub>	—		0		dB	Vin=1.0Vpp, f=30MHz/100kHz
Crosstalk between channels	C <sub>T</sub>	-65				dB	Vin=1.0Vpp, f=4.43MHz
Mute attenuation	M <sub>T</sub>	-65				dB	Vin=1.0Vpp, f=4.43MHz
CTL pin switch level	V <sub>THH</sub>	1.2 <sub>Min</sub>				V	High Level threshold voltage
	V <sub>THL</sub>	0.45 <sub>Max</sub>				V	Low Level threshold voltage
CTL pin inflow current	I <sub>THH</sub>	50 <sub>Max</sub>				uA	CTL pin = 2.0 V applied
Input impedance	Z <sub>in</sub>	—	150	—	150	kΩ	
Differential gain	D <sub>G</sub>	0.3				%	Vin=1.0Vpp
Differential phase	D <sub>P-1</sub>	0.7		0.3		deg.	Standard stair step signal
	D <sub>P-2</sub>	0.0	—				Same condition as above (no C in output)
Y-related S/N	SN <sub>Y</sub>	+75		+78		dB	Vin = 1.0 Vpp, bandwidth: 100 k to 6 MHz 100% white video signal
C-related S/N [AM]	SN <sub>CA</sub>	+75				dB	Vin = 1.0 Vpp, bandwidth: 100 to 500 kHz 100% chroma voltage signal
C-related S/N [PM]	SN <sub>CP</sub>	+65					

●Electrical characteristics 2 (unless otherwise specified, Ta = 25°C, VCC = 3 V)

Parameter	Symbol	Typ.				Unit	Conditions
		76360	76361	76362	76363		
Circuit current 1	ICC1	10				mA	When no signal
Circuit current 2	ICC2	0.0				uA	During standby
Circuit current 3	ICC3-1	11		10		mA	During output of color bar signal
	ICC3-2	17	—				During output of color bar signal (no C in output)
Maximum output level	VOM	2.7	2.8	1.8	1.9	Vpp	f=10kHz, THD=1%
Voltage gain	G <sub>V</sub>	6.0		-0.1		dB	Vin=1.0Vpp, f=100kHz
Frequency response	G <sub>F1</sub>	0		—		dB	Vin=1.0Vpp, f=10MHz/100kHz
	G <sub>F2</sub>	—		0		dB	Vin=1.0Vpp, f=30MHz/100kHz
Crosstalk between channels	C <sub>T</sub>	-65				dB	Vin=1.0Vpp, f=4.43MHz
Mute attenuation	M <sub>T</sub>	-65				dB	Vin=1.0Vpp, f=4.43MHz
CTL pin switch level	V <sub>THH</sub>	1.2 <sub>Min</sub>				V	High Level threshold voltage
	V <sub>THL</sub>	0.45 <sub>Max</sub>				V	Low Level threshold voltage
CTL pin inflow current	I <sub>THH</sub>	50 <sub>Max</sub>				uA	CTL pin = 2.0 V applied
Input impedance	Z <sub>in</sub>	—	150	—	150	kΩ	
Differential gain	D <sub>G</sub>	0.3				%	Vin=1.0Vpp
Differential phase	D <sub>P-1</sub>	1.0		0.3		deg.	Standard stair step signal
	D <sub>P-2</sub>	0.5	—				Same condition as above (no C in output)
Y-related S/N	SN <sub>Y</sub>	+75		+78		dB	Vin = 1.0 Vpp, bandwidth: 100 k to 6 MHz 100% white video signal
C-related S/N [AM]	SN <sub>CA</sub>	+75				dB	Vin = 1.0 Vpp, bandwidth: 100 to 500 kHz 100% chroma video signal
C-related S/N [PM]	SN <sub>CP</sub>	+65					

(Note) Re: ICC3, VOM, G<sub>V</sub>, G<sub>F</sub>, C<sub>T</sub>, M<sub>T</sub>, D<sub>G</sub>, D<sub>P</sub>, SN<sub>Y</sub>, SN<sub>CA</sub>, SN<sub>CP</sub> parameters  
 BH76360FV, BH76361FV: RL = 150 Ω  
 BH76362FV, BH76363FV: RL = 10 kΩ

●Control pin settings

	CTLA	CTLB	CTLC	CTLD
IN1	L(OPEN)	L(OPEN)	L(OPEN)	H
IN2	H	L(OPEN)	L(OPEN)	H
IN3	L(OPEN)	H	L(OPEN)	H
IN4	H	H	L(OPEN)	H
IN5	L(OPEN)	L(OPEN)	H	H
IN6	H	L(OPEN)	H	H
MUTE	*	H	H	H
STBY	*	*	*	L(OPEN)

\* L(OPEN) or H either is possible

●Block diagram

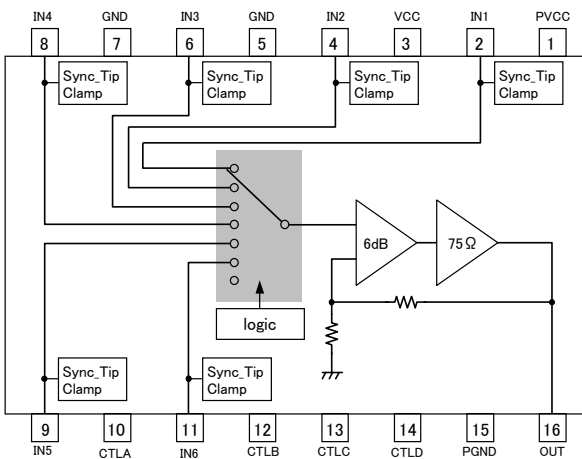

Fig.1 BH76360FV

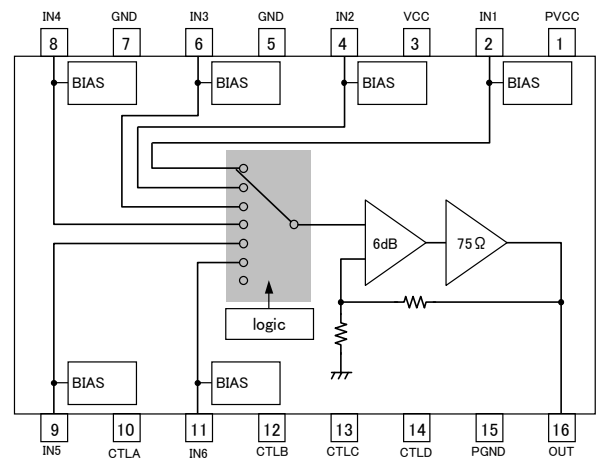

Fig.2 BH76361FV

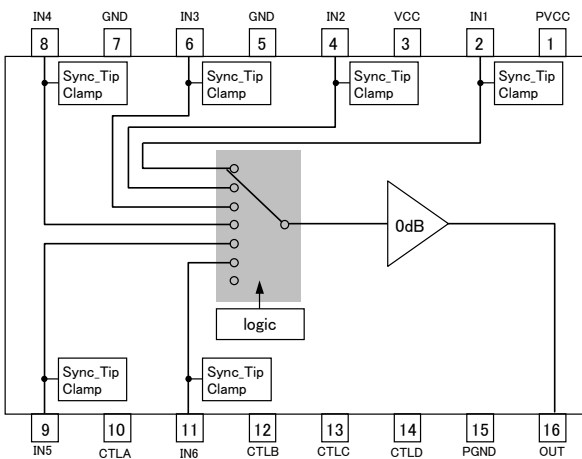

Fig.3 BH76362FV

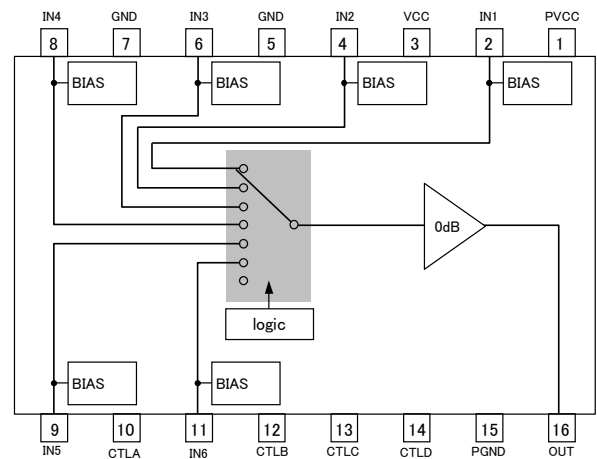

Fig.4 BH76363FV

● I/O equivalent circuit diagrams

Input pins

Sync tip clamp input BH76360FV / BH76362FV			Bias input BH76361FV / BH76363FV		
PIN No.	Name	Equivalent circuit	PIN No.	Name	Equivalent circuit
2	IN1		2	IN1	
4	IN2				
6	IN3				
8	IN4				
9	IN5				
11	IN6				
Video signal input pin is used for sync tip clamp input. • DC potential BH76360FV : 1.5V      BH76362FV : 1.0V			Video signal input pin is used for bias type input. Input impedance is 150 kΩ. • DC potential BH76361FV : 3.1V      BH76363FV : 2.5V		

Control pins

PIN No.	Name	Equivalent circuit
10	CTLA	
12	CTLB	
13	CTLC	
14	CTLD	
Switches operation mode [active or standby] and input pin. Threshold level is 0.45 V to 1.2 V.		

Output pin

With video driver BH76360FV / BH76361FV			Without video driver BH76362FV / BH76363FV		
PIN No.	Name	Equivalent circuit	PIN No.	Name	Equivalent circuit
16	OUT		16	OUT	
Video signal output pin. Able to drive loads up to 75 Ω (dual drive). • DC potential BH76360FV : 0.16V      BH76361FV : 2.5V			Video signal output pin. • DC potential BH76362FV : 0.3V      BH76363FV : 1.8V		

Note 1) The above DC potential is only when VCC = 5 V. This value is a reference value and is not guaranteed.

Note 2) Numerical values shown in these figures are design values, and compliance to standards is not guaranteed.

● Test Circuit Diagrams

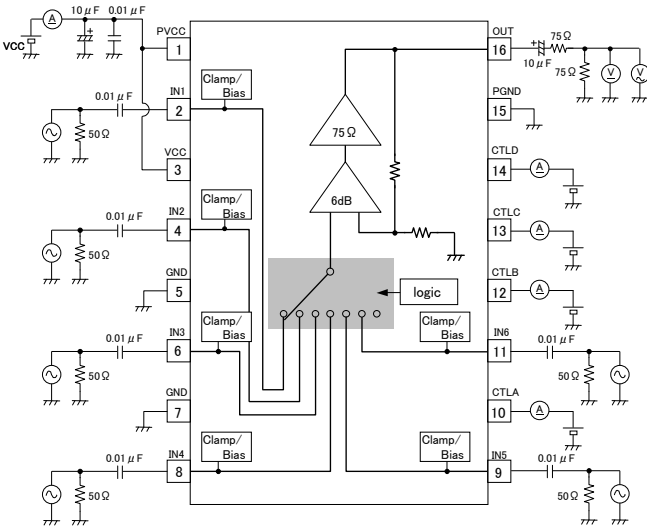

Fig.5 BH76360FV/BH76361FV Test Circuit Diagram

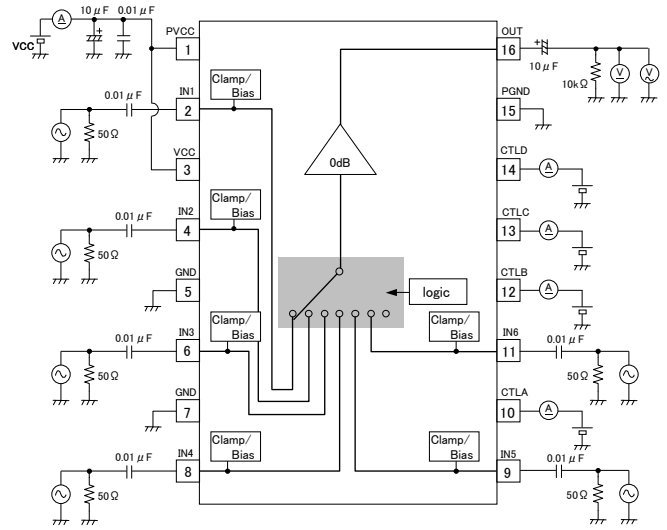

Fig.6 BH76362FV/BH76363FV Test Circuit Diagram

Test circuit diagrams are used for shipment inspections, and differ from application circuits.

● Application circuit examples

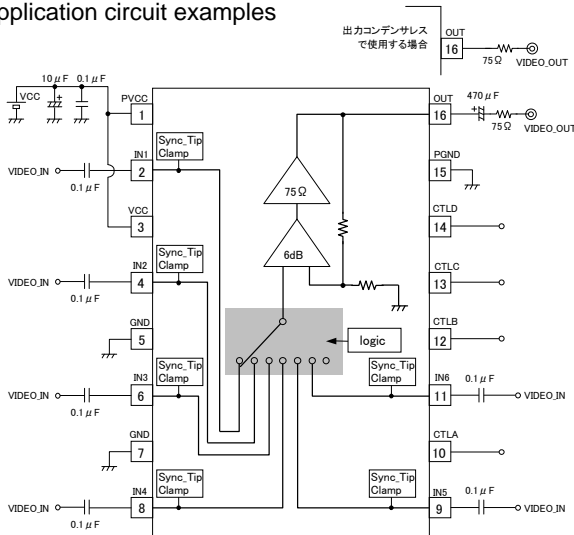

Fig.7 BH76360FV

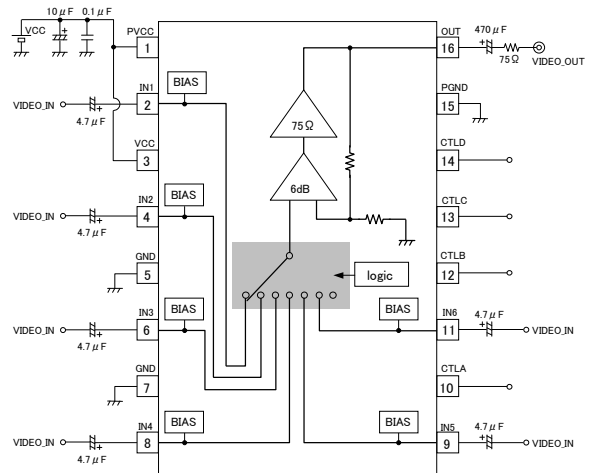

Fig.8 BH76361FV

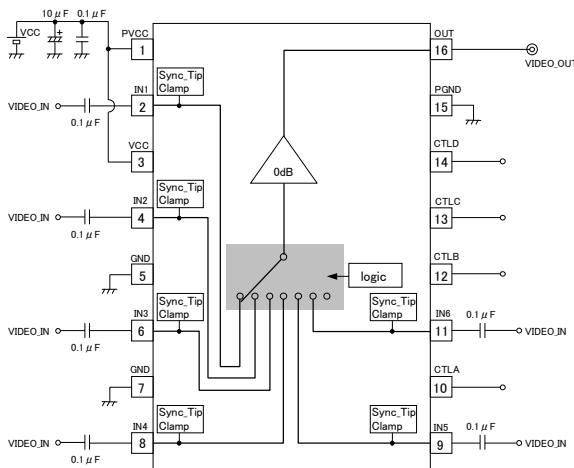

Fig.9 BH76362FV

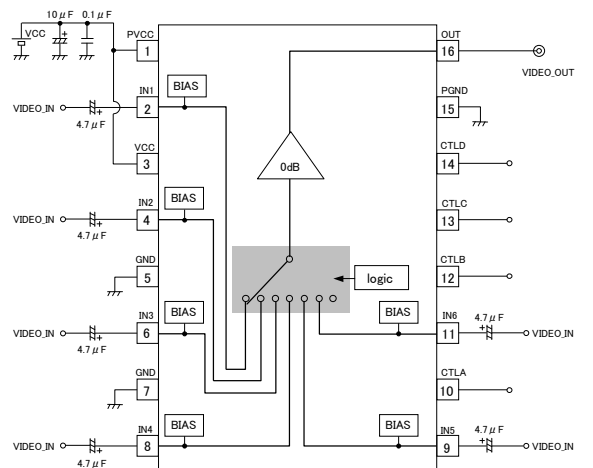

Fig.10 BH76363FV

See pages 6/16 to 10/16 for description of how to determine the capacity of I/O coupling capacitors.

●Cautions for selection and use of application parts

When using this IC by itself ①

Input type	Input impedance Zin	Capacity of input coupling capacitor (recommended value)	Capacity of output coupling capacitor (recommended value)
Sync_Tip_Clamp	10MΩ	0.1uF	470uF~1000uF
Bias	150kΩ	4.7uF	

Method for determining capacity of input coupling capacitor

The HPF is comprised of an input coupling capacitor and the internal input impedance Zin of the IC. Since the fc value of this HPF is determined using the following equation (a), the above recommended capacity for the input capacitor is derived. Usually, the cutoff frequency fc is several Hz.

$$f_c = 1 / (2\pi \times C \times Z_{in}) \dots (a)$$

When evaluating the sag characteristics and determining the capacity of the capacitor during video signal input, a horizontal stripe signal called "H bar" (shown in Fig. 10) is suitable, and this type of signal is used instead of a color bar signal to evaluate characteristics and determine capacity.



Fig.11 Example of Screen with Obvious Sag (H-bar Signal)

Method for determining capacity of output coupling capacitor

The output pins of models with a 75Ω driver [BH76360FV and BH76361FV] have an HPF comprised of an output coupling capacitor and load resistance RL (= 150Ω). When fc is set to approximately 1 Hz or 2 Hz, the capacity of the output coupling capacitor needs to be approximately 470 μF to 1000 μF.

As for models without the 75Ω driver, an HPF is similarly comprised using the capacity of the output coupling capacitor and the input impedance of the IC connected at the next stage, and the capacitance required for the output coupling capacitor should be estimated using equation (a).

When this IC is used as a standalone device ②

In models that include a 75Ω driver [BH76360FV and BH76361FV], up to two monitors (loads) can be connected (a connection example is shown in Fig. 12). When there are multiple loads, the number of output coupling capacitors must be increased or a larger capacitance must be used, based on the table shown below.

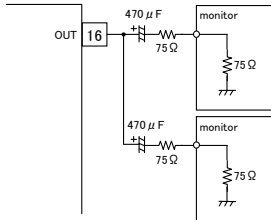

Fig. 12 (a) Application Circuit Example 1 (Two Drives)

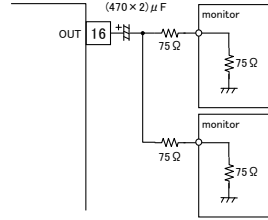

Fig. 12 (b) Application Circuit Example 2 (Two Drives)

Application circuit example	No. of output capacitors	Capacitance per output capacitor (recommended values)
Fig12(a)	No. of drives required	470 μF to 1000 μF (same as with one drive)
Fig12(b)	1	(No. of drive × 470 μF to 1000) uF

When this IC is used as a standalone device ③

The BH76360FV is the only model that can be used without an output coupling capacitor.

This use method not only enables reductions in board space and part-related costs, but it is able to improve the sag characteristics by improving low-range frequency response. However, when the output coupling capacitor is omitted, a direct current flows to the connected set, so the specifications of the connected set should be noted carefully before starting use.

Note also that only one load can be connected when the output coupling capacitor is omitted.

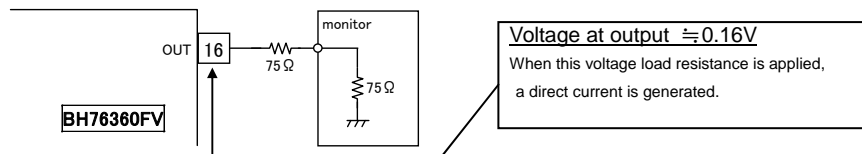

Fig.13 Application Example without Output Coupling Capacitor

**When using several of these ICs ①**

When several of these ICs are used, it enables applications in which separate images are output to the car navigation system's front and rear monitors.

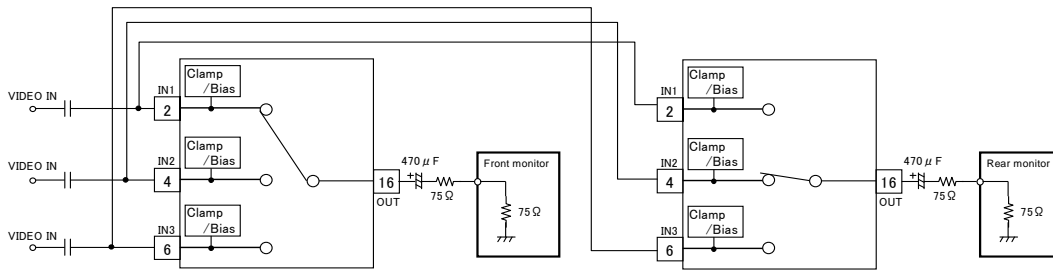

Fig.14 Application Example when Using Several ICs

When several ICs are used at the same time, the number of parallel connections of input impedance equals the number of ICs being used, which reduces the input impedance. This also raises the  $f_c$  value of the HPF formed at the input pin block, so the capacitance of the input coupling capacitor must be increased according to equation (a). The recommended values for calculation results are listed in the table below.

When a clamp is used as the input type, the original input impedance becomes much greater, and if two or three are used at the same time there is no need to change the capacitance of the input coupling capacitor.

Input type	Input impedance per IC	Number of ICs used	Total input impedance	Capacitance of input coupling capacitor (recommended values)
Sync_Tip_Clamp	Approx. 10 MΩ	2	Approx. 5 MΩ	0.1uF
		3	Approx. 3 MΩ	0.1uF
Bias	150k Ω	2	75k Ω	6.8uF~
		3	50k Ω	10uF~

**When using several of these ICs ②**

When three bias input type models (BH76361FV or BH76363FV) are used in parallel, they can be used for RGB signal switching applications. Likewise, when one clamp input type model (BH76360FV or BH76362FV) is connected in parallel with two bias input type models (a total of three ICs used in parallel), they can be used for component signal switching applications. The same method can be used to determine the capacitance of I/O coupling capacitors of these applications.

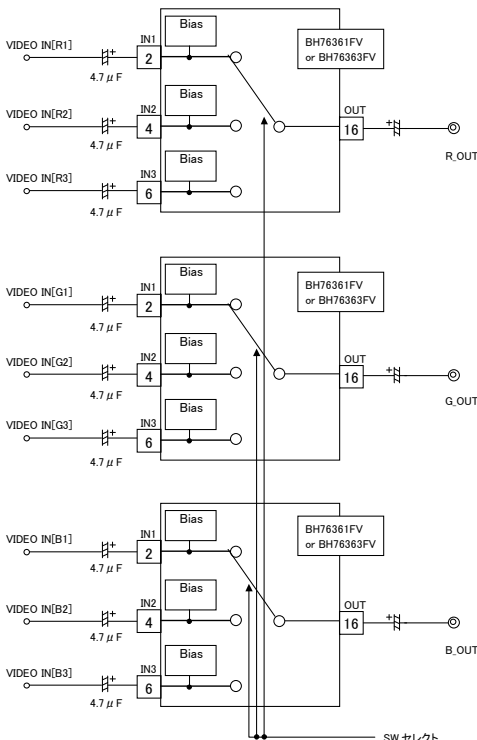

Fig. 15 (a). RGB Signal Switching Application Example (using three bias input type models in parallel)

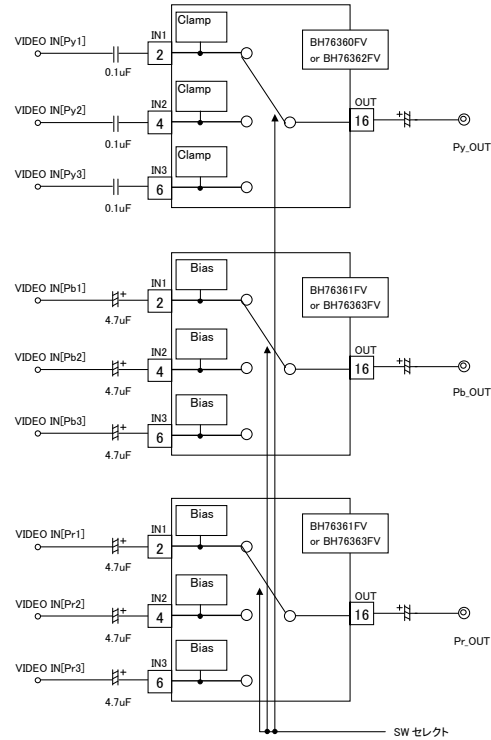

Fig. 15 (b). Component Signal Switching Application Example (using one clamp input type model and two bias input type models in parallel)

●Cautions for use

1. The numerical values and data shown here are typical design values, not guaranteed values.
2. The application circuit examples show recommended circuits, but characteristics should be checked carefully before using these circuits. If any external part constants are modified before use, factors such as variation in all external parts and ROHM LSI ICs, including not only static characteristics but also transient characteristics, should be fully considered to set an ample margin.
3. Absolute maximum ratings  
If the absolute maximum ratings for applied voltage and/or operation temperature are exceeded, LSI damage may result. Therefore, do not apply voltage or use in a temperature that exceeds these absolute maximum ratings. If it is possible that absolute maximum ratings will be exceeded, use a physical safety device such as a fuse and make sure that no conditions that might exceed the absolute maximum ratings will be applied to the LSI IC.
4. GND potential  
Regardless of the operation mode, the voltage of the GND pin should be at least the minimum voltage. Actually check whether or not the voltage at each pin, including transient phenomena, is less than the GND pin voltage.
5. Thermal design  
The thermal design should be done using an ample margin that takes into consideration the allowable dissipation under actual use conditions.
6. Shorts between pins and mounting errors  
When mounting LSI ICs onto the circuit board, make sure each LSI's orientation and position is correct. The ICs may become damaged if they are not mounted correctly when the power is turned on. Similarly, damage may also result if a short occurs, such as when a foreign object is positioned between pins in an IC, or between a pin and a power supply or GND connection.
7. Operation in strong electromagnetic field  
When used within a strong electromagnetic field, evaluate carefully to avoid the risk of operation faults.
8. Place the power supply's decoupling capacitor as close as possible to the VCC pin (PIN 1, PIN3) and GND pin (PIN 5, PIN7, PIN15).
9. With a clamp input type model (BH76360FV or BH76362FV), if any unused input pins are left open they will oscillate, so unused input pins should instead be connected to GND via a capacitor or else directly connected to VCC.
10. With models that do not include a 75Ω driver (BH76362FV or BH76363FV), in some cases the capacitance added to the set board may cause the peak frequency response to occur at a high frequency. To lower the peak frequency, connect in series resistors having resistance of several dozen Ω to several hundred Ω as close as possible to the output pin.

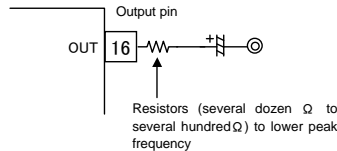

Fig.16 Positions where Resistors are Inserted to Lower Peak Frequency Response in BH76362FV or BH76363FV

11. Frequency response in models that do not include a 75-Ω driver (BH76362FV and BH76363FV) was measured as 100 kHz/30 MHz: 0 dB (Typ.) in the application circuit examples (shown in Fig. 9 and Fig. 10), and when resistance of about 1 or 2 kΩ is applied from the IC's output pin to GND, this frequency response can be improved (the lower limit of the applied resistance should be 1 kΩ). In such cases, gain is reduced, since the output voltage is divided by the added resistance and the output resistance of the IC.

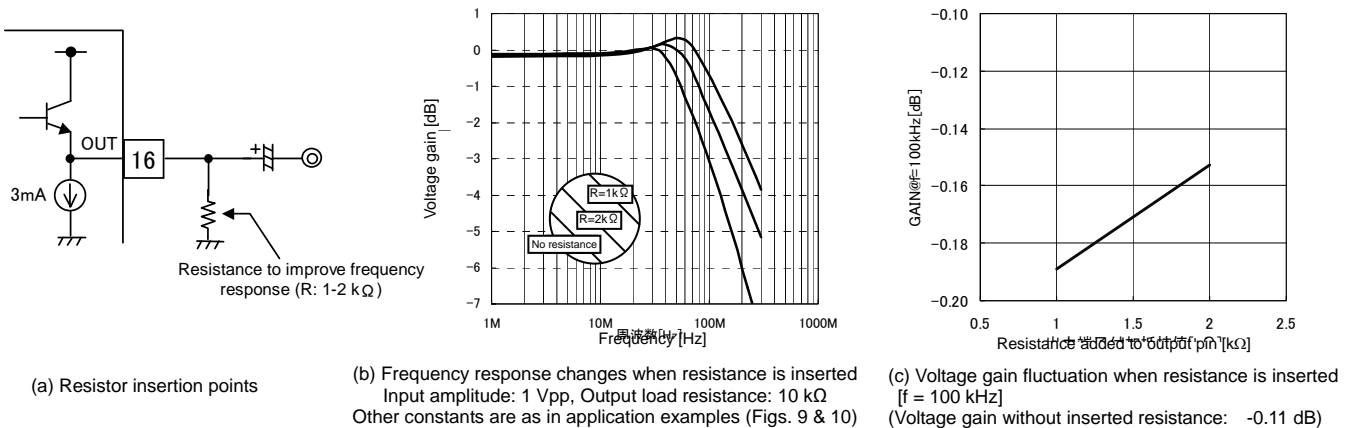

Fig.17 Result of Resistance Inserted to Improve BH76362FV/BH76363FV Frequency Response



12. With clamp input type models (BH76360FV and BH76362FV), if the termination impedance of the video input pin becomes higher, sync contractions or oscillation-related problems may occur. Evaluate temperature and other characteristics carefully and use at 1 kΩ or less.

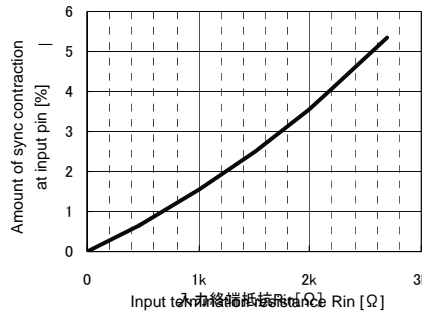

Fig. 18. Relation between Input Pin Termination Impedance and Amount of Sync Contraction

● Evaluation board pattern diagram and circuit diagram

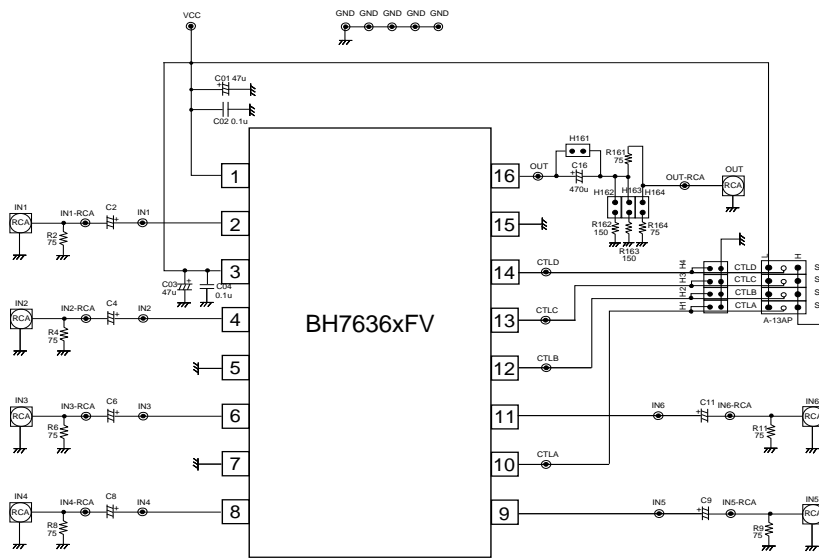

Fig.19 Evaluation Board Circuit Diagram

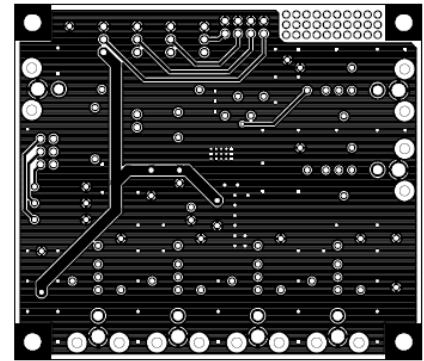
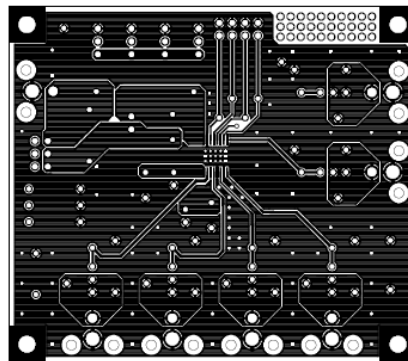
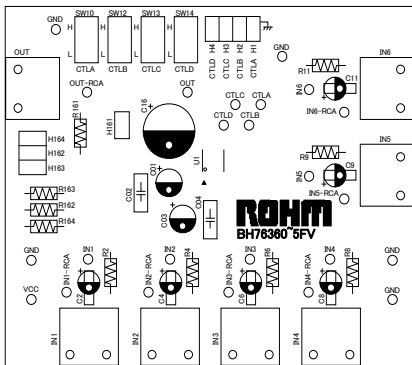

Fig.20 Evaluation Board Pattern Diagram

Parts list

Symbol	Function	Recommended value	Comments
R2 R4 R6 R8 R9 R11	Input terminating resistor	75Ω	—
C2 C4 C6 C8 C9 C11	Input coupling capacitor	See pages 6/16 to 7/16 to determine	B characteristics recommended
R161	Output resistor	75Ω	—
C16	Output coupling capacitor	See pages 6/16 to 7/16 to determine	B characteristics recommended
C01(C03) C02(C04)	Decoupling capacitor	10uF 0.1uF	B characteristics recommended

● Reference data (1) BH76360FV / BH76361FV [unless otherwise specified, output capacitance C: 470  $\mu$ F, RL = 150  $\Omega$ ]

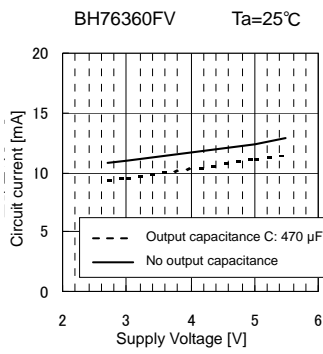

Fig.21 ICC1 vs. Supply Voltage

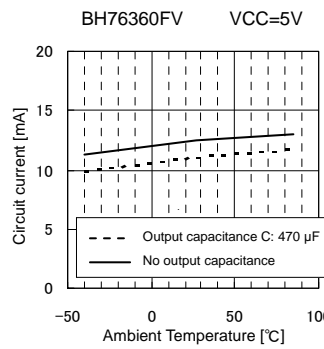

Fig.22 ICC1 vs. Ambient Temperature

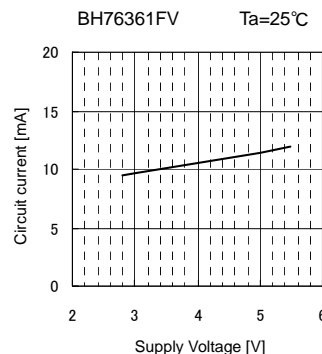

Fig.23 ICC1 vs. Supply Voltage

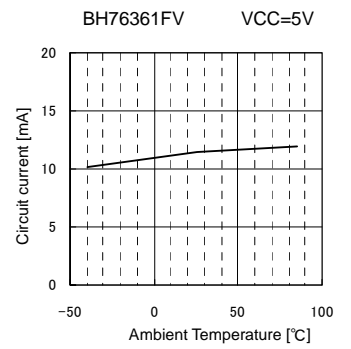

Fig.24 ICC1 vs. Ambient Temperature

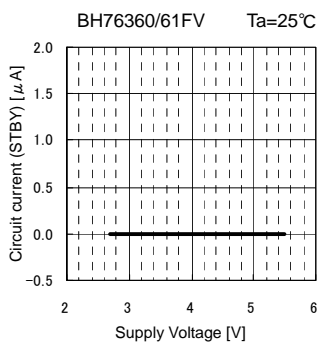

Fig.25 ICC2 vs. Supply Voltage

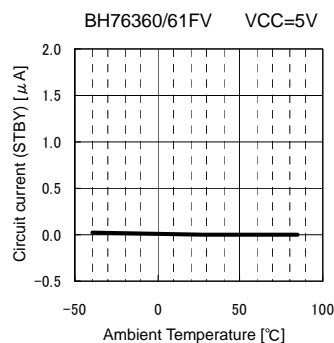

Fig.26 ICC2 vs. Ambient Temperature

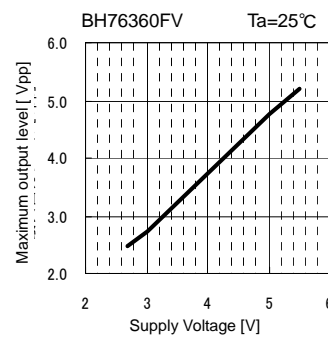

Fig.27 Vom vs. Supply Voltage

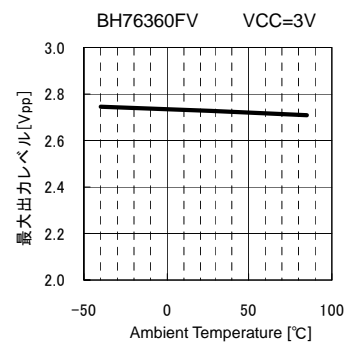

Fig.28 Vom vs. Ambient Temperature

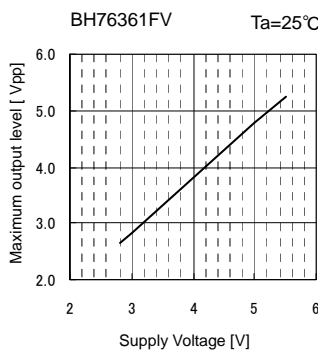

Fig.29 Vom vs. Supply Voltage

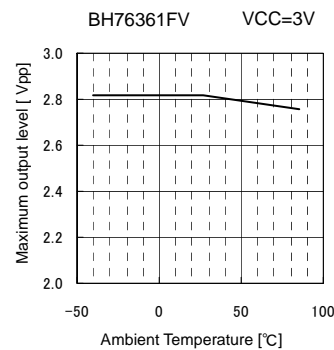

Fig.30 Vom vs. Ambient Temperature

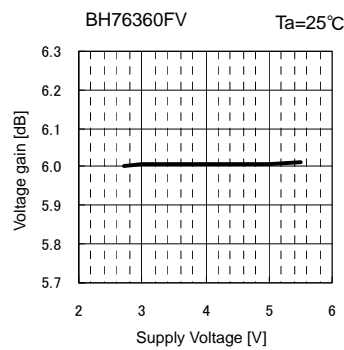

Fig.31 G<sub>v</sub> vs. Supply Voltage

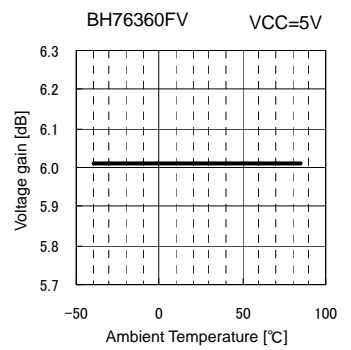

Fig.32 G<sub>v</sub> vs. Ambient Temperature

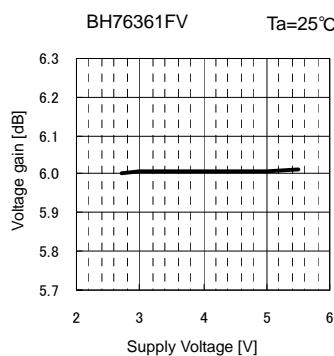

Fig.33 G<sub>v</sub> vs. Supply Voltage

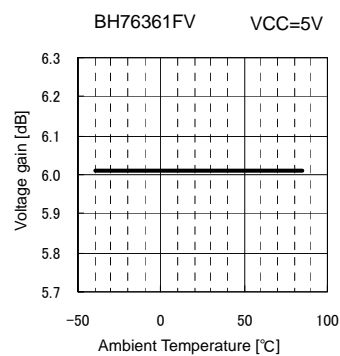

Fig.34 G<sub>v</sub> vs. Ambient Temperature

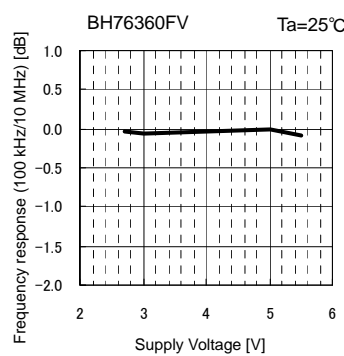

Fig.35 G<sub>f</sub> vs. Supply Voltage

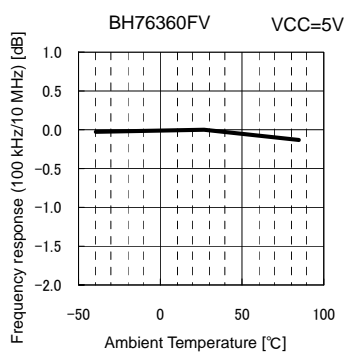

Fig.36 G<sub>f</sub> vs. Ambient Temperature

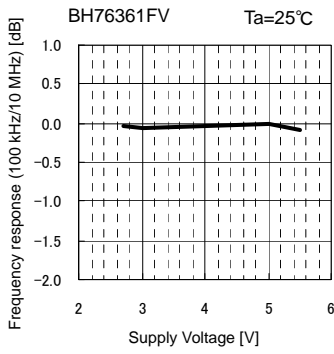

Fig.37  $G_F$  vs. Supply Voltage

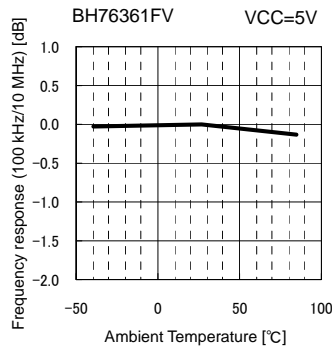

Fig.38  $G_F$  vs. Ambient Temperature

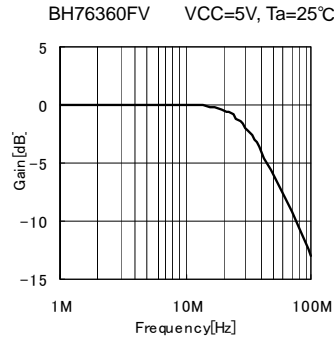

Fig.39 Frequency Response

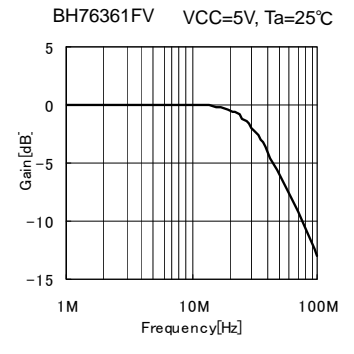

Fig.40 Frequency Response

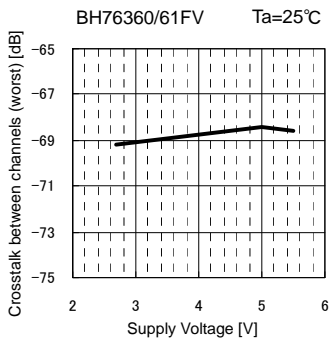

Fig.41 CT(worst) vs. Supply Voltage

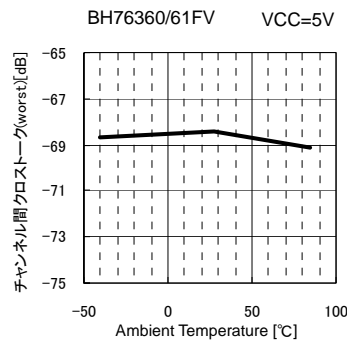

Fig.42 CT(worst) vs. Ambient Temperature

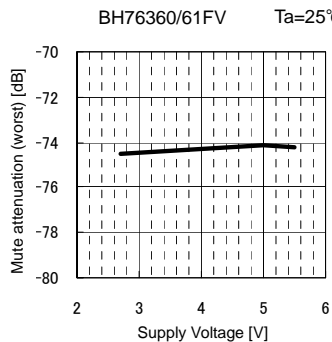

Fig.43 MT(worst) vs. Supply Voltage

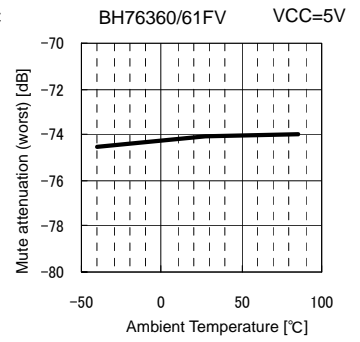

Fig.44 MT(worst) vs. Ambient Temperature

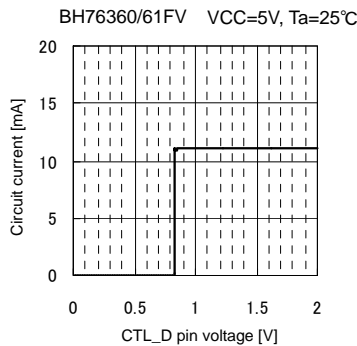

Fig.45 CTLd pin voltage vs Circuit Current (CLT threshold)

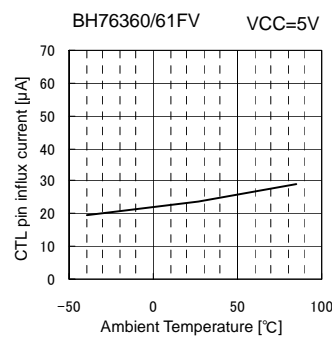

Fig.46  $I_{THH}$  vs. Ambient Temperature (Voltage applied to CTL pin = 2V)

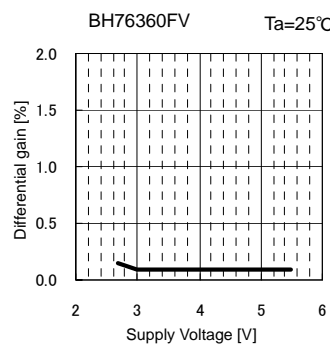

Fig.47 DG vs. Supply Voltage

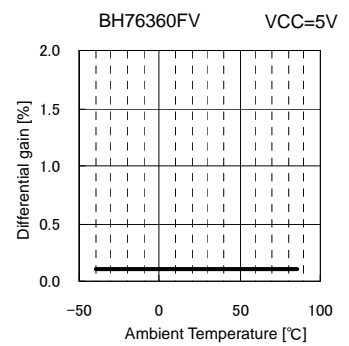

Fig.48 DG vs. Ambient Temperature

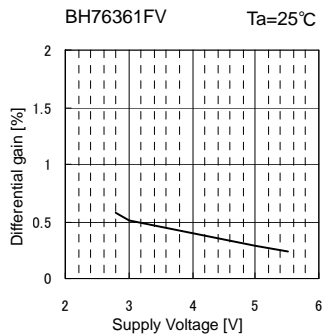

Fig.49 DG vs. Supply Voltage

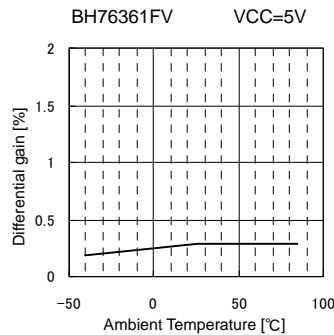

Fig.50 DG vs. Ambient Temperature

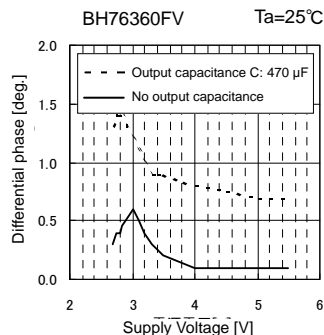

Fig.51 DP vs. Supply Voltage

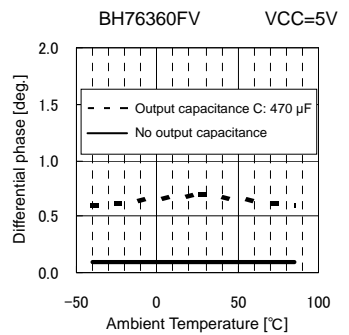

Fig.52 DP vs. Ambient Temperature

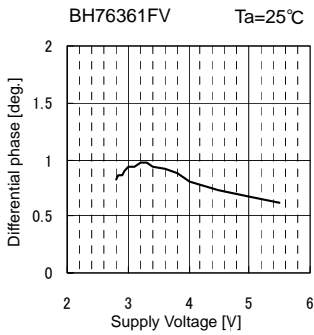

Fig.53 DP vs. Supply Voltage

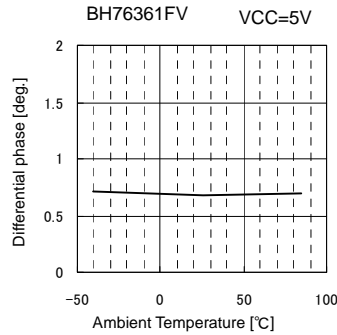

Fig.54 DP vs. Ambient Temperature

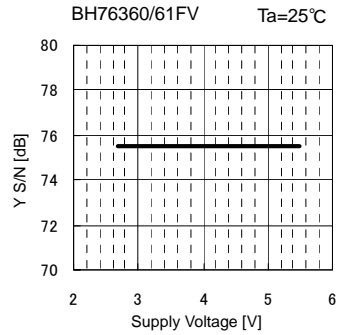

Fig.55  $SN_{\gamma}$  vs. Supply Voltage

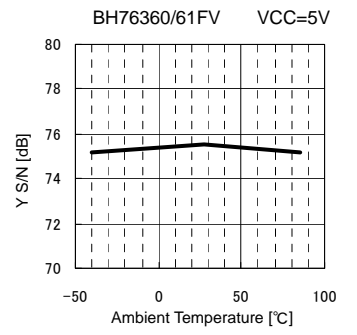

Fig.56  $SN_{\gamma}$  vs. Ambient Temperature

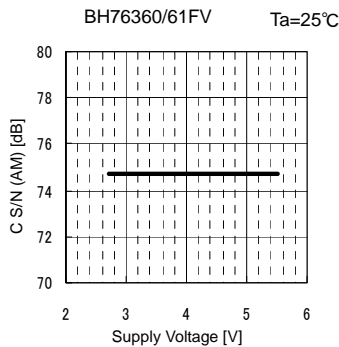

Fig.57  $SN_{CA}$  vs. Supply Voltage

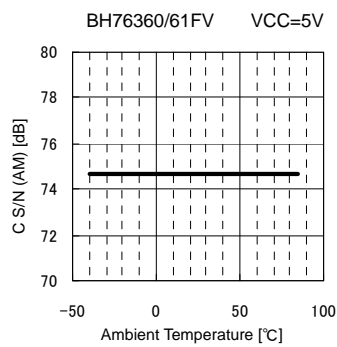

Fig.58  $SN_{CA}$  vs. Ambient Temperature

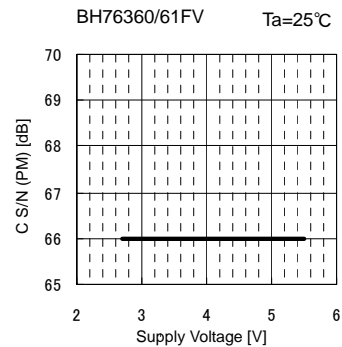

Fig.59  $SN_{CP}$  vs. Supply Voltage

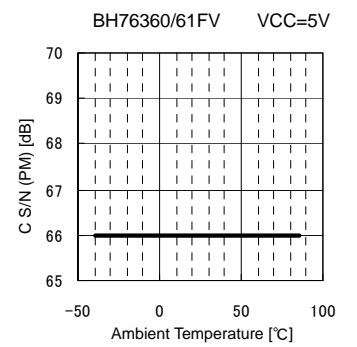

Fig.60  $SN_{CP}$  vs. Ambient Temperature

● Reference data (2) BH76362FV/BH76363FV [unless otherwise specified, output capacitance C: 470  $\mu$ F,  $R_L = 10$  k $\Omega$ ]

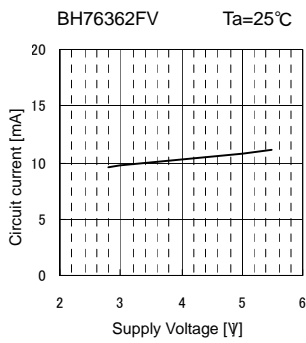

Fig.61  $ICC_1$  vs. Supply Voltage

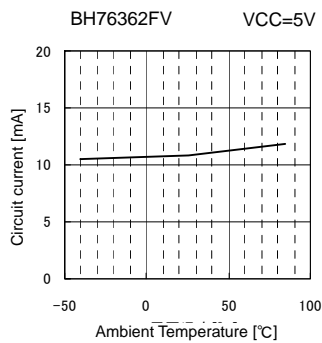

Fig.62  $ICC_1$  vs. Ambient Temperature

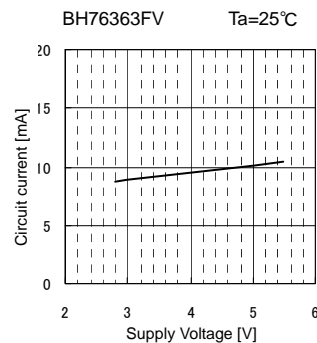

Fig.63  $ICC_1$  vs. Supply Voltage

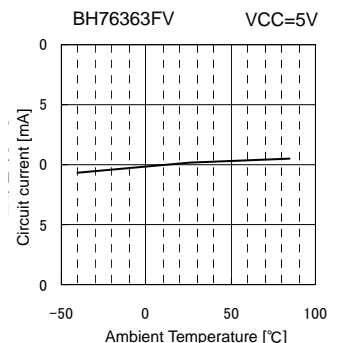

Fig.64  $ICC_1$  vs. Ambient Temperature

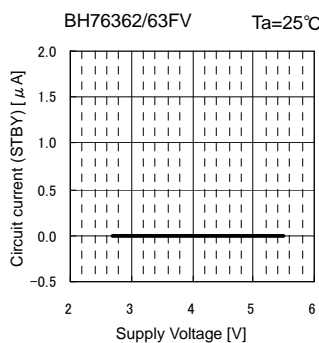

Fig.65  $ICC_2$  vs. Supply Voltage

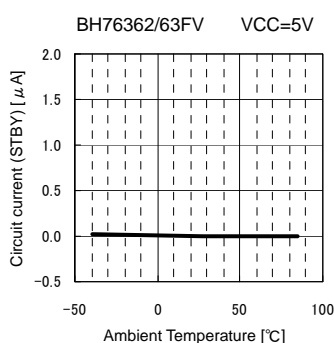

Fig.66  $ICC_2$  vs. Ambient Temperature

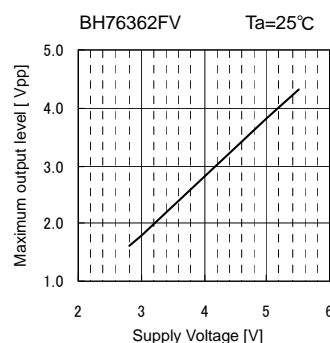

Fig.67  $V_{om}$  vs. Supply Voltage

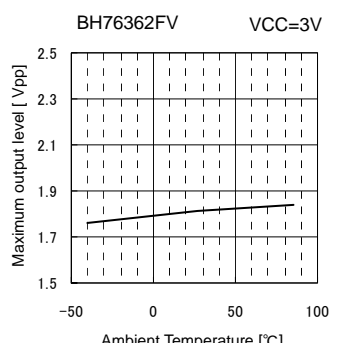

Fig.68  $V_{om}$  vs. Ambient Temperature

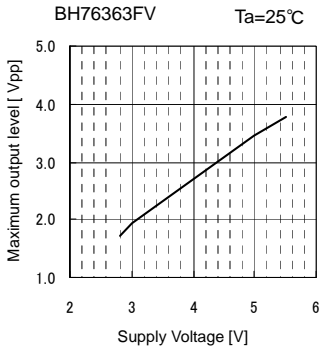

Fig.69 Vom vs. Supply Voltage

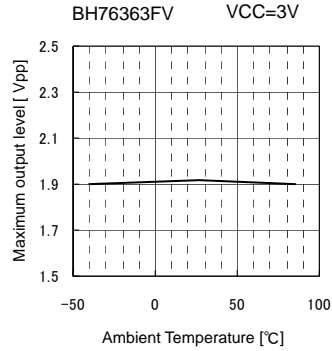

Fig.70 Vom vs. Ambient Temperature

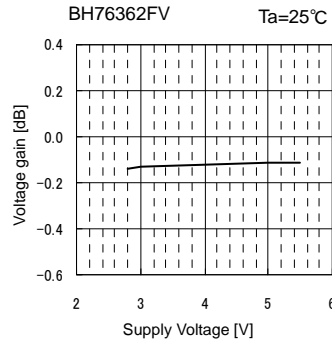

Fig.71 G<sub>V</sub> vs. Supply Voltage

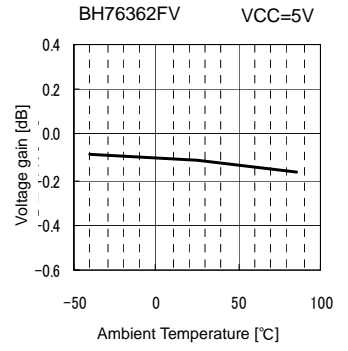

Fig.72 G<sub>V</sub> vs. Ambient Temperature

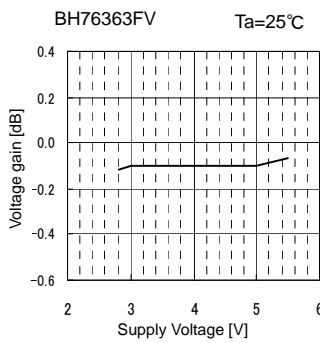

Fig.73 G<sub>V</sub> vs. Supply Voltage

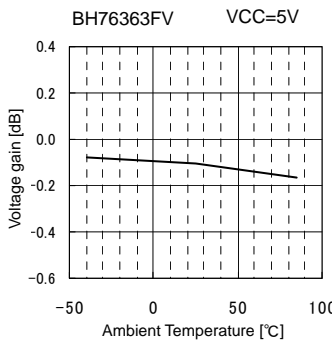

Fig.74 G<sub>V</sub> vs. Ambient Temperature

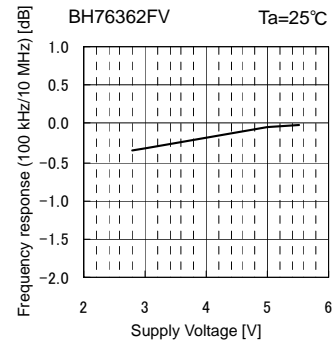

Fig.75 G<sub>F</sub> vs. Supply Voltage

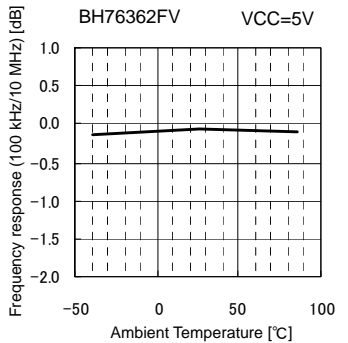

Fig.76 G<sub>F</sub> vs. Ambient Temperature

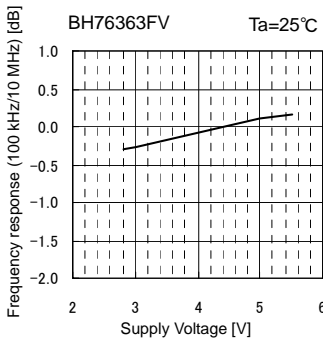

Fig.77 G<sub>F</sub> vs. Supply Voltage

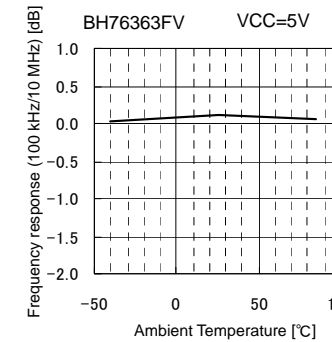

Fig.78 G<sub>F</sub> vs. Ambient Temperature

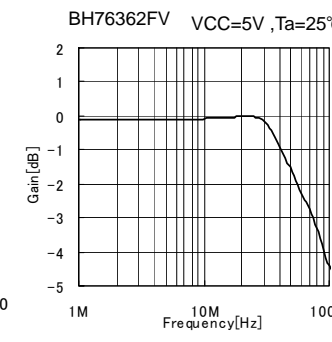

Fig.79 Frequency Response

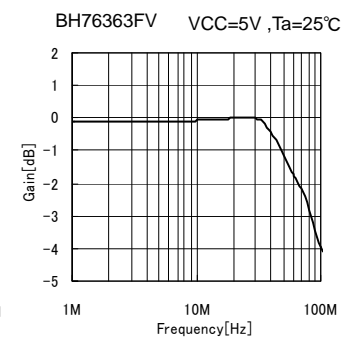

Fig.80 Frequency Response

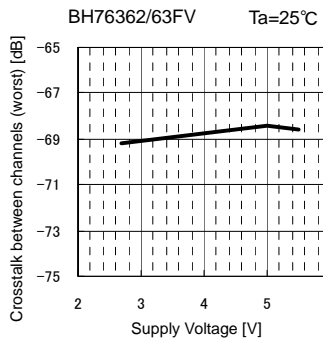

Fig.81 CT(worst) vs. Supply Voltage

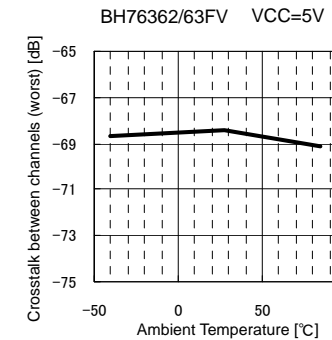

Fig.82 CT(worst) vs. Ambient Temperature

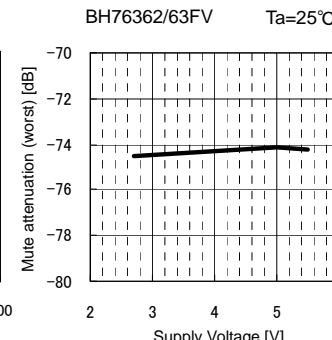

Fig.83 MT(worst) vs. Supply Voltage

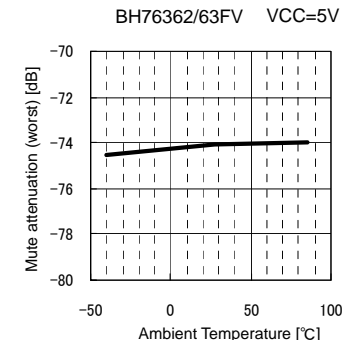

Fig.84 MT(worst) vs. Ambient Temperature

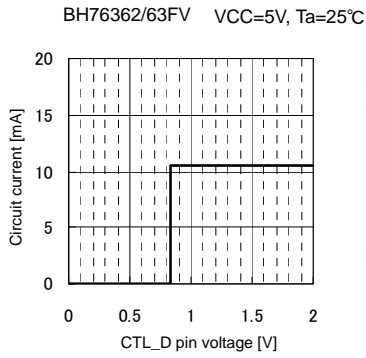

Fig.85 CTLd pin voltage vs Circuit Current (CLT threshold)

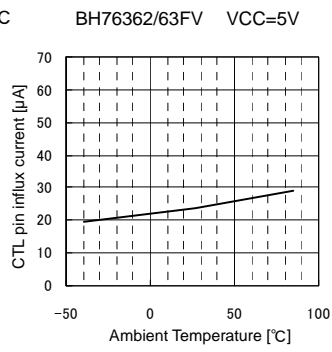

Fig.86  $I_{TH}$  vs. Ambient Temperature (Voltage applied to CTL pin = 2V)

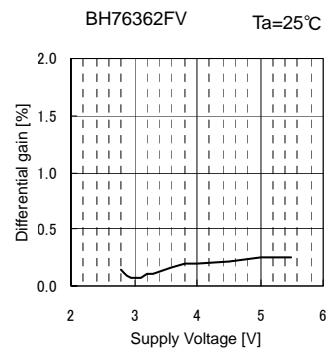

Fig.87 DG vs. Supply Voltage

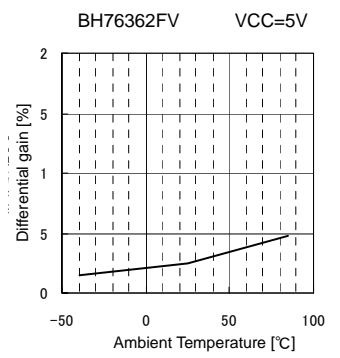

Fig.88 DG vs. Ambient Temperature

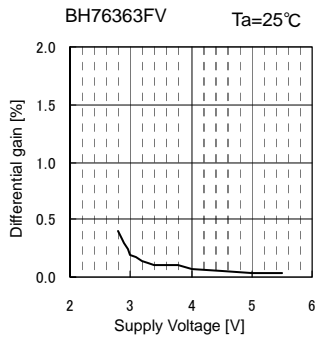

Fig.89 DG vs. Supply Voltage

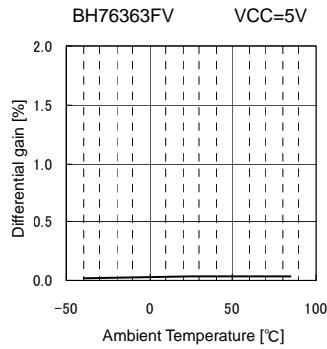

Fig.90 DG vs. Ambient Temperature

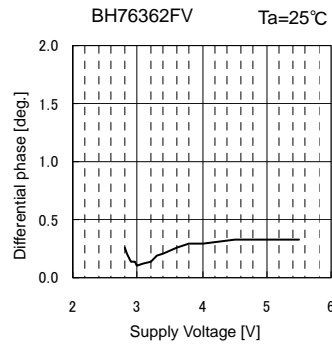

Fig.91 DP vs. Supply Voltage

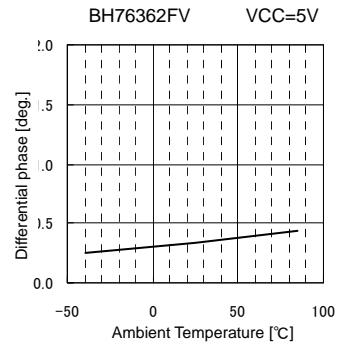

Fig.92 DP vs. Ambient Temperature

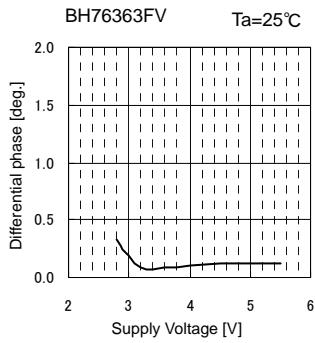

Fig.93 DP vs. Supply Voltage

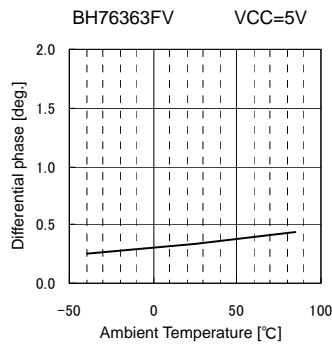

Fig.94 DP vs. Ambient Temperature

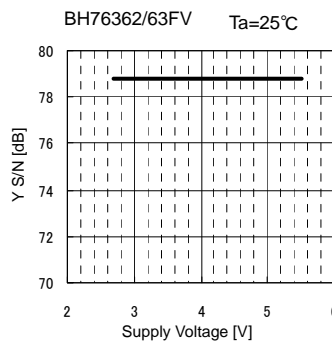

Fig.95  $SN_{\gamma}$  vs. Supply Voltage

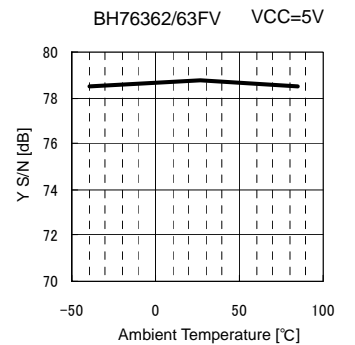

Fig.96  $SN_{\gamma}$  vs. Ambient Temperature

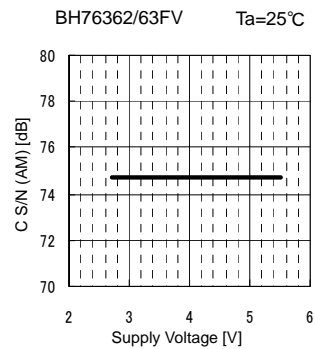

Fig.97  $SN_{CA}$  vs. Supply Voltage

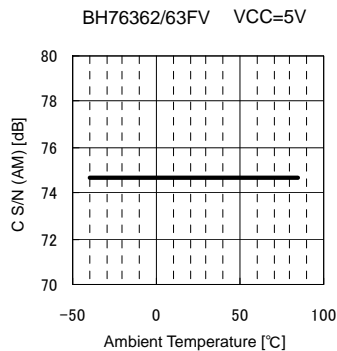

Fig.98  $SN_{CA}$  vs. Ambient Temperature

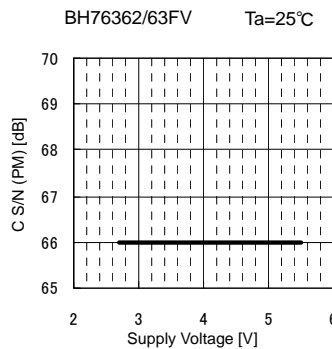

Fig.99  $SN_{CP}$  vs. Supply Voltage

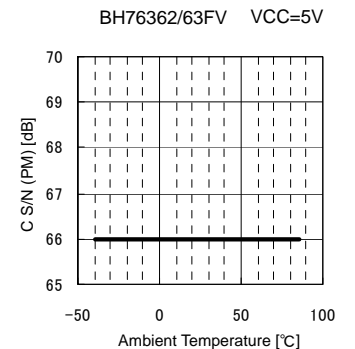
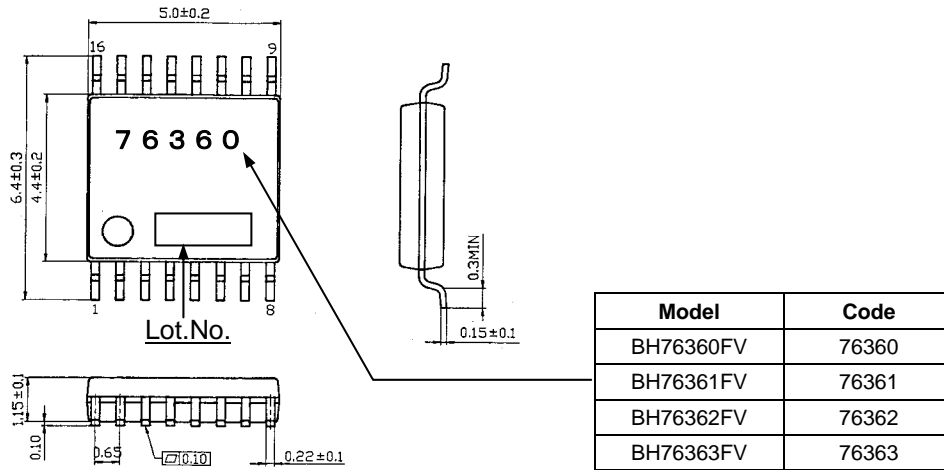

Fig.100  $SN_{CP}$  vs. Ambient Temperature

● External dimensions and label codes



SSOP-B16 (unit: mm)

Fig.101 External Dimensions of BH7636xFV Series Package

● When used with 3-input, 1-output video switch BH7633xFVM

Fig. 14 above shows an application example in which two of these ICs are used. When the similar IC models BH7633xFVM and BH7636xFV are used at the same time, the type of configuration shown below can be combined. In such cases, input coupling capacitors can be used, as in the application example in Fig. 14.

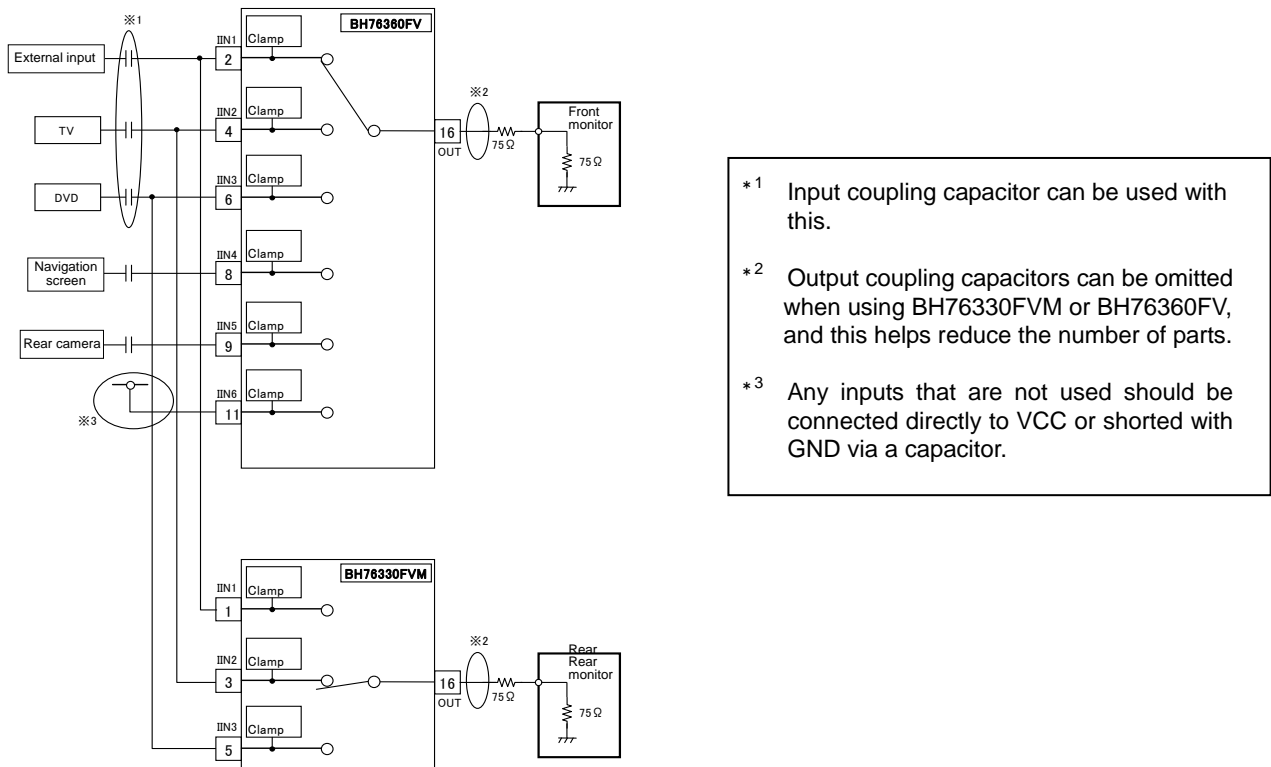
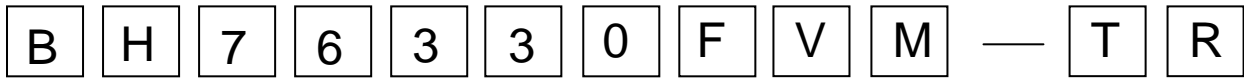

Fig.102 Application Example in which BH76330FVM and BH76360FV Are Used Concurrently

For details of BH7633xFVM, see the BH7633xFVM Series Application Notes.

● Selection of order type



Part No.  
 BH76330FVM    BH76332FVM  
 BH76331FVM    BH76333FVM  
 BH76360FV     BH76362FV  
 BH76361FV     BH76363FV

Tape and Reel information  
 TR  
 E2

**MSOP8**

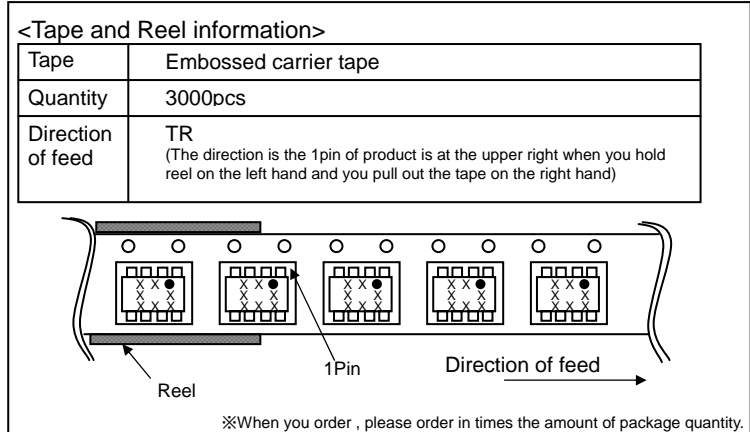
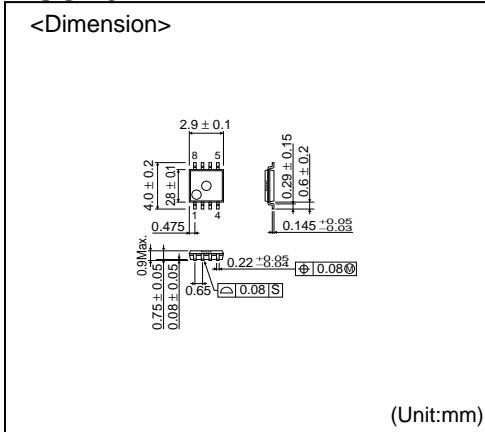

**SSOP-B16**

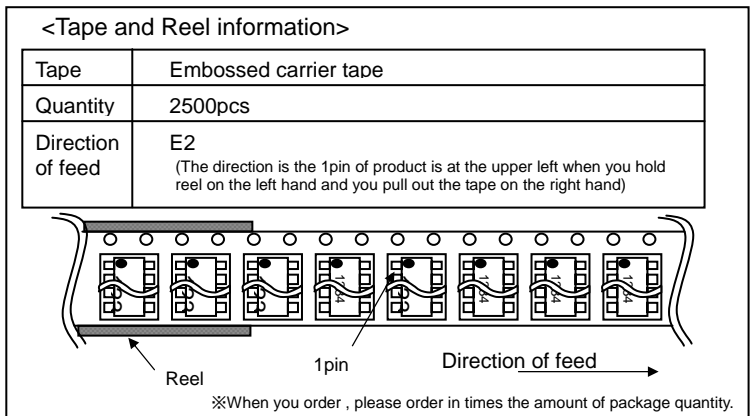
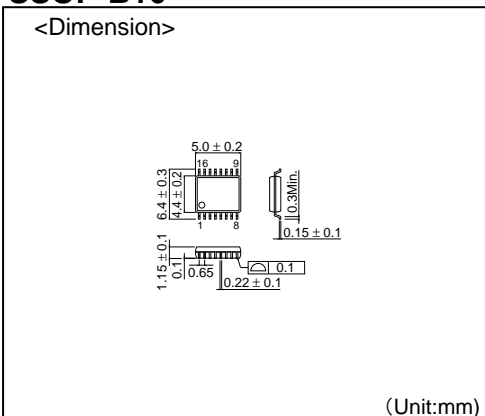



# Notice

## Precaution on using ROHM Products

- Our Products are designed and manufactured for application in ordinary electronic equipments (such as AV equipment, OA equipment, telecommunication equipment, home electronic appliances, amusement equipment, etc.). If you intend to use our Products in devices requiring extremely high reliability (such as medical equipment <sup>(Note 1)</sup>, transport equipment, traffic equipment, aircraft/spacecraft, nuclear power controllers, fuel controllers, car equipment including car accessories, safety devices, etc.) and whose malfunction or failure may cause loss of human life, bodily injury or serious damage to property ("Specific Applications"), please consult with the ROHM sales representative in advance. Unless otherwise agreed in writing by ROHM in advance, ROHM shall not be in any way responsible or liable for any damages, expenses or losses incurred by you or third parties arising from the use of any ROHM's Products for Specific Applications.

(Note1) Medical Equipment Classification of the Specific Applications

JAPAN	USA	EU	CHINA
CLASS III	CLASS III	CLASS II b	CLASS III
CLASS IV		CLASS III	

- ROHM designs and manufactures its Products subject to strict quality control system. However, semiconductor products can fail or malfunction at a certain rate. Please be sure to implement, at your own responsibilities, adequate safety measures including but not limited to fail-safe design against the physical injury, damage to any property, which a failure or malfunction of our Products may cause. The following are examples of safety measures:
  - Installation of protection circuits or other protective devices to improve system safety
  - Installation of redundant circuits to reduce the impact of single or multiple circuit failure
- Our Products are designed and manufactured for use under standard conditions and not under any special or extraordinary environments or conditions, as exemplified below. Accordingly, ROHM shall not be in any way responsible or liable for any damages, expenses or losses arising from the use of any ROHM's Products under any special or extraordinary environments or conditions. If you intend to use our Products under any special or extraordinary environments or conditions (as exemplified below), your independent verification and confirmation of product performance, reliability, etc. prior to use, must be necessary:
  - Use of our Products in any types of liquid, including water, oils, chemicals, and organic solvents
  - Use of our Products outdoors or in places where the Products are exposed to direct sunlight or dust
  - Use of our Products in places where the Products are exposed to sea wind or corrosive gases, including Cl<sub>2</sub>, H<sub>2</sub>S, NH<sub>3</sub>, SO<sub>2</sub>, and NO<sub>2</sub>
  - Use of our Products in places where the Products are exposed to static electricity or electromagnetic waves
  - Use of our Products in proximity to heat-producing components, plastic cords, or other flammable items
  - Sealing or coating our Products with resin or other coating materials
  - Use of our Products without cleaning residue of flux (even if you use no-clean type fluxes, cleaning residue of flux is recommended); or Washing our Products by using water or water-soluble cleaning agents for cleaning residue after soldering
  - Use of the Products in places subject to dew condensation
- The Products are not subject to radiation-proof design.
- Please verify and confirm characteristics of the final or mounted products in using the Products.
- In particular, if a transient load (a large amount of load applied in a short period of time, such as pulse. is applied, confirmation of performance characteristics after on-board mounting is strongly recommended. Avoid applying power exceeding normal rated power; exceeding the power rating under steady-state loading condition may negatively affect product performance and reliability.
- De-rate Power Dissipation (Pd) depending on Ambient temperature (Ta). When used in sealed area, confirm the actual ambient temperature.
- Confirm that operation temperature is within the specified range described in the product specification.
- ROHM shall not be in any way responsible or liable for failure induced under deviant condition from what is defined in this document.

## Precaution for Mounting / Circuit board design

- When a highly active halogenous (chlorine, bromine, etc.) flux is used, the residue of flux may negatively affect product performance and reliability.
- In principle, the reflow soldering method must be used; if flow soldering method is preferred, please consult with the ROHM representative in advance.

For details, please refer to ROHM Mounting specification

**Precautions Regarding Application Examples and External Circuits**

1. If change is made to the constant of an external circuit, please allow a sufficient margin considering variations of the characteristics of the Products and external components, including transient characteristics, as well as static characteristics.
2. You agree that application notes, reference designs, and associated data and information contained in this document are presented only as guidance for Products use. Therefore, in case you use such information, you are solely responsible for it and you must exercise your own independent verification and judgment in the use of such information contained in this document. ROHM shall not be in any way responsible or liable for any damages, expenses or losses incurred by you or third parties arising from the use of such information.

**Precaution for Electrostatic**

This Product is electrostatic sensitive product, which may be damaged due to electrostatic discharge. Please take proper caution in your manufacturing process and storage so that voltage exceeding the Products maximum rating will not be applied to Products. Please take special care under dry condition (e.g. Grounding of human body / equipment / solder iron, isolation from charged objects, setting of ionizer, friction prevention and temperature / humidity control).

**Precaution for Storage / Transportation**

1. Product performance and soldered connections may deteriorate if the Products are stored in the places where:
  - [a] the Products are exposed to sea winds or corrosive gases, including Cl<sub>2</sub>, H<sub>2</sub>S, NH<sub>3</sub>, SO<sub>2</sub>, and NO<sub>2</sub>
  - [b] the temperature or humidity exceeds those recommended by ROHM
  - [c] the Products are exposed to direct sunshine or condensation
  - [d] the Products are exposed to high Electrostatic
2. Even under ROHM recommended storage condition, solderability of products out of recommended storage time period may be degraded. It is strongly recommended to confirm solderability before using Products of which storage time is exceeding the recommended storage time period.
3. Store / transport cartons in the correct direction, which is indicated on a carton with a symbol. Otherwise bent leads may occur due to excessive stress applied when dropping of a carton.
4. Use Products within the specified time after opening a humidity barrier bag. Baking is required before using Products of which storage time is exceeding the recommended storage time period.

**Precaution for Product Label**

QR code printed on ROHM Products label is for ROHM's internal use only.

**Precaution for Disposition**

When disposing Products please dispose them properly using an authorized industry waste company.

**Precaution for Foreign Exchange and Foreign Trade act**

Since our Products might fall under controlled goods prescribed by the applicable foreign exchange and foreign trade act, please consult with ROHM representative in case of export.

**Precaution Regarding Intellectual Property Rights**

1. All information and data including but not limited to application example contained in this document is for reference only. ROHM does not warrant that foregoing information or data will not infringe any intellectual property rights or any other rights of any third party regarding such information or data. ROHM shall not be in any way responsible or liable for infringement of any intellectual property rights or other damages arising from use of such information or data.:
2. No license, expressly or implied, is granted hereby under any intellectual property rights or other rights of ROHM or any third parties with respect to the information contained in this document.

**Other Precaution**

1. This document may not be reprinted or reproduced, in whole or in part, without prior written consent of ROHM.
2. The Products may not be disassembled, converted, modified, reproduced or otherwise changed without prior written consent of ROHM.
3. In no event shall you use in any way whatsoever the Products and the related technical information contained in the Products or this document for any military purposes, including but not limited to, the development of mass-destruction weapons.
4. The proper names of companies or products described in this document are trademarks or registered trademarks of ROHM, its affiliated companies or third parties.

**General Precaution**

1. Before you use our Products, you are requested to carefully read this document and fully understand its contents. ROHM shall not be in any way responsible or liable for failure, malfunction or accident arising from the use of any ROHM's Products against warning, caution or note contained in this document.
2. All information contained in this document is current as of the issuing date and subject to change without any prior notice. Before purchasing or using ROHM's Products, please confirm the latest information with a ROHM sales representative.
3. The information contained in this document is provided on an "as is" basis and ROHM does not warrant that all information contained in this document is accurate and/or error-free. ROHM shall not be in any way responsible or liable for any damages, expenses or losses incurred by you or third parties resulting from inaccuracy or errors of or concerning such information.