

Item	Unit	Quantity	Remarks
U1	IC	1	74VHC04
U2	IC	1	74VHC04
U3	IC	1	74VHC04
U4	IC	1	74VHC04
U5	IC	1	74VHC04
U6	IC	1	74VHC04
U7	IC	1	74VHC04
U8	IC	1	74VHC04
U9	IC	1	74VHC04
U10	IC	1	74VHC04
U11	IC	1	74VHC04
U12	IC	1	74VHC04
U13	IC	1	74VHC04
U14	IC	1	74VHC04
U15	IC	1	74VHC04
U16	IC	1	74VHC04
U17	IC	1	74VHC04
U18	IC	1	74VHC04
U19	IC	1	74VHC04
U20	IC	1	74VHC04
U21	IC	1	74VHC04

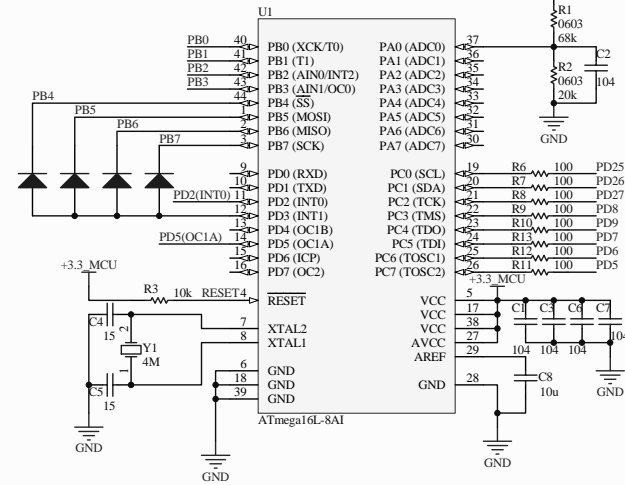

Title		
lcd_key		
Size	Number	Revision
A3		
Date:	2010-2-7	Sheet of
File:	E:\新版正式版示波器工程\lcd_key_pov\lcd_key.dwg	

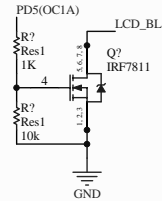
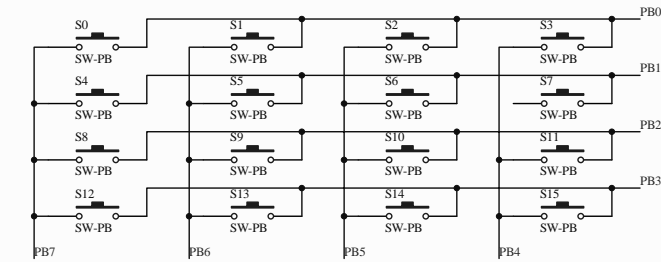
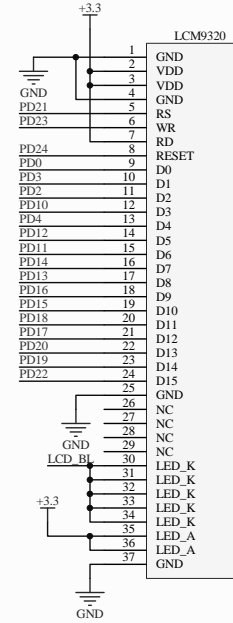
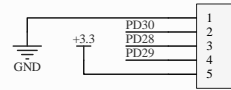
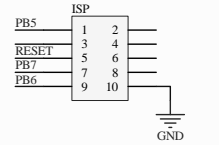
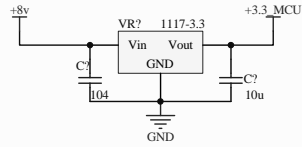
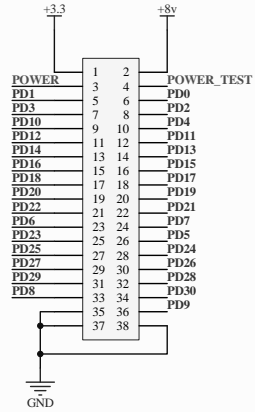
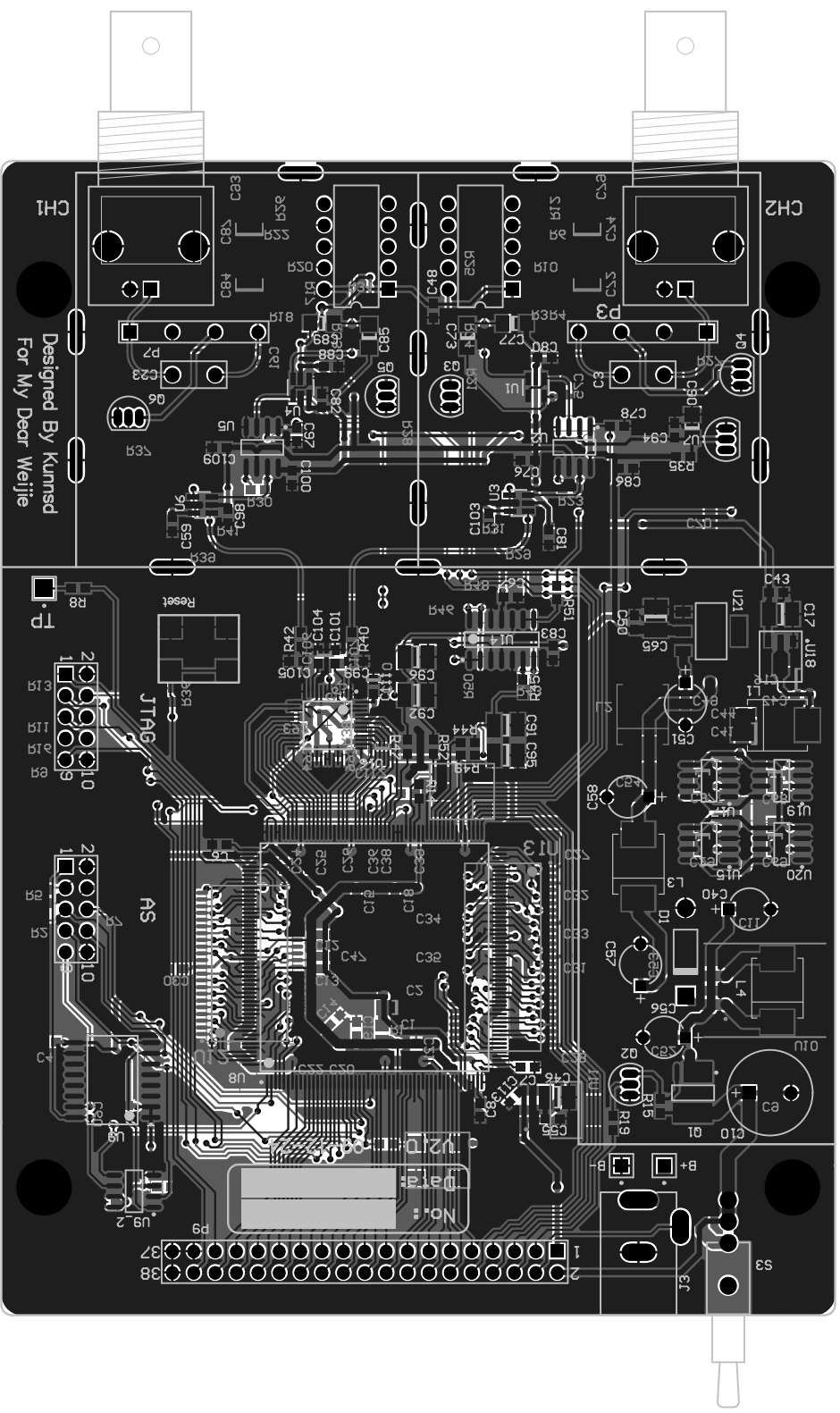

Designed By Kurnsd
For My Dear Weijie

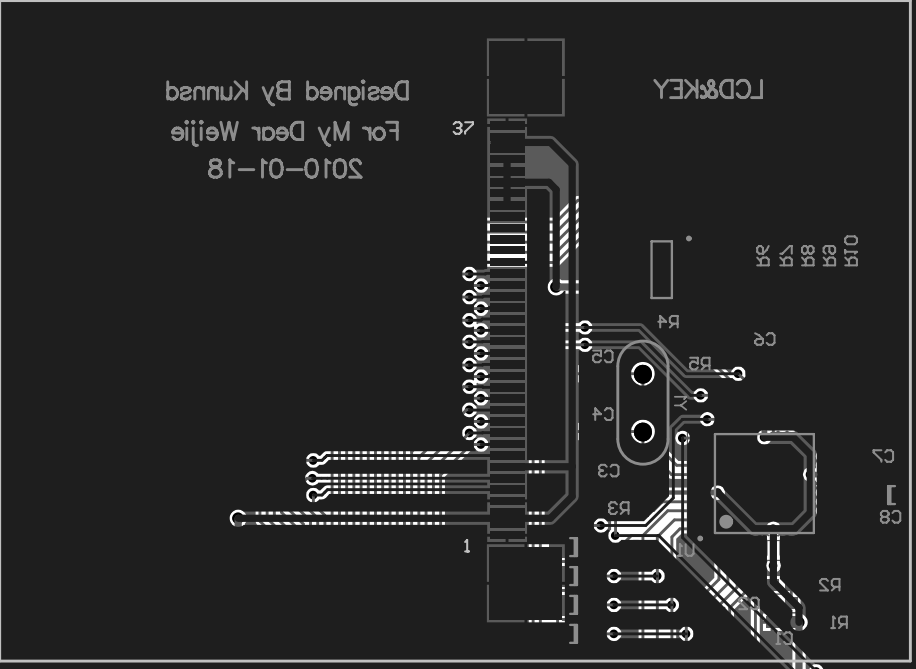

Designed By Kunnsd
 For My Dear Weijie
 2010-01-18

