

PC851

High Collector-emitter Voltage Type Photocoupler

* Lead forming type (I type) and taping reel type (P type) are also available. (PC851I/PC851P)

■ Features

1. High collector-emitter voltage
(V_{CEO} : 300V)
2. High isolation voltage between input and output (V_{iso} : 5 000V_{rms})
3. Compact dual-in-line package
4. Recognized by UL, file No. E64380

■ Applications

1. ON-OFF switching for transmission/reception circuit for telephone
2. Interface to various power supply circuits, power patch boards
3. Copiers, facsimiles
4. Output section for numerical control machines
5. Controller for SSRs, DC motors

■ Outline Dimensions

(Unit : mm)

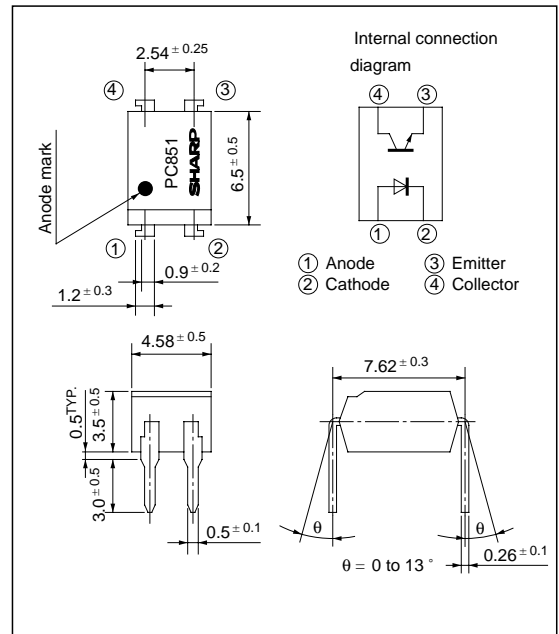

■ Absolute Maximum Ratings

($T_a = 25^\circ\text{C}$)

Parameter		Symbol	Rating	Unit
Input	Forward current	I_F	50	mA
	*1 Peak forward current	I_{FM}	1	A
	Reverse voltage	V_R	6	V
	Power dissipation	P	70	mW
Output	Collector-emitter voltage	V_{CEO}	300	V
	Emitter-collector voltage	V_{ECO}	6	V
	Collector current	I_C	50	mA
	Collector power dissipation	P_C	150	mW
Total power dissipation		P_{tot}	200	mW
*2 Isolation voltage		V_{iso}	5 000	V _{rms}
Operating temperature		T_{opr}	- 25 to + 100	$^\circ\text{C}$
Storage temperature		T_{stg}	- 55 to + 125	$^\circ\text{C}$
*3 Soldering temperature		T_{sol}	260	$^\circ\text{C}$

*1 Pulse width $\leq 100\mu\text{s}$, Duty ratio : 0.001

*2 40 to 60% RH, AC for 1 minute

*3 For 10 seconds

■ Electro-optical Characteristics

(T_a = 25°C)

Parameter		Symbol	Conditions	MIN.	TYP.	MAX.	Unit		
Input	Forward voltage	V _F	I _F = 20mA	-	1.2	1.4	V		
	Reverse current	I _R	V _R = 4V	-	-	10	μA		
	Terminal capacitance	C _t	V = 0, f = 1kHz	-	30	250	pF		
Output	Collector dark current	I _{CEO}	V _{CE} = 200V, I _F = 0	-	-	10 ⁻⁶	A		
Transfer characteristics	Current transfer ratio	CTR	I _F = 5mA, V _{CE} = 5V	40	80	-	%		
	Collector-emitter saturation voltage	V _{CE(sat)}	I _F = 20mA, I _C = 1mA	-	0.1	0.3	V		
	Isolation resistance	R _{ISO}	DC500V, 40 to 60% RH	5 × 10 ¹⁰	10 ¹¹	-	Ω		
	Floating capacitance	C _f	V = 0, f = 1MHz	-	0.6	1.0	pF		
	Cut-off frequency	Response time	Rise time	t _r	V _{CE} = 2V, I _C = 2mA	-	4	10	μs

Fig. 1 Forward Current vs. Ambient Temperature

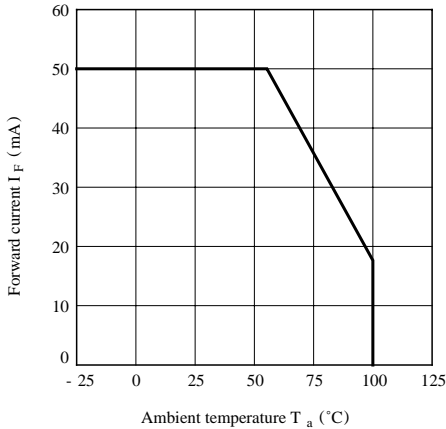

Fig. 2 Collector Power Dissipation vs. Ambient Temperature

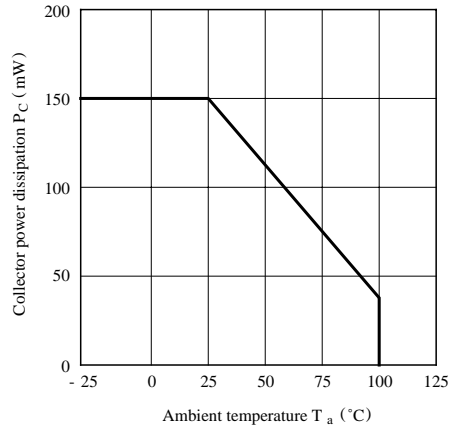

Fig. 3 Peak Forward Current vs. Duty Ratio

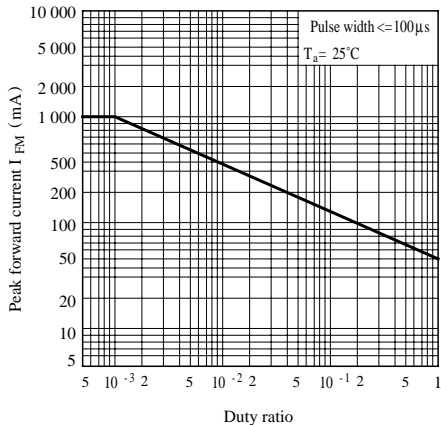

Fig. 4 Forward Current vs. Forward Voltage

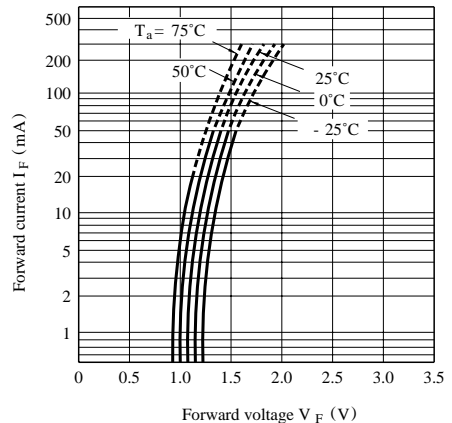

Fig. 5 Current Transfer Ratio vs. Forward Current

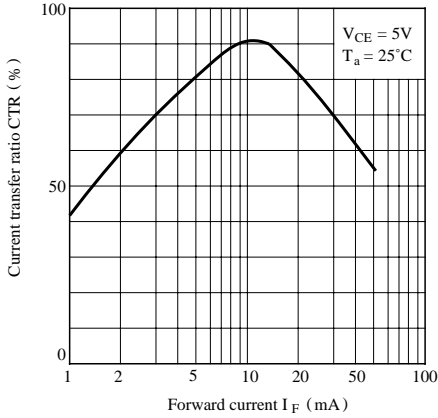

Fig. 6 Collector Current vs. Collector-emitter Voltage

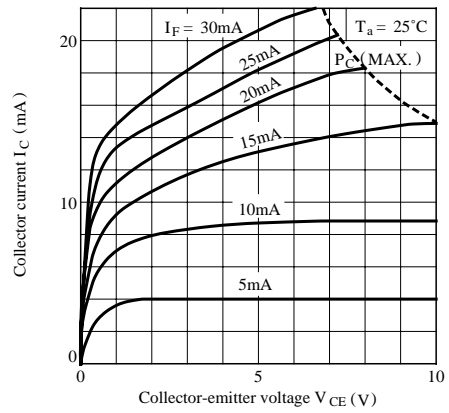

Fig. 7 Relative Current Transfer Ratio vs. Ambient Temperature

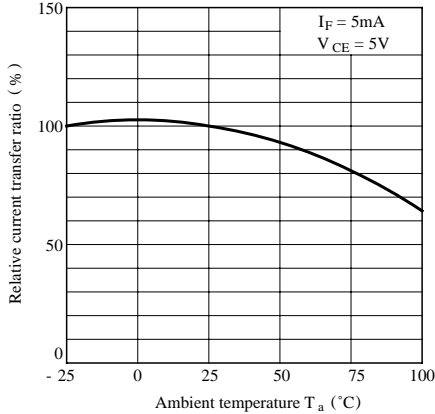

Fig. 8 Collector-emitter Saturation Voltage vs. Ambient Temperature

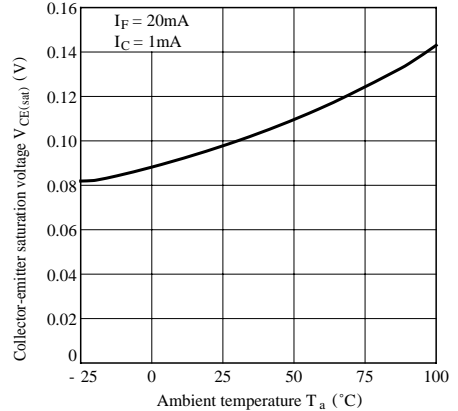

Fig. 9 Collector Dark Current vs. Ambient Temperature

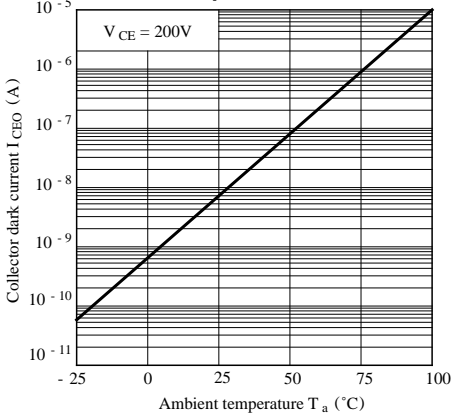
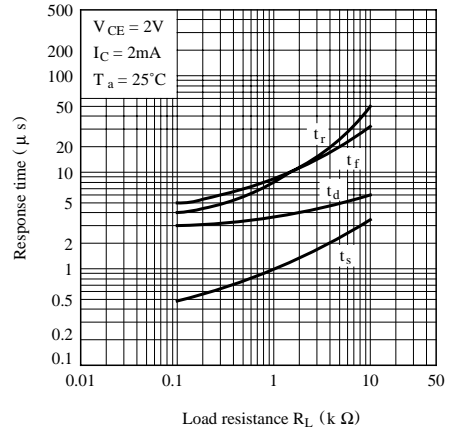

Fig.10 Response Time vs. Load Resistance



Test Circuit for Response Time

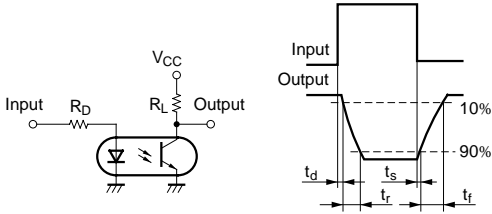

Fig.11 Frequency Response

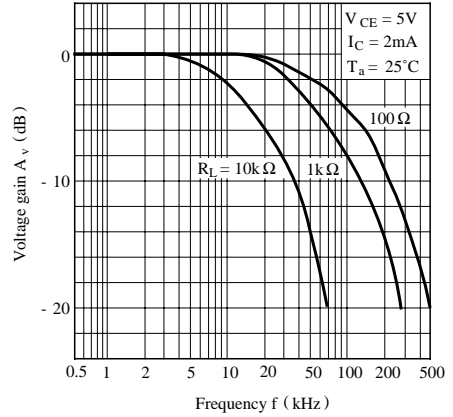
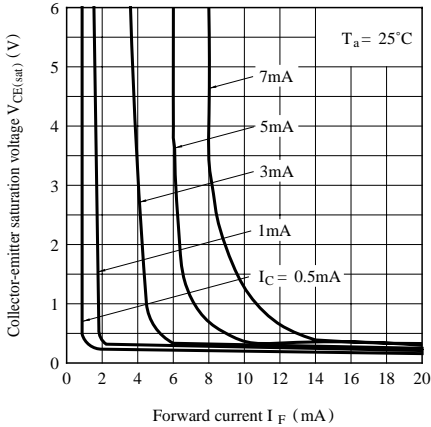
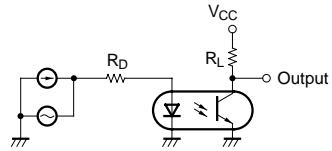

Fig.12 Collector-emitter Saturation Voltage vs. Forward Current



Test Circuit for Frequency Response



● Please refer to the chapter “Precautions for Use”

This datasheet has been download from:

www.datasheetcatalog.com

Datasheets for electronics components.