



EDISON OPTO CORPORATION

Edixeon ***3W High Power LED***

DATE : 2005/05/31

VERSION : 2.2

Device No : 3-RD-01-E0002



EDISON OPTO CORPORATION
*Office:5F, No. 800, Chung-Cheng Rd,
Chung-Ho, Taipei 235, Taiwan, R.O.C.*

*Tel: 886-2-8227-6996
Fax: 886-2-8227-6997
<http://www.edison-opto.com.tw>*

Features

- Long operating life (up to 100,000 hours)
- More Energy Efficient than incandescent and most halogen lamps
- Low forward voltage operated
- Instant light (less than 100 ns)
- No UV

Typical Applications

- Reading lights
- Portable flashlight
- Uplighters and Downlighters
- Bollards / Security / Garden lighting
- Indoor and Outdoor Commercial lighting
- LCD Backlights / Light guides
- General lighting

Lambertian Package Outlines

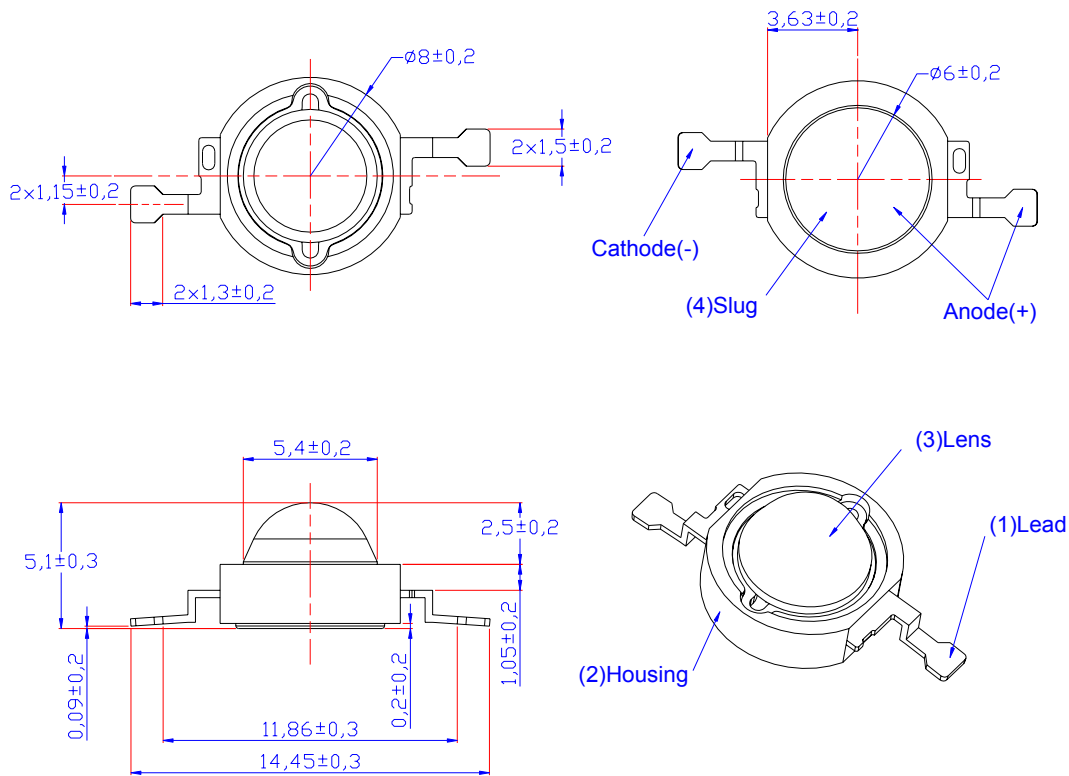

Unit: mm

Note: The (4)slug has polarity (+ Anode) for Red 、 Red orange 、 Amber.
But no polarity for other.(True green 、 Blue 、 White 、 Warm White)

Absolute Maximum Ratings

Parameter	Symbol	Rating	Units
DC Forward Current	I_F	700	mA
Peak pulse current; ($t_p \leq 100 \mu s$, Duty cycle=0.005) ^{*1}	I_{pulse}	1000	mA
Reverse Voltage	V_R	5	V
LED junction Temperature (at 700 mA)	T_j	125	°C
Operating Temperature	T_{opr}	-30 ~ +110	°C
Storage Temperature	T_{stg}	-40 ~ +120	°C
Manual Soldering Time at 260°C (Max.)	T_{sol}	5	seconds

1. Duty cycle:

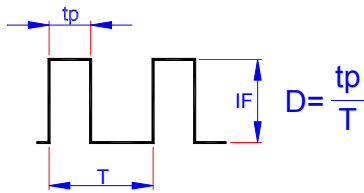

Luminous Flux

Characteristics at $I_F=700mA(T_a=25^\circ C)$:

Lens Item	Part Name	Color	Flux			Units
			min.	typ.	Max.	
	EDEW-3LA5	White	51.2	60	--	lm
	EDEX-3LA5	Warm White	39.4	45	--	lm
	EDER-3LA3	Red	39.4	50	--	lm
Lambertian	EDEO-3LA3	Red Orange	51.2	60	--	lm
	EDEA-3LA3	Amber	39.4	55	--	lm
	EDET-3LA1	True Green	51.2	55	--	lm
	EDEB-3LA5	Blue	13.8	20	--	lm

Forward Voltage

Characteristics at $I_F=700mA(T_a=25^\circ C)$:

Lens Item	Part Name	Color	V_F			Units
			min.	typ.	Max.	
	EDEW-3LA5	White	3.4	--	4.9	V
	EDEX-3LA5	Warm White	3.4	--	4.9	V
	EDER-3LA3	Red	2.0	--	3.0	V
Lambertian	EDEO-3LA3	Red Orange	2.0	--	3.0	V
	EDEA-3LA3	Amber	2.0	--	3.0	V
	EDET-3LA1	True Green	2.8	--	4.0	V
	EDEB-3LA5	Blue	3.4	--	4.9	V

Wavelength or Color Temperature
Characteristics at $I_F=700mA(T_a=25^\circ C)$:

Lens Item	Part Name	Color	$\lambda D/CCT$			Units
			Min.	Typ.	Max.	
	EDEW-3LA5	White	5000	--	8000	<i>K</i>
	EDEX-3LA5	Warm White	2800	--	3800	<i>K</i>
	EDER-3LA3	Red	620	--	630	<i>nm</i>
Lambertian	EDEO-3LA3	Red Orange	610	--	620	<i>nm</i>
	EDEA-3LA3	Amber	585	--	595	<i>nm</i>
	EDET-3LA1	True Green	515	--	535	<i>nm</i>
	EDEB-3LA5	Blue	460	--	475	<i>nm</i>

Thermal Resistance Junction to Board
Characteristics at $I_F=700mA(T_a=25^\circ C)$:

Lens Item	Part Name	Color	$R\theta_{J-B}$			Units
			Min.	Typ.	Max.	
	EDEW-3LA5	White	--	20	--	$^\circ C/W$
	EDEX-3LA5	Warm White	--	20	--	$^\circ C/W$
	EDER-3LA3	Red	--	20	--	$^\circ C/W$
Lambertian	EDEO-3LA3	Red Orange	--	20	--	$^\circ C/W$
	EDEA-3LA3	Amber	--	20	--	$^\circ C/W$
	EDET-3LA1	True Green	--	20	--	$^\circ C/W$
	EDEB-3LA5	Blue	--	20	--	$^\circ C/W$

Temperature Coefficient Of Forward Voltage
Characteristics at $I_F=700mA(T_a=25^\circ C)$:

Lens Item	Part Name	Color	$\Delta V_F/\Delta T$			Units
			Min.	Typ.	Max.	
	EDEW-3LA5	White	--	-2	--	mV/°C
	EDEX-3LA5	Warm White	--	-2	--	mV/°C
	EDER-3LA3	Red	--	-2	--	mV/°C
Lambertian	EDEO-3LA3	Red Orange	--	-2	--	mV/°C
	EDEA-3LA3	Amber	--	-2	--	mV/°C
	EDET-3LA1	True Green	--	-2	--	mV/°C
	EDEB-3LA5	Blue	--	-2	--	mV/°C

Reverse Current
Characteristics at $V_R=5V(T_a=25^\circ C)$:

Lens Item	Part Name	Color	$I_R(V_R=5V)$			Units
			Min.	Typ.	Max.	
	EDEW-3LA5	White	--	--	50	μA
	EDEX-3LA5	Warm White	--	--	50	μA
	EDER-3LA3	Red	--	--	50	μA
Lambertian	EDEO-3LA3	Red Orange	--	--	50	μA
	EDEA-3LA3	Amber	--	--	50	μA
	EDET-3LA1	True Green	--	--	50	μA
	EDEB-3LA5	Blue	--	--	50	μA

Emission Angle
Characteristics at $I_F=350mA(T_a=25^\circ C)$:

Lens Item	Part Name	Color	2 θ ^{1/2}			Units
			Min.	Typ.	Max.	
Lambertian	EDEW-3LA5	White	--	140	--	Degrees
	EDEX-3LA5	Warm White	--	140	--	Degrees
	EDER-3LA3	Red	--	120	--	Degrees
	EDEO-3LA3	Red Orange	--	120	--	Degrees
	EDEA-3LA3	Amber	--	120	--	Degrees
	EDET-3LA1	True Green	--	140	--	Degrees
	EDEB-3LA5	Blue	--	140	--	Degrees

Note

1. Flux is measured with an accuracy of $\pm 15\%$.
2. CCT selection acc. to CCT groups and an accuracy of $\pm 400K$
3. Forward Voltage is measured with an accuracy of $\pm 0.2V$.
4. Wavelength is measured with an accuracy of $\pm 3nm$
5. Angle is measured with an accuracy of ± 15 degree

Typical Radiation Pattern for Lambertian

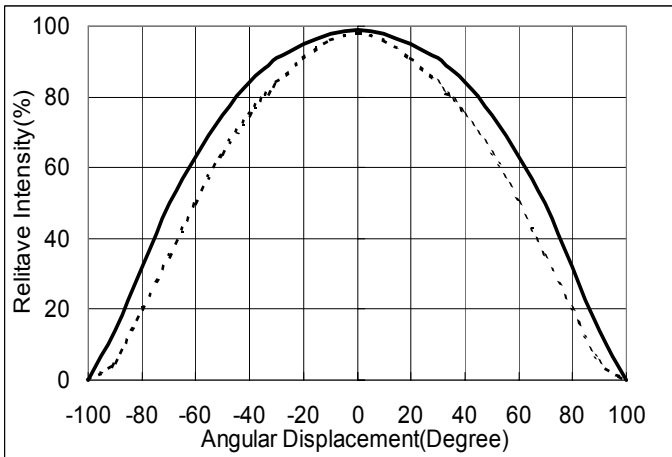

Operating Current & Ambient Temperature

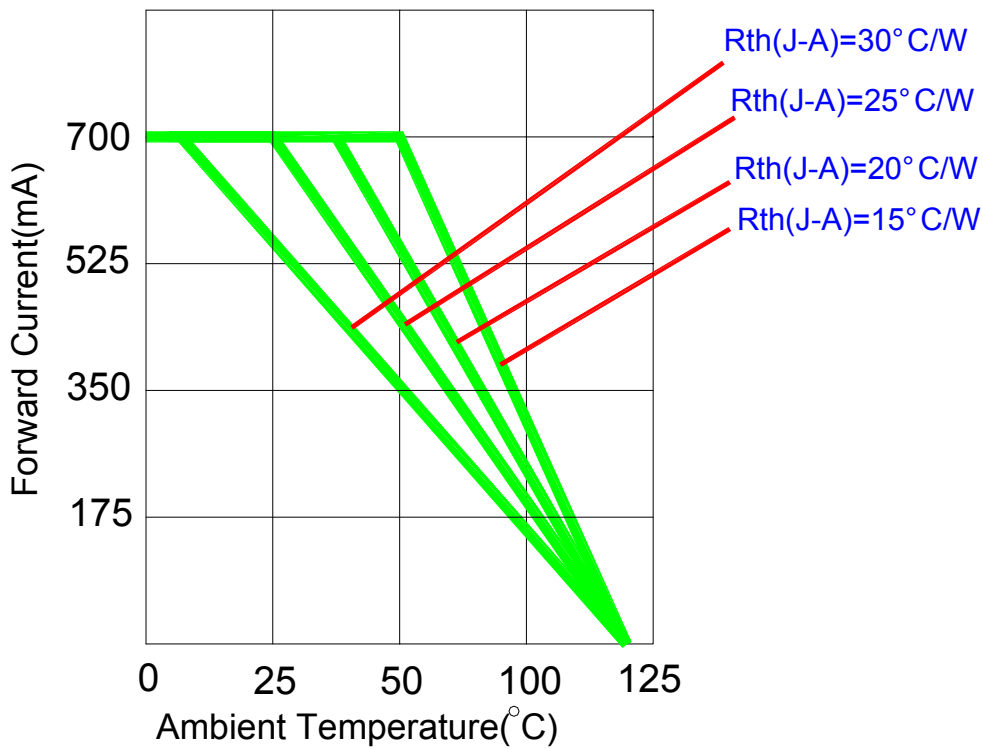

Electrical & Optical Curves

Wavelength Spectrum of White

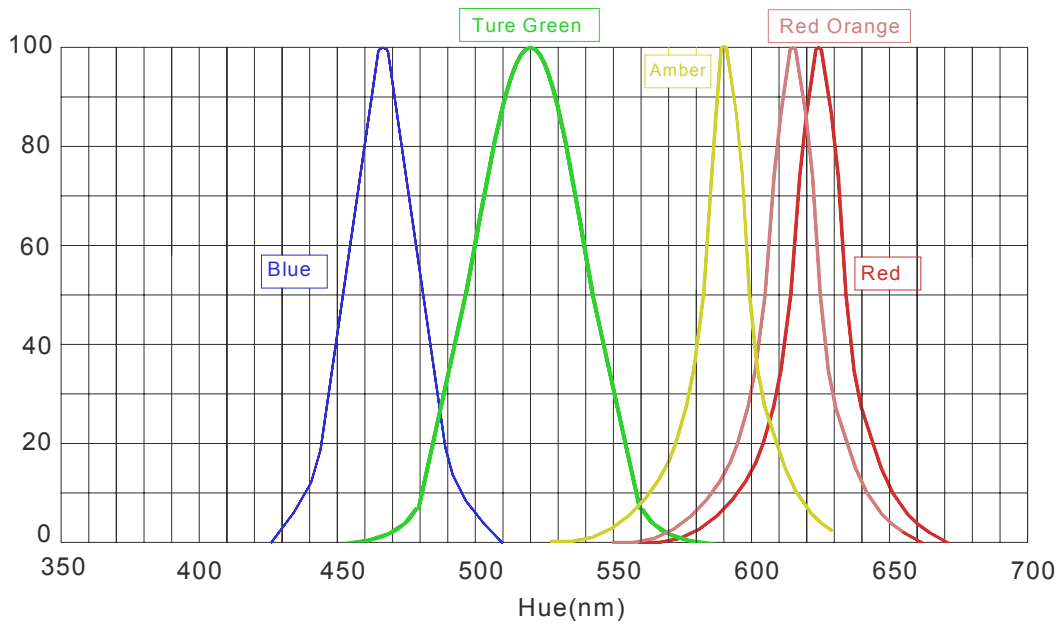
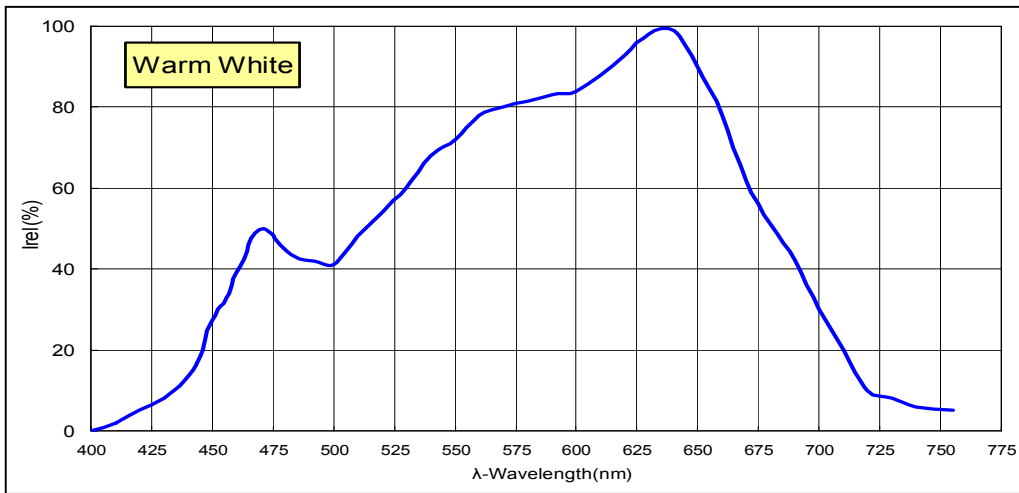
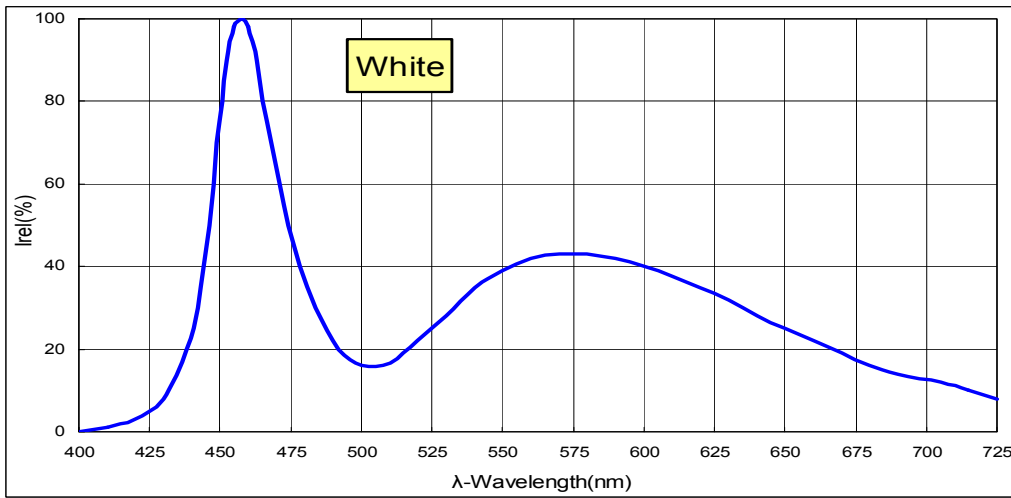

Revision History

Version	Page	Subjects (major changes since last revision)	Date
2.2	4	1. Modified Part No.:EDET-3LA2 → EDET-3LA1 2.Modified EDET-3LA1 V_F (Min.):3.4V → 2.8V (Max):4.9V → 4.9V	2005/05/31